

Intel[®] Atom[™] Processor E6xx Series

Datasheet

July 2011

Revision 004US



INFORMATION IN THIS DOCUMENT IS PROVIDED IN CONNECTION WITH INTEL® PRODUCTS. NO LICENSE, EXPRESS OR IMPLIED, BY ESTOPPEL OR OTHERWISE, TO ANY INTELLECTUAL PROPERTY RIGHTS IS GRANTED BY THIS DOCUMENT. EXCEPT AS PROVIDED IN INTEL'S TERMS AND CONDITIONS OF SALE FOR SUCH PRODUCTS, INTEL ASSUMES NO LIABILITY WHATSOEVER, AND INTEL DISCLAIMS ANY EXPRESS OR IMPLIED WARRANTY, RELATING TO SALE AND/OR USE OF INTEL PRODUCTS INCLUDING LIABILITY OR WARRANTIES RELATING TO FITNESS FOR A PARTICULAR PURPOSE, MERCHANTABILITY, OR INFRINGEMENT OF ANY PATENT, COPYRIGHT OR OTHER INTELLECTUAL PROPERTY RIGHT.

UNLESS OTHERWISE AGREED IN WRITING BY INTEL, THE INTEL PRODUCTS ARE NOT DESIGNED NOR INTENDED FOR ANY APPLICATION IN WHICH THE FAILURE OF THE INTEL PRODUCT COULD CREATE A SITUATION WHERE PERSONAL INJURY OR DEATH MAY OCCUR.

Intel may make changes to specifications and product descriptions at any time, without notice. Designers must not rely on the absence or characteristics of any features or instructions marked "reserved" or "undefined." Intel reserves these for future definition and shall have no responsibility whatsoever for conflicts or incompatibilities arising from future changes to them. The information here is subject to change without notice. Do not finalize a design with this information.

The products described in this document may contain design defects or errors known as errata which may cause the product to deviate from published specifications. Current characterized errata are available on request.

Contact your local Intel sales office or your distributor to obtain the latest specifications and before placing your product order.

Copies of documents which have an order number and are referenced in this document, or other Intel literature, may be obtained by calling 1-800-548-4725, or go to: http://www.intel.com/#/en_US_01.

Intel processor numbers are not a measure of performance. Processor numbers differentiate features within each processor family, not across different processor families. Go to: <http://www.intel.com/products/processor%5Fnumber/> for details.

α Intel® Hyper-Threading Technology requires a computer system with a processor supporting Intel® HT Technology and an Intel® HT Technology-enabled chipset, BIOS and operating system. Performance will vary depending on the specific hardware and software you use. For more information including details on which processors support Intel® HT Technology, see http://www.intel.com/products/ht/hyperthreading_more.htm.

β Intel® High Definition Audio requires a system with an appropriate Intel® chipset and a motherboard with an appropriate CODEC and the necessary drivers installed. System sound quality will vary depending on actual implementation, controller, CODEC, drivers and speakers. For more information about Intel® HD audio, refer to <http://www.intel.com/>.

χ 64-bit computing on Intel® architecture requires a computer system with a processor, chipset, BIOS, operating system, device drivers and applications enabled for Intel® 64 architecture. Performance will vary depending on your hardware and software configurations. Consult with your system vendor for more information.

δ Intel® Virtualization Technology requires a computer system with an enabled Intel® processor, BIOS, virtual machine monitor (VMM) and, for some uses, certain computer system software enabled for it. Functionality, performance or other benefits will vary depending on hardware and software configurations and may require a BIOS update. Software applications may not be compatible with all operating systems. Please check with your application vendor.

ϵ The original equipment manufacturer must provide Intel® Trusted Platform Module (Intel® TPM) functionality, which requires an Intel® TPM-supported BIOS. Intel® TPM functionality must be initialized and may not be available in all countries.

θ For Enhanced Intel SpeedStep® Technology, see the <http://processorfinder.intel.com/> or contact your Intel representative for more information.

I²C* is a two-wire communications bus/protocol developed by Philips. SMBus is a subset of the I²C* bus/protocol and was developed by Intel. Implementations of the I²C* bus/protocol may require licenses from various entities, including Philips Electronics N.V. and North American Philips Corporation.

BunnyPeople, Celeron, Celeron Inside, Centrino, Centrino Inside, Core Inside, i960, Intel, the Intel logo, Intel AppUp, Intel Atom, Intel Atom Inside, Intel Core, Intel Inside, the Intel Inside logo, Intel NetBurst, Intel NetMerge, Intel NetStructure, Intel SingleDriver, Intel SpeedStep, Intel Sponsors of Tomorrow., the Intel Sponsors of Tomorrow. logo, Intel StrataFlash, Intel Viiv, Intel vPro, Intel XScale, InTru, the InTru logo, InTru soundmark, Itanium, Itanium Inside, MCS, MMX, Moblin, Pentium, Pentium Inside, skool, the skool logo, Sound Mark, The Journey Inside, vPro Inside, VTune, Xeon, and Xeon Inside are trademarks of Intel Corporation in the U.S. and other countries.

*Other names and brands may be claimed as the property of others.

Copyright © 2011, Intel Corporation. All rights reserved.

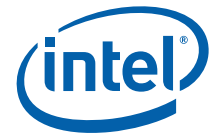

Contents

1.0	Introduction	23
1.1	Terminology	23
1.2	Reference Documents	25
1.3	Components Overview	25
1.3.1	Low-Power Intel® Architecture Core	26
1.3.2	System Memory Controller	27
1.3.3	Graphics	27
1.3.4	Video Decode	27
1.3.5	Video Encode	27
1.3.6	Display Interfaces	27
1.3.6.1	LVDS Interface	28
1.3.6.2	Serial DVO (SDVO) Display Interface	28
1.3.7	PCI Express*	28
1.3.8	LPC Interface	28
1.3.9	Intel® High Definition Audio ^β (Intel® HD Audio ^β) Controller	28
1.3.10	SMBus Host Controller	29
1.3.11	General Purpose I/O (GPIO)	29
1.3.12	Serial Peripheral Interface (SPI)	29
1.3.13	Power Management	29
1.3.14	Watchdog Timer (WDT)	29
1.3.15	Real Time Clock (RTC)	29
1.3.16	Package	29
1.3.17	Intel® Atom™ Processor E6xx Series SKU	30
2.0	Signal Description	31
2.1	System Memory Signals	32
2.2	Integrated Display Interfaces	33
2.2.1	LVDS Signals	33
2.2.2	Serial Digital Video Output (SDVO) Signals	34
2.3	PCI Express* Signals	35
2.4	Intel® High Definition Audio ^β Interface Signals	35
2.5	LPC Interface Signals	36
2.6	SMBus Interface Signals	36
2.7	SPI Interface Signals	36
2.8	Power Management Interface Signals	37
2.9	Real Time Clock Interface Signals	38
2.10	JTAG and Debug Interface	39
2.11	Miscellaneous Signals and Clocks	40
2.12	General Purpose I/O	43
2.13	Functional Straps	43
2.14	Power and Ground Signals	44
3.0	Pin States	47
3.1	Pin Reset States	47
3.2	System Memory Signals	47
3.3	Integrated Display Interfaces	48
3.3.1	LVDS Signals	48
3.3.2	Serial Digital Video Output (SDVO) Signals	48
3.4	PCI Express* Signals	49
3.5	Intel® High Definition Audio ^β Interface Signals	49
3.6	LPC Interface Signals	50
3.7	SMBus Interface Signals	50



- 3.8 SPI Interface Signals.....50
- 3.9 Power Management Interface Signals50
- 3.10 Real Time Clock Interface Signals51
- 3.11 JTAG and Debug Interface51
- 3.12 Miscellaneous Signals and Clocks51
- 3.13 General Purpose I/O.....52
- 3.14 Integrated Termination Resistors52
- 4.0 System Clock Domains53**
- 5.0 Register and Memory Mapping55**
 - 5.1 Address Map55
 - 5.2 Introduction.....55
 - 5.3 System Memory Map.....56
 - 5.3.1 I/O Map.....58
 - 5.3.1.1 Fixed I/O Address Range.....58
 - 5.3.1.2 Variable I/O Address Range.....59
 - 5.3.2 PCI Devices and Functions59
 - 5.4 Register Access Method60
 - 5.4.1 Direct Register Access60
 - 5.4.1.1 Hard Coded IO Access.....60
 - 5.4.1.2 IO BAR61
 - 5.4.1.3 Hard-Coded Memory Access.....61
 - 5.4.1.4 Memory BAR.....61
 - 5.4.2 Indirect Register Access.....61
 - 5.4.2.1 PCI Config Space.....61
 - 5.5 Bridging and Configuration.....62
 - 5.5.1 Root Complex Topology Capability Structure.....62
 - 5.5.1.1 Offset 0000h: RCTCL – Root Complex Topology Capabilities List62
 - 5.5.1.2 Offset 0004h: ESD – Element Self Description.....63
 - 5.5.1.3 Offset 0010h: HDD – Intel® High Definition Audio^β Description.....63
 - 5.5.1.4 Offset 0018h: HDBA – Intel® High Definition Audio^β Base Address ...63
 - 5.5.2 Interrupt Pin Configuration.....64
 - 5.5.2.1 Offset 3100h: D31IP – Device 31 Interrupt Pin.....64
 - 5.5.2.2 Offset 3110h: D27IP – Device 27 Interrupt Pin.....64
 - 5.5.2.3 Offset 3118h: D02IP – Device 2 Interrupt Pin.....65
 - 5.5.2.4 Offset 3120h: D26IP – Device 26 Interrupt Pin.....65
 - 5.5.2.5 Offset 3124h: D25IP – Device 25 Interrupt Pin.....65
 - 5.5.2.6 Offset 3128h: D24IP – Device 24 Interrupt Pin.....65
 - 5.5.2.7 Offset 312Ch: D23IP – Device 23 Interrupt Pin.....66
 - 5.5.2.8 Offset 3130h: D03IP – Device 3 Interrupt Pin.....66
 - 5.5.3 Interrupt Route Configuration.....66
 - 5.5.3.1 Offset 3140h: D31IR – Device 31 Interrupt Route.....66
 - 5.5.3.2 Offset 3148h: D27IR – Device 27 Interrupt Route.....67
 - 5.5.3.3 Offset 314Ah: D26IR – Device 26 Interrupt Route.....67
 - 5.5.3.4 Offset 314Ch: D25IR – Device 25 Interrupt Route68
 - 5.5.3.5 Offset 314Eh: D24IR – Device 24 Interrupt Route.....68
 - 5.5.3.6 Offset 3150h: D23IR – Device 23 Interrupt Route.....68
 - 5.5.3.7 Offset 3160h: D02IR – Device 2 Interrupt Route69
 - 5.5.3.8 Offset 3162h: D03IR – Device 3 Interrupt Route69
 - 5.5.4 General Configuration.....69
 - 5.5.4.1 Offset 3400h: RC – RTC Configuration.....69
 - 5.5.4.2 Offset 3410h: BNT– Boot Configuration70
- 6.0 Memory Controller71**
 - 6.1 Overview71
 - 6.1.1 DRAM Frequencies and Data Rates.....71
 - 6.2 DRAM Burst Length.....71



6.3	DRAM Partial Writes.....	71
6.4	DRAM Power Management.....	71
6.4.1	Powerdown Modes.....	72
6.4.2	Self Refresh Mode.....	72
6.4.3	Dynamic Self Refresh Mode.....	72
6.4.4	Page Management.....	72
6.5	Refresh Mode.....	72
6.6	Supported DRAM Configurations.....	73
6.7	Supported DRAM Devices.....	74
6.8	Supported Rank Configurations.....	74
6.9	Address Mapping and Decoding.....	75
7.0	Graphics, Video, and Display.....	77
7.1	Chapter Contents.....	77
7.2	Overview.....	77
7.2.1	3D Graphics.....	77
7.2.2	Shading Engine Key Features.....	78
7.2.3	Vertex Processing.....	79
7.2.3.1	Vertex Transform Stages.....	79
7.2.3.2	Lighting Stages.....	79
7.2.4	Pixel Processing.....	80
7.2.4.1	Hidden Surface Removal.....	80
7.2.4.2	Applying Textures and Shading.....	80
7.2.4.3	Final Pixel Formatting.....	80
7.2.5	Unified Shader.....	80
7.2.6	Multi Level Cache.....	81
7.3	Video Encode.....	81
7.3.1	Supported Input Formats.....	81
7.3.1.1	Encoding Pipeline.....	81
7.3.1.2	Encode Codec Support.....	82
7.3.1.3	Encode Specifications Supported.....	82
7.4	Video Decode.....	83
7.4.1	Entropy Coding.....	83
7.4.1.1	Motion Compensation.....	84
7.4.1.2	Deblocking.....	84
7.4.1.3	Output Reference Frame Storage Format.....	84
7.4.1.4	Pixel Format.....	85
7.5	Display.....	85
7.5.1	Display Output Stages.....	87
7.5.1.1	Planes.....	87
7.5.1.2	Display Pipes.....	88
7.5.2	Display Ports.....	88
7.5.2.1	LVDS Port.....	89
7.5.2.2	LVDS Backlight Control.....	90
7.5.2.3	SDVO Digital Display Port.....	90
7.5.2.4	SDVO DVI/HDMI.....	91
7.6	Control Bus.....	91
7.7	Configuration Registers.....	92
7.7.1	D2:F0 PCI Configuration Registers.....	92
7.7.2	D3:F0 PCI Configuration Registers.....	104
7.7.2.1	Offset 00h: ID – Identifiers.....	105
7.7.2.2	Offset 04h: CMD – PCI Command.....	105
7.7.2.3	Offset 06h: STS - PCI Status.....	106
7.7.2.4	Offset 08h: RID - Revision Identification.....	106
7.7.2.5	Offset 09h: CC - Class Codes.....	106
7.7.2.6	Offset 0Eh: HDR - Header Type.....	107
7.7.2.7	Offset 10h: MMADR - Memory Mapped Base Address.....	107



- 7.7.2.8 Offset 14h: IOBAR - I/O Base Address 108
- 7.7.2.9 Offset 2Ch: SS - Subsystem Identifiers 108
- 7.7.2.10 Offset 34h: CAP_PTR - Capabilities Pointer..... 108
- 7.7.2.11 Offset 3Ch: INTR - Interrupt Information..... 108
- 7.7.2.12 Offset 58h: SSRW - Software Scratch Read Write 109
- 7.7.2.13 Offset 60h: HSRW - Hardware Scratch Read Write 109
- 7.7.2.14 Offset 90h: MID - Message Signaled Interrupts Capability 109
- 7.7.2.15 Offset 92h: MC - Message Control 109
- 7.7.2.16 Offset 94h: MA - Message Address..... 110
- 7.7.2.17 Offset 98h: MD - Message Data 110
- 7.7.2.18 Offset C4h: FD - Functional Disable 110
- 7.7.2.19 Offset E0h: SWSCISMI - Software SCI/SMI 111
- 7.7.2.20 Offset E4h: ASLE - System Display Event Register 111
- 7.7.2.21 Offset F0h: GCR - Graphics Clock Ratio 111
- 7.7.2.22 Offset F4h: LBB - Legacy Backlight Brightness..... 112
- 8.0 PCI Express*** 113
 - 8.1 Functional Description 113
 - 8.1.1 Interrupt Generation 113
 - 8.1.2 Power Management..... 113
 - 8.1.2.1 Sleep State Support 113
 - 8.1.2.2 Resuming from Suspended State 113
 - 8.1.2.3 Device Initiated PM_PME Message 113
 - 8.1.2.4 SMI/SCI Generation..... 114
 - 8.1.3 Additional Clarifications 114
 - 8.1.3.1 Non-Snoop Cycles Are Not Supported 114
 - 8.2 PCI Express* Configuration Registers 114
 - 8.2.1 PCI Type 1 Bridge Header 114
 - 8.2.1.1 VID — Vendor Identification..... 115
 - 8.2.1.2 DID — Device Identification 115
 - 8.2.1.3 CMD — PCI Command..... 116
 - 8.2.1.4 PSTS — Primary Status 116
 - 8.2.1.5 RID — Revision Identification 117
 - 8.2.1.6 CC — Class Code..... 117
 - 8.2.1.7 CLS — Cache Line Size..... 118
 - 8.2.1.8 HTYPE — Header Type 118
 - 8.2.1.9 PBN — Primary Bus Number 118
 - 8.2.1.10 SCBN — Secondary Bus Number 118
 - 8.2.1.11 SBBN — Subordinate Bus Number 119
 - 8.2.1.12 IOBASE — I/O Base Address 119
 - 8.2.1.13 IOLIMIT — I/O Limit Address 120
 - 8.2.1.14 SSTS — Secondary Status 120
 - 8.2.1.15 MB — Memory Base Address 121
 - 8.2.1.16 ML — Memory Limit Address 121
 - 8.2.1.17 PMB — Prefetchable Memory Base Address 121
 - 8.2.1.18 PML — Prefetchable Memory Limit Address 122
 - 8.2.1.19 CAPP — Capabilities Pointer 122
 - 8.2.1.20 ILINE — Interrupt Line 122
 - 8.2.1.21 IPIN — Interrupt Pin 123
 - 8.2.1.22 BCTRL — Bridge Control..... 123
 - 8.2.2 Root Port Capability Structure 124
 - 8.2.2.1 CLIST — Capabilities List 125
 - 8.2.2.2 XCAP — PCI Express* Capabilities 125
 - 8.2.2.3 DCAP — Device Capabilities 125
 - 8.2.2.4 DCTL — Device Control 126
 - 8.2.2.5 DSTS — Device Status 127
 - 8.2.2.6 LCAP — Link Capabilities 127
 - 8.2.2.7 LCTL — Link Control 128
 - 8.2.2.8 LSTS — Link Status 128



8.2.2.9	SLCAP — Slot Capabilities	129
8.2.2.10	SLCTL — Slot Control	129
8.2.2.11	SLSTS — Slot Status	130
8.2.2.12	RCTL — Root Control	131
8.2.2.13	RCAP — Root Capabilities	131
8.2.2.14	RSTS — Root Status	131
8.2.3	PCI Bridge Vendor Capability	132
8.2.3.1	SVCAP — Subsystem Vendor Capability	132
8.2.3.2	SVID — Subsystem Vendor IDs	132
8.2.4	PCI Power Management Capability	132
8.2.4.1	PMCAP — Power Management Capability ID	133
8.2.4.2	PMC — PCI Power Management Capabilities	133
8.2.4.3	PMCS — PCI Power Management Control And Status	133
8.2.5	Port Configuration	134
8.2.5.1	MPC — Miscellaneous Port Configuration	135
8.2.5.2	SMSCS — SMI / SCI Status	136
8.2.6	Miscellaneous Configuration	137
8.2.6.1	FD — Functional Disable	137
9.0	Intel® High Definition Audio^β D27:F0	139
9.1	Overview	139
9.2	Docking	139
9.2.1	Dock Sequence	140
9.2.2	Undock Sequence	141
9.2.3	Relationship Between HDA_DOCKRST_B and HDA_RST_B	141
9.2.4	External Pull-Ups/Pull-Downs	142
9.3	PCI Configuration Register Space	142
9.3.1	Registers	142
9.3.1.1	Offset 00h: VID — Vendor Identification	144
9.3.1.2	Offset 02h: DID — Device Identification	144
9.3.1.3	Offset 04h: PCICMD — PCI Command Register	144
9.3.1.4	Offset 06h: PCISTS — PCI Status Register	145
9.3.1.5	Offset 08h: RID — Revision Identification Register	145
9.3.1.6	Offset 09h: CC — Class Codes Register	146
9.3.1.7	Offset 0Ch: CLS - Cache Line Size Register	146
9.3.1.8	Offset 0Dh: LT — Latency Timer Register	146
9.3.1.9	Offset 0Eh: HEADTYP - Header Type Register	147
9.3.1.10	Offset 10h: LBAR — Lower Base Address Register	147
9.3.1.11	Offset 14h: UBAR — Upper Base Address Register	147
9.3.1.12	Offset 2Ch: SVID—Subsystem Vendor Identifier	147
9.3.1.13	Offset 2Eh: SID—Subsystem Identifier	148
9.3.1.14	Offset 34h — CAP_PTR — Capabilities Pointer Register	148
9.3.1.15	Offset 3Ch — INTLN: Interrupt Line Register	149
9.3.1.16	Offset 3Dh — INTPN—Interrupt Pin Register	149
9.3.1.17	Offset 40h — HDCTL— Intel® High Definition Audio ^β Control Register	149
9.3.1.18	Offset 4Ch — DCKCTL—Docking Control Register	150
9.3.1.19	Offset 4Dh — DCKSTS—Docking Status Register	150
9.3.1.20	Offset 50h: PM_CAPID - PCI Power Management Capability ID Register	151
9.3.1.21	Offset 52h: PM_CAP — Power Management Capabilities Register	151
9.3.1.22	Offset 54h: PM_CTL_STS - Power Management Control And Status Register	151
9.3.1.23	Offset 60h: MSI_CAPID - MSI Capability ID Register	152
9.3.1.24	Offset 62h: MSI_CTL - MSI Message Control Register	152
9.3.1.25	Offset 64h: MSI_ADR - MSI Message Address Register	153
9.3.1.26	Offset 68h: MSI_DATA - MSI Message Data Register	153
9.3.1.27	Offset 70h: PCIE_CAPID — PCI Express* Capability Identifiers Register	153



- 9.3.1.28 Offset 72h: PCIECAP – PCI Express* Capabilities Register 153
- 9.3.1.29 Offset 74h: DEVCAP – Device Capabilities Register 154
- 9.3.1.30 Offset 78h: DEVC – Device Control 154
- 9.3.1.31 Offset 7Ah: DEVS – Device Status Register 155
- 9.3.1.32 Offset FCh – FD: Function Disable Register 155
- 9.3.1.33 Offset 100h: VCCAP – Virtual Channel Enhanced Capability Header 155
- 9.3.1.34 Offset 104h: PVCCAP1 – Port VC Capability Register 1 156
- 9.3.1.35 Offset 108h: PVCCAP2 – Port VC Capability Register 2 156
- 9.3.1.36 Offset 10Ch: PVCCTL – Port VC Control Register 156
- 9.3.1.37 Offset 10Eh: PVCSTS – Port VC Status Register 156
- 9.3.1.38 Offset 110h: VCOCAP – VC0 Resource Capability Register 157
- 9.3.1.39 Offset 114h: VCOCTL – VC0 Resource Control Register 157
- 9.3.1.40 Offset 11Ah: VCOSTS – VC0 Resource Status Register 157
- 9.3.1.41 Offset 11Ch: VC1CAP – VC1 Resource Capability Register 157
- 9.3.1.42 Offset 120h: VC1CTL – VC1 Resource Control Register 158
- 9.3.1.43 Offset 126h: VC1STS – VC1 Resource Status Register 158
- 9.3.1.44 Offset 130h: RCCAP – Root Complex Link Declaration Enhanced
Capability Header Register 158
- 9.3.1.45 Offset 134h: ESD – Element Self Description Register 159
- 9.3.1.46 Offset 140h: L1DESC – Link 1 Description Register 159
- 9.3.1.47 Offset 148h: L1ADD – Link 1 Address Register 159
- 9.3.2 Memory Mapped Configuration Registers 160
 - 9.3.2.1 Intel® HD Audio^β Registers 160
- 10.0 LPC Interface (D31:F0) 191**
 - 10.1 Functional Overview 191
 - 10.1.1 Memory Cycle Notes 191
 - 10.1.2 Intel® Trusted Platform Module^ε 1.2 Support 191
 - 10.1.3 FWH Cycle Notes 191
 - 10.1.4 LPC Output Clocks 191
 - 10.2 PCI Configuration Registers 192
 - 10.2.1 ID—Identifiers 192
 - 10.2.2 CMD—Device Command Register 193
 - 10.2.3 STS—Device Status Register 193
 - 10.2.4 RID—Revision ID Register 193
 - 10.2.5 CC—Class Code Register 194
 - 10.2.6 HDTYPE—Header Type Register 194
 - 10.2.7 SS—Subsystem Identifiers Register 194
 - 10.3 ACPI Device Configuration 195
 - 10.3.1 SMBA—SMBus Base Address Register 195
 - 10.3.2 GBA—GPIO Base Address Register 195
 - 10.3.3 PM1BLK—PM1_BLK Base Address Register 195
 - 10.3.4 GPEOBLK—GPE0_BLK Base Address Register 196
 - 10.3.5 LPCS—LPC Clock Strength Control Register 196
 - 10.3.6 ACTL—ACPI Control Register 197
 - 10.3.7 MC - Miscellaneous Control Register 197
 - 10.4 Interrupt Control 199
 - 10.4.1 PxRC—PIRQx Routing Control Register 199
 - 10.4.2 SCNT—Serial IRQ Control Register 200
 - 10.4.3 WDTBA-WDT Base Address 200
 - 10.5 FWH Configuration Registers 200
 - 10.5.1 FS—FWH ID Select Register 200
 - 10.5.2 BDE—BIOS Decode Enable 201
 - 10.5.3 BC—BIOS Control Register 202
 - 10.6 Root Complex Register Block Configuration 203
 - 10.6.1 RCBA—Root Complex Base Address Register 203



11.0 ACPI Devices	205
11.1 8254 Timer	205
11.1.1 Counter 0, System Timer	205
11.1.2 Counter 1, Refresh Request Signal.....	205
11.1.3 Counter 2, Speaker Tone.....	205
11.1.4 Timer I/O Registers	205
11.1.5 Offset 43h: TCW - Timer Control Word Register	205
11.1.5.1 Read Back Command	206
11.1.5.2 Counter Latch Command.....	207
11.1.5.3 Offset 40h, 41h, 42h: Interval Timer Status Byte Format Register .	207
11.1.5.4 Offset 40h, 41h, 42h: Counter Access Ports Register	208
11.1.6 Timer Programming.....	208
11.1.7 Reading from the Interval Timer.....	209
11.1.7.1 Simple Read.....	209
11.1.7.2 Counter Latch Command.....	209
11.1.7.3 Read Back Command	210
11.2 High Precision Event Timer	210
11.2.1 Registers.....	210
11.2.1.1 Offset 000h: GCID – General Capabilities and ID.....	211
11.2.1.2 Offset 010h: GC – General Configuration	211
11.2.1.3 Offset 020h: GIS – General Interrupt Status.....	212
11.2.1.4 Offset 0F0h: MCV – Main Counter Value.....	212
11.2.1.5 Offset 100h, 120h, 140h: T[0-2]C – Timer [0-2] Config and Capabilities	212
11.2.1.6 Offset 108h, 128h, 148h: T[0-2]CV – Timer [0-2] Comparator Value	213
11.2.2 Theory Of Operation	214
11.2.2.1 Non-Periodic Mode – All timers	214
11.2.2.2 Periodic Mode – Timer 0 only.....	215
11.2.2.3 Interrupts.....	215
11.2.2.4 Mapping Option #2: Standard Option (GC.LRE cleared).....	216
11.3 8259 Interrupt Controller	216
11.3.1 Overview	216
11.3.2 I/O Registers	217
11.3.2.1 Offset 20h, A0h: ICW1 – Initialization Command Word 1.....	217
11.3.2.2 Offset 21h, A1h: ICW2 – Initialization Command Word 2.....	218
11.3.2.3 Offset 21h: MICW3 – Master Initialization Command Word 3	219
11.3.2.4 Offset A1h: SICW3 – Slave Initialization Command Word 3.....	219
11.3.2.5 Offset 21h, A1h: ICW4 – Initialization Command Word 4 Register .	219
11.3.2.6 Offset 21h, A1h: OCW1 – Operational Control Word 1 (Interrupt Mask).....	220
11.3.2.7 Offset 20h, A0h: OCW2 – Operational Control Word 2.....	220
11.3.2.8 Offset 4D0h: ELCR1 – Master Edge/Level Control	221
11.3.2.9 Offset 4D1h: ELCR2 – Slave Edge/Level Control.....	222
11.3.3 Interrupt Handling.....	222
11.3.3.1 Generating.....	222
11.3.3.2 Acknowledging	222
11.3.3.3 Hardware/Software Interrupt Sequence	223
11.3.4 Initialization Command Words (ICW)	223
11.3.4.1 ICW1	223
11.3.4.2 ICW2	224
11.3.4.3 ICW3	224
11.3.4.4 ICW4	224
11.3.5 Operation Command Words (OCW).....	224
11.3.6 Modes of Operation	224
11.3.6.1 Fully Nested Mode.....	224
11.3.6.2 Special Fully Nested Mode.....	225

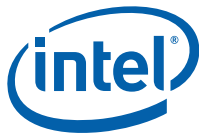

- 11.3.6.3 Automatic Rotation Mode (Equal Priority Devices) 225
- 11.3.6.4 Specific Rotation Mode (Specific Priority) 225
- 11.3.6.5 Poll Mode 225
- 11.3.6.6 Edge and Level Triggered Mode 226
- 11.3.7 End Of Interrupt (EOI) 226
 - 11.3.7.1 Normal EOI 226
 - 11.3.7.2 Automatic EOI 226
- 11.3.8 Masking Interrupts 226
 - 11.3.8.1 Masking on an Individual Interrupt Request 226
 - 11.3.8.2 Special Mask Mode 226
- 11.3.9 Steering of PCI Interrupts 227
- 11.4 Advanced Peripheral Interrupt Controller (APIC) 227
 - 11.4.1 Memory Registers 227
 - 11.4.1.1 Address FEC00000h: IDX – Index Register 227
 - 11.4.1.2 Address FEC00010h: WDW – Window Register 227
 - 11.4.1.3 Address FEC00040h: EOI – EOI Register 227
 - 11.4.2 Index Registers 228
 - 11.4.2.1 Offset 00h: ID – Identification Register 228
 - 11.4.2.2 Offset 01h: VS – Version Register 228
 - 11.4.2.3 Offset 10-11h – 3E-3Fh: RTE[0-23] – Redirection Table Entry 229
 - 11.4.3 Unsupported Modes 230
 - 11.4.4 Interrupt Delivery 230
 - 11.4.4.1 Theory of Operation 230
 - 11.4.4.2 EOI 230
 - 11.4.4.3 Interrupt Message Format 230
 - 11.4.4.4 Interrupt Delivery Address Value 230
 - 11.4.4.5 Interrupt Delivery Data Value 231
 - 11.4.5 PCI Express* Interrupts 231
 - 11.4.6 Routing of Internal Device Interrupts 231
- 11.5 Serial Interrupt 231
 - 11.5.1 Overview 231
 - 11.5.2 Start Frame 232
 - 11.5.3 Data Frames 232
 - 11.5.4 Stop Frame 232
 - 11.5.5 Serial Interrupts Not Supported 233
 - 11.5.6 Data Frame Format and Issues 233
- 11.6 Real Time Clock 234
 - 11.6.1 Overview 234
 - 11.6.2 I/O Registers 234
 - 11.6.3 Indexed Registers 234
 - 11.6.3.1 Offset 0Ah: Register A 235
 - 11.6.3.2 Offset 0Bh: Register B - General Configuration 236
 - 11.6.3.3 Offset 0Ch: Register C - Flag Register (RTC Well) 236
 - 11.6.3.4 Offset 0Dh: Register D - Flag Register (RTC Well) 237
 - 11.6.4 Update Cycles 237
 - 11.6.5 Interrupts 237
- 11.7 General Purpose I/O 238
 - 11.7.1 Core Well GPIO I/O Registers 238
 - 11.7.1.1 Offset 00h: CGEN – Core Well GPIO Enable 238
 - 11.7.1.2 Offset 04h: CGIO – Core Well GPIO Input/Output Select 239
 - 11.7.1.3 Offset 08h: CGLVL – Core Well GPIO Level for Input or Output 239
 - 11.7.1.4 Offset 0Ch: CGTPE – Core Well GPIO Trigger Positive Edge Enable 239
 - 11.7.1.5 Offset 10h: CGTNE – Core Well GPIO Trigger Negative Edge Enable 240
 - 11.7.1.6 Offset 14h: CGGPE – Core Well GPIO GPE Enable 240
 - 11.7.1.7 Offset 18h: CGSMI – Core Well GPIO SMI Enable 240
 - 11.7.1.8 Offset 1Ch: CGTS – Core Well GPIO Trigger Status 241
 - 11.7.2 Resume Well GPIO I/O Registers 241



11.7.2.1	Offset 20h: RGEN – Resume Well GPIO Enable.....	241
11.7.2.2	Offset 24h: RGIO – Resume Well GPIO Input/Output Select.....	242
11.7.2.3	Offset 28h: RGLVL – Resume Well GPIO Level for Input or Output .	242
11.7.2.4	Offset 2Ch: RGTPPE – Resume Well GPIO Trigger Positive Edge Enable.....	243
11.7.2.5	Offset 30h: RGTNE – Resume Well GPIO Trigger Negative Edge Enable.....	243
11.7.2.6	Offset 34h: RGGPE – Resume Well GPIO GPE Enable	243
11.7.2.7	Offset 38h: RGSMI – Resume Well GPIO SMI Enable.....	244
11.7.2.8	Offset 3Ch: RGTS – Resume Well GPIO Trigger Status	244
11.7.3	Theory of Operation.....	244
11.7.3.1	Power Wells	244
11.7.3.2	SMI# and SCI Routing.....	244
11.7.3.3	Triggering.....	244
11.8	SMBus Controller.....	245
11.8.1	Overview	245
11.8.2	I/O Registers	245
11.8.2.1	Offset 00h: HCTL - Host Control Register	245
11.8.2.2	Offset 01h: HSTS - Host Status Register	246
11.8.2.3	Offset 02h: HCLK – Host Clock Divider.....	247
11.8.2.4	Offset 04h: TSA - Transmit Slave Address.....	247
11.8.2.5	Offset 05h: HCMD - Host Command Register	247
11.8.2.6	Offset 06h: HD0 - Host Data 0.....	248
11.8.2.7	Offset 07h: HD1 - Host Data 1.....	248
11.8.2.8	Offset 20h – 3Fh: HBD – Host Block Data.....	248
11.8.3	Overview	248
11.8.4	Bus Arbitration.....	249
11.8.5	Bus Timings.....	249
11.8.5.1	Clock Stretching	249
11.8.5.2	Bus Time Out	250
11.8.6	SMI#.....	250
11.9	Serial Peripheral Interface	250
11.9.1	Overview	250
11.9.2	Features	250
11.9.3	External Interface	250
11.9.4	SPI Protocol.....	251
11.9.4.1	SPI Pin Level Protocol.....	251
11.9.5	Host Side Interface.....	253
11.9.5.1	SPI Host Interface Registers.....	253
11.9.5.2	Offset 00h: SPIS – SPI Status	254
11.9.5.3	Offset 02h: SPIC – SPI Control	255
11.9.5.4	Offset 04h: SPIA – SPI Address	256
11.9.5.5	Offset 08h: SPID0 – SPI Data 0	256
11.9.5.6	Offset 10h, 18h, 20h, 28h, 30h, 38h, 40h: SPID[0-6] – SPI Data N.....	257
11.9.5.7	Offset 50h: BBAR – BIOS Base Address	257
11.9.5.8	Offset 54h: PREOP – Prefix Opcode Configuration.....	257
11.9.5.9	Offset 56h: OPTYPE – Opcode Type Configuration	258
11.9.5.10	Offset 58h: OPMENU – Opcode Menu Configuration	258
11.9.5.11	Offset 60h: PBRO – Protected BIOS Range [0-2]	259
11.9.5.12	Running SPI Cycles from the Host.....	260
11.9.5.13	Generic Programmed Commands	262
11.9.5.14	Flash Protection.....	262
11.9.6	SPI Clocking	264
11.9.7	BIOS Programming Considerations	264
11.9.7.1	Run Time Updates.....	265
11.9.7.2	BIOS Sector Updates.....	265
11.9.7.3	SPI Initialization	266
11.10	Watchdog Timer.....	267

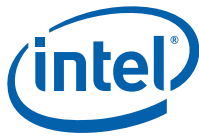

- 11.10.1 Overview 267
- 11.10.2 Features 267
- 11.10.3 Watchdog Timer Register Details 267
 - 11.10.3.1 Offset 00h: PV1R0 - Preload Value 1 Register 0 268
 - 11.10.3.2 Offset 01h: PV1R1 - Preload Value 1 Register 1 269
 - 11.10.3.3 Offset 02h: PV1R2 - Preload Value 1 Register 2 269
 - 11.10.3.4 Offset 04h: PV2R0 - Preload Value 2 Register 0 270
 - 11.10.3.5 Offset 05h: PV2R1 - Preload Value 2 Register 1 270
 - 11.10.3.6 Offset 06h: PV2R2 - Preload Value 2 Register 2 270
 - 11.10.3.7 Offset 0Ch: RR0 - Reload Register 0 271
 - 11.10.3.8 Offset 0Dh: RR1 - Reload Register 1 271
 - 11.10.3.9 Offset 10h: WDTCR - WDT Configuration Register 272
 - 11.10.3.10 Offset 14h: DCR0 - Down Counter Register 0 272
 - 11.10.3.11 Offset 15h: DCR1 - Down Counter Register 1 273
 - 11.10.3.12 Offset 16h: DCR2 - Down Counter Register 2 273
 - 11.10.3.13 Offset 18h: WDTLR - WDT Lock Register 273
- 11.10.4 Theory Of Operation 274
 - 11.10.4.1 RTC Well and WDT_TOUT Functionality 274
 - 11.10.4.2 Register Unlocking Sequence 274
 - 11.10.4.3 Reload Sequence 275
 - 11.10.4.4 Low Power State 275
- 12.0 Absolute Maximum Ratings 277**
 - 12.1 Absolute Maximum Rating 278
- 13.0 DC Characteristics 279**
 - 13.1 Signal Groups 279
 - 13.2 Power and Current Characteristics 280
 - 13.3 General DC Characteristics 281
- 14.0 Ballout and Package Information 285**
 - 14.1 Package Diagrams 286
 - 14.2 Ballout Definition and Signal Locations 288

Figures

- 1 System Block Diagram Example 23
- 2 Components of the Intel® Atom™ Processor E6xx Series 26
- 3 System Address Map 57
- 4 PCI Devices 60
- 5 Graphics Unit 77
- 6 Display Link Interface 86
- 7 Display Resolutions 89
- 8 LVDS Control Signal Solution 90
- 9 Basic SPI Protocol 251
- 10 Intel® Atom™ Processor E6xx Series Silicon and Die Side Capacitor (Top View) 286
- 11 Intel® Atom™ Processor E6xx Series Package Dimensions 287
- 12 Intel® Atom™ Processor E6xx Series Package Ball Pattern 288
- 13 Intel® Atom™ Processor E6xx Series Ball Map (Sheet 1 of 5) 289
- 14 Intel® Atom™ Processor E6xx Series Ball Map (Sheet 2 of 5) 290
- 15 Intel® Atom™ Processor E6xx Series Ball Map (Sheet 3 of 5) 291
- 16 Intel® Atom™ Processor E6xx Series Ball Map (Sheet 4 of 5) 292
- 17 Intel® Atom™ Processor E6xx Series Ball Map (Sheet 5 of 5) 293

Tables

- 1 PCI Devices and Functions 25

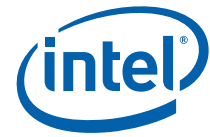

2	Intel® Atom™ Processor E6xx Series SKU for Different Segments.....	30
3	Buffer Types.....	31
4	System Memory Signals.....	32
5	LVDS Signals.....	33
6	Serial Digital Video Output Signals	34
7	PCI Express* Signals.....	35
8	Intel® High Definition Audio ^β Interface Signals.....	35
9	LPC Interface Signals.....	36
10	SMBus Interface Signals	36
11	SPI Interface Signals.....	36
12	Power Management Interface Signals.....	37
13	Real Time Clock Interface Signals.....	38
14	JTAG and Debug Interface Signals.....	39
15	Miscellaneous Signals and Clocks	40
16	General Purpose I/O Signals.....	43
17	Functional Straps	43
18	Power and Ground Signals.....	44
19	Reset State Definitions	47
20	System Memory Signals.....	47
21	LVDS Signals.....	48
22	Serial Digital Video Output Signals	48
23	PCI Express* Signals.....	49
24	Intel® High Definition Audio ^β Interface Signals.....	49
25	LPC Interface Signals.....	50
26	SMBus Interface Signals	50
27	SPI Interface Signals.....	50
28	Power Management Interface Signals.....	50
29	Real Time Clock Interface Signals.....	51
30	JTAG and Debug Interface Signals.....	51
31	Miscellaneous Signals and Clocks	51
32	General Purpose I/O Signals.....	52
33	Integrated Termination Resistors	52
34	Intel® Atom™ Processor E6xx Series Clock Domains.....	53
35	Register Access Types and Definitions.....	55
36	Memory Map	57
37	Fixed I/O Range Decoded by the Processor.....	58
38	Variable I/O Range Decoded by the Processor.....	59
39	PCI Devices and Functions.....	59
40	PCI Configuration PORT CF8h Mapping.....	61
41	PCI Configuration Memory Bar Mapping	62
42	PCI Express* Capability List Structure.....	62
43	0000h: RCTCL – Root Complex Topology Capabilities List	62
44	0004h: ESD – Element Self Description.....	63
45	0010h: HDD – Intel® High Definition Audio ^β Description.....	63
46	0018h: HDBA – Intel® High Definition Audio ^β Base Address	63
47	Interrupt Pin Configuration.....	64
48	3100h: D31IP – Device 31 Interrupt Pin.....	64
49	3110h: D27IP – Device 27 Interrupt Pin.....	64
50	3118h: D02IP – Device 2 Interrupt Pin	65
51	3120h: D26IP – Device 26 Interrupt Pin.....	65
52	3124h: D25IP – Device 25 Interrupt Pin.....	65
53	3128h: D24IP – Device 24 Interrupt Pin.....	65
54	312Ch: D23IP – Device 23 Interrupt Pin.....	66
55	3130h: D03IP – Device 3 Interrupt Pin	66
56	Interrupt Route Configuration.....	66



57	3140h: D31IR – Device 31 Interrupt Route	66
58	3148h: D27IR – Device 27 Interrupt Route	67
59	314Ah: D26IR – Device 26 Interrupt Route	67
60	314Ch: D25IR – Device 25 Interrupt Route	68
61	314Eh: D24IR – Device 24 Interrupt Route	68
62	3150h: D23IR – Device 23 Interrupt Route	68
63	3160h: D02IR – Device 2 Interrupt Route	69
64	3162h: D03IR – Device 3 Interrupt Route	69
65	3400h: RC – RTC Configuration	69
66	3410h: BNT– Boot Configuration	70
67	Memory Controller Supported Frequencies and Data Rates	71
68	Supported Memory Configurations for DDR2	73
69	Supported DDR2 DRAM Devices	74
70	Memory Size Per Rank	74
71	DRAM Address Decoder	75
72	Encode Profiles and Levels of Support	82
73	Hardware Accelerated Video Decoding Support	83
74	Pixel Format for the Luma (Y) Plane	85
75	Pixel Formats for the Cr/Cb (V/U) Plane	85
76	PCI Header for D2	92
77	00h: GVD.ID – D2: PCI Device and Vendor ID Register	93
78	04h: GVD.PCICMDSTS – PCI Command and Status Register	93
79	08h: GVD.RIDCC - Revision Identification and Class Code	94
80	0Ch: GVD.HDR – Header Type	94
81	10h: GVD.MMADR – Memory Mapped Address Range	95
82	14h: GVD.GFX_IOBAR – I/O Base Address	95
83	18h: GVD.GMADR – Graphics Memory Address Range	96
84	1Ch: GVD.GTTADR – Graphics Translation Table Address Range	96
85	2Ch: GVD.SSID – Subsystem Identifiers	97
86	34h: GVD.CAPPOINT – Capabilities Pointer	97
87	3Ch: GVD.INTR – Interrupt	97
88	50h: GVD.MGGC – Graphics Control	98
89	5Ch: GVD.BSM – Base of Stolen Memory	99
90	60h: GVD.MSAC – Multi Size Aperture Control	99
91	90h: GVD.MSI_CAPID – Message Signaled Interrupts Capability ID and Control Register	99
92	94h: GVD.MA – Message Address	100
93	98h: GVD.MD – Message Data	100
94	B0h: GVD.VCID – Vendor Capability ID	101
95	B4h: GVD.VC – Vendor Capabilities	101
96	C4h: GVD.FD – Functional Disable	101
97	D0h: GVD.PMCAP – Power Management Capabilities	102
98	D4h: GVD.PMCS – Power Management Control/Status	102
99	E0h: GVD.SWSMISCI – Software SMI or SCI	102
100	E4h: GVD.ASLE – System Display Event Register	103
101	F4h: GVD.LBB – Legacy Backlight Brightness	103
102	FCh: GVD.ASLS ASL – ASL Storage	104
103	PCI Header	104
104	Offset 00h: ID – Identifiers	105
105	Offset 04h: CMD – PCI Command	105
106	Offset 06h: STS - PCI Status	106
107	Offset 08h: RID - Revision Identification	106
108	Offset 09h: CC - Class Codes	106
109	Offset 0Eh: HDR - Header Type	107
110	Offset 10h: MMADR - Memory Mapped Base Address	107
111	Offset 14h: IOBAR - I/O Base Address	108



112	Offset 34h: CAP_PTR - Capabilities Pointer	108
113	Offset 3Ch: INTR - Interrupt Information	108
114	Offset 58h: SSRW - Software Scratch Read Write	109
115	Offset 60h: HSRW - Hardware Scratch Read Write	109
116	Offset 90h: MID - Message Signaled Interrupts Capability	109
117	Offset 92h: MC - Message Control	109
118	Offset 94h: MA - Message Address	110
119	Offset 98h: MD - Message Data	110
120	Offset C4h: FD - Functional Disable	110
121	Offset E0h: SWSCISMI - Software SCI/SMI	111
122	Offset E4h: ASLE - System Display Event Register	111
123	Offset F0h: GCR - Graphics Clock Ratio	111
124	Offset F4h: LBB - Legacy Backlight Brightness	112
125	MSI vs. PCI IRQ Actions	113
126	PCI Type 1 Bridge Header	114
127	Offset 00h: VID — Vendor Identification	115
128	Offset 02h: DID — Device Identification	116
129	Offset 04h: CMD — PCI Command	116
130	Offset 06h: PSTS — Primary Status	117
131	Offset 08h: RID — Revision Identification	117
132	Offset 09h: CC — Class Code	117
133	Offset 0Ch: CLS — Cache Line Size	118
134	Offset 0Eh: HTYPE — Header Type	118
135	Offset 18h: PBN — Primary Bus Number	118
136	Offset 19h: SCBN — Secondary Bus Number	119
137	Offset 1Ah: SBBN — Subordinate Bus Number	119
138	Offset 1Ch: IOBASE — I/O Base Address	119
139	Offset 1Dh: IOLIMIT — I/O Limit Address	120
140	Offset 1Eh: SSTS — Secondary Status	120
141	Offset 20h: MB — Memory Base Address	121
142	Offset 22h: ML — Memory Limit Address	121
143	Offset 24h: PMB — Prefetchable Memory Base Address	122
144	Offset 26h: PML — Prefetchable Memory Limit Address	122
145	Offset 34h: CAPP — Capabilities Pointer	122
146	Offset 3Ch: ILINE — Interrupt Line	123
147	Offset 3Dh: IPIN — Interrupt Pin	123
148	Offset 3Eh: BCTRL — Bridge Control	123
149	Root Port Capability Structure	124
150	Offset 40h: CLIST — Capabilities List	125
151	Offset 42h: XCAP — PCI Express* Capabilities	125
152	Offset 44h: DCAP — Device Capabilities	125
153	Offset 48h: DCTL — Device Control	126
154	Offset 4Ah: DSTS — Device Status	127
155	Offset 4Ch: LCAP — Link Capabilities	127
156	Offset 50h: LCTL — Link Control	128
157	Offset 52h: LSTS — Link Status	128
158	Offset 54h: SLCAP — Slot Capabilities	129
159	Offset 58h: SLCTL — Slot Control	129
160	Offset 5Ah: SLSTS — Slot Status	130
161	Offset 5Ch: RCTL — Root Control	131
162	Offset 5Eh: RCAP — Root Capabilities	131
163	Offset 60h: RSTS — Root Status	131
164	PCI Bridge Vendor Capability	132
165	Offset 90h: SVCAP — Subsystem Vendor Capability	132
166	Offset 94h: SVID — Subsystem Vendor IDs	132



167 PCI Power Management Capability 132

168 Offset A0h: PMCAP — Power Management Capability ID..... 133

169 Offset A2h: PMC — PCI Power Management Capabilities 133

170 Offset A4h: PMCS — PCI Power Management Control And Status 133

171 Port Configuration 134

172 Offset D8h: MPC — Miscellaneous Port Configuration 135

173 Offset DCh: SMSCS — SMI / SCI Status 136

174 Miscellaneous Configuration 137

175 Offset FCh: FD — Functional Disable 137

176 External Resistors..... 142

177 Intel® High Definition Audio^β PCI Configuration Registers..... 142

178 00h: VID – Vendor Identification 144

179 02h: DID – Device Identification..... 144

180 04h: PCICMD – PCI Command Register 144

181 06h: PCISTS – PCI Status Register 145

182 08h: RID – Revision Identification Register 145

183 09h: CC – Class Codes Register..... 146

184 0Ch: CLS - Cache Line Size Register 146

185 0Dh: LT – Latency Timer Register..... 146

186 0Eh: HEADTYP - Header Type Register 147

187 10h: LBAR – Lower Base Address Register 147

188 14h: UBAR – Upper Base Address Register..... 147

189 2Ch: SVID—Subsystem Vendor Identifier..... 148

190 2Eh: SID—Subsystem Identifier 148

191 34h – CAP_PTR – Capabilities Pointer Register..... 148

192 3Ch – INTLN: Interrupt Line Register 149

193 3Dh – INTPN — Interrupt Pin Register 149

194 40h – HDCTL— Intel® High Definition Audio^β Control Register 149

195 4Ch – DCKCTL — Docking Control Register 150

196 4Dh: DCKSTS – Docking Status Register 150

197 50h: PM_CAPID – PCI Power Management Capability ID Register 151

198 52h: PM_CAP – Power Management Capabilities Register 151

199 54h: PM_CTL_STS - Power Management Control And Status Register 151

200 60h: MSI_CAPID - MSI Capability ID Register..... 152

201 62h: MSI_CTL - MSI Message Control Register 152

202 64h: MSI_ADR - MSI Message Address Register 153

203 68h: MSI_DATA - MSI Message Data Register 153

204 70h: PCIE_CAPID – PCI Express* Capability Identifiers Register 153

205 72h: PCIECAP – PCI Express* Capabilities Register 153

206 74h: DEVCAP – Device Capabilities Register 154

207 78h: DEVC – Device Control..... 154

208 7Ah: DEVS – Device Status Register 155

209 FCh – FD: Function Disable Register..... 155

210 100h: VCCAP – Virtual Channel Enhanced Capability Header 155

211 104h: PVCCAP1 – Port VC Capability Register 1 156

212 108h: PVCCAP2 – Port VC Capability Register 2 156

213 10Ch: PVCCTL – Port VC Control Register 156

214 10Eh: PVCSTS – Port VC Status Register 156

215 110h: VCOCAP – VC0 Resource Capability Register..... 157

216 114h: VCOCTL – VC0 Resource Control Register..... 157

217 11Ah: VC0STS – VC0 Resource Status Register 157

218 11Ch: VC1CAP – VC1 Resource Capability Register 157

219 120h: VC1CTL – VC1 Resource Control Register..... 158

220 126h: VC1STS – VC1 Resource Status Register 158

221 130h: RCCAP – Root Complex Link Declaration Enhanced Capability Header Register 158



222	134h: ESD – Element Self Description Register	159
223	140h: L1DESC – Link 1 Description Register	159
224	148h: L1ADD – Link 1 Address Register	159
225	Intel® HD Audio ^β Register Summary	160
226	00h: GCAP – Global Capabilities Register	162
227	02h: VMIN – Minor Version Register	163
228	03h: VMAJ – Major Version	163
229	04h: OUTPAY – Output Payload Capability Register	163
230	06h: INPAY – Input Payload Capability Register	164
231	08h: GCTL – Global Control	164
232	0Ch: WAKEEN – Wake Enable	165
233	0Eh: STATESTS – State Change Status	166
234	10h: GSTS – Global Status	166
235	14h: ECAP - Extended Capabilities	167
236	18h: STRMPAY – Stream Payload Capability Register	167
237	20h: INTCTL - Interrupt Control Register	168
238	24h: INTSTS - Interrupt Status Register	168
239	30h: WALCLK – Wall Clock Counter Register	169
240	38h: SSYNC –Stream Synchronization Register	169
241	40h: CORBBASE - CORB Base Address Register	170
242	48h: CORBWP - CORB Write Pointer Register	170
243	4Ah: CORBRP - CORB Read Pointer Register	171
244	4Ch: CORBCTL - CORB Control Register	171
245	4Dh: CORBSTS - CORB Status Register	172
246	4Eh: CORBSIZE - CORB Size Register	172
247	50h: RIRBBASE - RIRB Base Address Register	173
248	58h: RIRBWP - RIRB Write Pointer Register	173
249	5Ah: RINTCNT – Response Interrupt Count Register	173
250	5Ch: RIRBCTL - RIRB Control Register	174
251	5Dh: RIRBSTS - RIRB Status Register	175
252	5Eh: RIRBSIZE - RIRB Size Register	175
253	60h: IC – Immediate Command Register	176
254	64h: IR – Immediate Response Register	176
255	68h: ICS – Immediate Command Status	176
256	70h: DPBASE – DMA Position Base Address Register	177
257	80h, A0h, C0h, E0h: ISD0CTL, ISD1CTL, OSD0CTL, OSD1CTL – Input/Output Stream Descriptor [0-1] Control Register	178
258	83h, A3h, C3h, E3h: ISD0STS, ISD1STS, OSD0STS, OSD1STS – Input/Output Stream Descriptor [0-1] Status Register	179
259	84h, A4h, C4h, E4h: ISD0LPIB, ISD1LPIB, OSD0LPIB, OSD1LPIB – Input/Output Stream Descriptor [0-1] Link Position in Buffer Register	180
260	88h, A8h, C8h, E8h: ISD0CBL, ISD1CBL, OSD0CBL, OSD1CBL– Input/Output Stream Descriptor [0-1] Cyclic Buffer Length Register	180
261	8Ch, ACh, CCh, ECh: ISD0LVI, ISD1LVI, OSD0LVI, OSD1LVI– Input/Output Stream Descriptor [0-1] Last Valid Index Register	181
262	8Eh, AEh, CEh, EEh: ISD0FIFOW, ISD1FIFOW, OSD0FIFOW, OSD1FIFOW– Input/Output Stream Descriptor [0-1] FIFO Watermark Register	181
263	90h, B0h: ISD0FIFOS, ISD1FIFOS – Input Stream Descriptor [0-1] FIFO Size Register	182
264	D0h, F0h: OSD0FIFOS, OSD1FIFOS – Output Stream Descriptor [0-1] FIFO Size Register	182
265	92h, B2h, D2h, F2h: ISD0FMT, ISD1FMT, OSD0FMT, OSD1FMT – Input/Output Stream Descriptor [0-1] Format Register	183
266	98h, B8h, D8h, F8h: ISD0BDPL, ISD1BDPL, OSD0BDPL, OSD1BDPL – Input/Output Stream Descriptor [0-1] Buffer Descriptor List Pointer Register	185
267	1000h: EM1 – Extended Mode 1 Register	185
268	1004h: INRC – Input Stream Repeat Count Register	186



269	1008h: OUTRC – Output Stream Repeat Count Register	187
270	100Ch: FIFOTRK – FIFO Tracking Register	187
271	1010h, 1014h, 1020h, 1024h: IODPIB, I1DPIB, OODPIB, O1DPIB – Input/Output Stream Descriptor [0-1] DMA Position in Buffer Register	188
272	1030h: EM2 – Extended Mode 2 Register	188
273	2030h: WLCLKA – Wall Clock Alias Register	188
274	2084h, 20A4h, 2104h, 2124h: ISD0LPIBA, ISD1LPIBA, OSD0LPIBA, OSD1LPIBA – Input/Output Stream Descriptor [0-1] Link Position in Buffer Alias Register	189
275	LPC Interface PCI Register Address Map	192
276	Offset 00h: ID – Identifiers	192
277	Offset 04h: CMD – Device Command	193
278	Offset 06h: STS – Device Status	193
279	Offset 08h: RID – Revision ID	193
280	Offset 09h: CC – Class Code	194
281	Offset 0Eh: HDTYPE – Header Type	194
282	Offset 2Ch: SS – Subsystem Identifiers	194
283	Offset 40h: SMBA – SMBus Base Address	195
284	Offset 44h: GBA – GPIO Base Address	195
285	Offset 48h: PM1BLK – PM1_BLK Base Address	195
286	Offset 4Ch: GPE0BLK – GPE0_BLK Base Address	196
287	Offset 54h: LPCS – LPC Clock Strength Control	196
288	Offset 58h: ACTL – ACPI Control	197
289	Offset 5Ch: MC – Miscellaneous Control	197
290	Offset 60h – 67h: PxRC – PIRQ[A-H] Routing Control	199
291	Offset 68h: SCNT – Serial IRQ Control	200
292	Offset 84h: WDTBA – WDT Base Address	200
293	Offset D0h: FS – FWH ID Select	200
294	Offset D4h: BDE – BIOS Decode Enable	201
295	Offset D8h: BC – BIOS Control	202
296	Offset F0h: RCBA – Root Complex Base Address	203
297	Timer I/O Registers	205
298	43h: TCW - Timer Control Word Register	206
299	43h: RBC – Read Back Command	207
300	43h: CLC – Counter Latch Command	207
301	40h, 41h, 42h: Interval Timer Status Byte Format Register	208
302	40h, 41h, 42h: Counter Access Ports Register	208
303	HPET Registers	210
304	000h: GCID – General Capabilities and ID	211
305	010h: GC – General Configuration	211
306	020h: GIS – General Interrupt Status	212
307	0F0h: MCV – Main Counter Value	212
308	100h, 120h, 140h: T[0-2]C – Timer [0-2] Config and Capabilities	212
309	108h, 128h, 148h: T[0-2]CV – Timer [0-2] Comparator Value	214
310	Timer Interrupt Mapping: Legacy Option	215
311	Master 8259 Input Mapping	216
312	Slave 8259 Input Mapping	216
313	8259 I/O Register Mapping	217
314	20h, A0h: ICW1 – Initialization Command Word 1	217
315	21h, A1h: ICW2 – Initialization Command Word 2	218
316	21h: MICW3 – Master Initialization Command Word 3	219
317	A1h: SICW3 – Slave Initialization Command Word 3	219
318	21h, A1h: ICW4 – Initialization Command Word 4 Register	219
319	21h, A1h: OCW1 – Operational Control Word 1 (Interrupt Mask)	220
320	20h, A0h: OCW2 – Operational Control Word 2	220
321	20h, A0h: OCW3 – Operational Control Word 3	221



322	4D0h: ELCR1 – Master Edge/Level Control.....	221
323	4D1h: ELCR2 – Slave Edge/Level Control	222
324	Content of Interrupt Vector Byte	223
325	APIC Registers.....	227
326	Index Registers	228
327	00h: ID – Identification Register	228
328	01h: VS – Version Register.....	228
329	10-11h – 3E-3Fh: RTE[0-23] – Redirection Table Entry	229
330	Interrupt Delivery Address Value.....	230
331	Interrupt Delivery Data Value	231
332	Serial Interrupt Mode Selection.....	232
333	Data Frame Format	233
334	RTC Registers.....	234
335	RTC Indexed Registers.....	235
336	0Ah: Register A	235
337	0Bh: Register B - General Configuration	236
338	0Ch: Register C - Flag Register	237
339	0Dh: Register D - Flag Register (RTC Well)	237
340	GPIO I/O Register	238
341	00h: CGEN – Core Well GPIO Enable.....	238
342	04h: CGIO – Core Well GPIO Input/Output Select.....	239
343	08h: CGLVL – Core Well GPIO Level for Input or Output	239
344	0Ch: CGTPE – Core Well GPIO Trigger Positive Edge Enable	239
345	10h: CGTNE – Core Well GPIO Trigger Negative Edge Enable	240
346	14h: CGGPE – Core Well GPIO GPE Enable	240
347	18h: CGSMI – Core Well GPIO SMI Enable.....	240
348	1Ch: CGTS – Core Well GPIO Trigger Status	241
349	Resume Well GPIO Registers	241
350	20h: RGEN – Resume Well GPIO Enable	241
351	24h: RGIO – Resume Well GPIO Input/Output Select	242
352	28h: RGLVL – Resume Well GPIO Level for Input or Output	242
353	2Ch: RGTPE – Resume Well GPIO Trigger Positive Edge Enable	243
354	30h: RGTNE – Resume Well GPIO Trigger Negative Edge Enable.....	243
355	34h: RGGPE – Resume Well GPIO GPE Enable.....	243
356	38h: RGSMI – Resume Well GPIO SMI Enable	244
357	3Ch: RGTS – Resume Well GPIO Trigger Status.....	244
358	SMBus Controller Registers.....	245
359	00h: HCTL - Host Control Register.....	245
360	01h: HSTS - Host Status Register.....	246
361	02h: HCLK – Host Clock Divider	247
362	04h: TSA - Transmit Slave Address	247
363	05h: HCMD - Command Register.....	247
364	06h: HD0 - Host Data 0	248
365	07h: HD1 - Host Data 1	248
366	20h – 3Fh: HBD – Host Block Data	248
367	SMBus Timings	249
368	SPI Pin Interface.....	250
369	GPIO Boot Source Selection.....	251
370	Instructions.....	252
371	SPI Cycle Timings	253
372	Bus 0, Device 31, Function 0, PCI Register Mapped Through RCBA BAR	254
373	00h: SPIS - SPI Status	254
374	02h: SPIC - SPI Control	255
375	04h: SPIA - SPI Address	256
376	08h: SPID0 - SPI Data 0	256

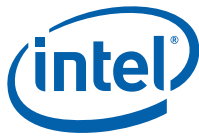

377	10h, 18h, 20h, 28h, 30h, 38h, 40h: SPID[0-6] - SPI Data [0-6]	257
378	50h: BBAR - BIOS Base Address	257
379	54h: PREOP - Prefix Opcode Configuration	258
380	56h: OPTYPE - Opcode Type	258
381	58h: OPMENU - OPCODE Menu Configuration	259
382	60h: PBR0 - Protected BIOS Range #0	259
383	Byte Enable Handling on Direct Memory Reads	261
384	Flash Protection Summary	263
385	Flash Erase Time	265
386	Flash Write Time	266
387	Watchdog Timer Register Summary: IA F Base (IO) View	268
388	00h: PV1R0 - Preload Value 1 Register 0	268
389	01h: PV1R1 - Preload Value 1 Register 1	269
390	02h: PV1R2 - Preload Value 1 Register 2	269
391	04h: PV2R0 - Preload Value 2 Register 0	270
392	05h: PV2R1 - Preload Value 2 Register 1	270
393	06h: PV2R2 - Preload Value 2 Register 2	270
394	0Ch: RR0 - Reload Register 0	271
395	0Dh: RR1 - Reload Register 1	271
396	10h: WDTCR - WDT Configuration Register	272
397	14h: DCR0 - Down Counter Register 0	272
398	15h: DCR1 - Down Counter Register 1	273
399	16h: DCR2 - Down Counter Register 2	273
400	18h: WDTLR - WDT Lock Register	273
401	Absolute Maximum Ratings	278
402	Memory Controller Buffer Types	279
403	Thermal Design Power	280
404	DC Current Characteristics	280
405	Operating Condition Power Supply and Reference DC Characteristics	281
406	Active Signal DC Characteristics	281
407	Pin List	294



Revision History

Date	Revision	Description
July 2011	004	<p>Updated Section 1.3.11, "General Purpose I/O (GPIO)" on page 29</p> <p>Updated Table 2, "Intel® Atom™ Processor E6xx Series SKU for Different Segments" on page 30</p> <p>Updated Table 11, "SPI Interface Signals" on page 36</p> <p>Updated Table 15, "Miscellaneous Signals and Clocks" on page 40</p> <p>Updated Table 16, "General Purpose I/O Signals" on page 43</p> <p>Updated Table 18, "Power and Ground Signals" on page 44</p> <p>Updated Table 34, "Intel® Atom™ Processor E6xx Series Clock Domains" on page 53</p> <p>Updated Table 36, "Memory Map" on page 57</p> <p>Updated Section 5.4.2.1, "PCI Config Space" on page 61</p> <p>Updated Table 71, "DRAM Address Decoder" on page 75</p> <p>Updated Table 79, "08h: GVD.RIDCC - Revision Identification and Class Code" on page 94</p> <p>Updated Table 107, "Offset 08h: RID - Revision Identification" on page 106</p> <p>Updated Table 108, "Offset 09h: CC - Class Codes" on page 106</p> <p>Updated Table 126, "PCI Type 1 Bridge Header" on page 114</p> <p>Updated Section 8.1.2.4, "SMI/SCI Generation" on page 114</p> <p>Updated Table 131, "Offset 08h: RID — Revision Identification" on page 117</p> <p>Updated Table 177, "Intel® High Definition Audio PCI Configuration Registers" on page 142</p> <p>Updated Table 182, "08h: RID – Revision Identification Register" on page 145</p> <p>Updated Table 275, "LPC Interface PCI Register Address Map" on page 192</p> <p>Updated Table 279, "Offset 08h: RID – Revision ID" on page 193</p> <p>Updated Section 10.3.4, "GPE0BLK—GPE0_BLK Base Address Register" on page 196</p> <p>Updated Section 11.9.4.1, "SPI Pin Level Protocol" on page 251</p> <p>Updated Table 368, "SPI Pin Interface" on page 250</p> <p>Updated Table 371, "SPI Cycle Timings" on page 253</p> <p>Updated Table 401, "Absolute Maximum Ratings" on page 278</p> <p>Updated Table 403, "Thermal Design Power" on page 280 - Table 406, "Active Signal DC Characteristics" on page 281</p>
January 2011	003	<p>Updated Table 2, "Intel® Atom™ Processor E6xx Series SKU for Different Segments" on page 30</p> <p>Updated Table 403, "Thermal Design Power" on page 280</p> <p>Updated Table 405, "Operating Condition Power Supply and Reference DC Characteristics" on page 281</p> <p>Updated Table 406, "Active Signal DC Characteristics" on page 281</p> <p>Added missing information to register tables in Chapter 7.0, "Graphics, Video, and Display," Chapter 11.0, "ACPI Devices."</p>
October 2010	002	<p>Updated Table 2, "Intel® Atom™ Processor E6xx Series SKU for Different Segments" on page 30</p> <p>Updated Table 15.</p> <p>Added an additional step in WDT mode — users need to program the preload value 1 register to all 0's.</p> <p>Added Overshoot/Undershoot specs</p> <p>Updated Table 34, "Intel® Atom™ Processor E6xx Series Clock Domains" on page 57</p> <p>Updated Section 5.3, "System Memory Map" on page 60</p> <p>Corrected PCI-E port number Section 8.1, "Functional Description" on page 131</p> <p>Changed PCI Express*-G to PCI Express* (removed 'G')</p> <p>Changed SDVO and Ref Clock Specs</p> <p>Added Premium SKU info</p> <p>Changed DC Characteristics Voltage Supply tolerance</p> <p>Changed SMB_CLK specs</p>
September 2010	001	Initial release





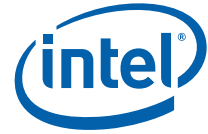

1.0 Introduction

The Intel® Atom™ Processor E6xx Series is the next-generation Intel® architecture (IA) CPU for the small form factor ultra low power embedded segments based on a new architecture partitioning. The new architecture partitioning integrates the 3D graphics engine, memory controller and other blocks with the IA CPU core. Please refer to subsequent chapters for a detailed description of functionality.

The processor departs from the proprietary chipset interfaces used by other IA CPUs to an open-standard, industry-proven PCI Express* v1.0 interface. This allows it to be paired with customer-defined IOH, ASIC, FPGA and off-the-shelf discrete components. This provides utmost flexibility in IO solutions. This is important for deeply embedded applications, in which IOs differ from one application to another, unlike traditional PC-like applications. Figure 1 shows an example system block diagram. Section 1.3 provides an overview of the major features of the processor.

Figure 1. System Block Diagram Example

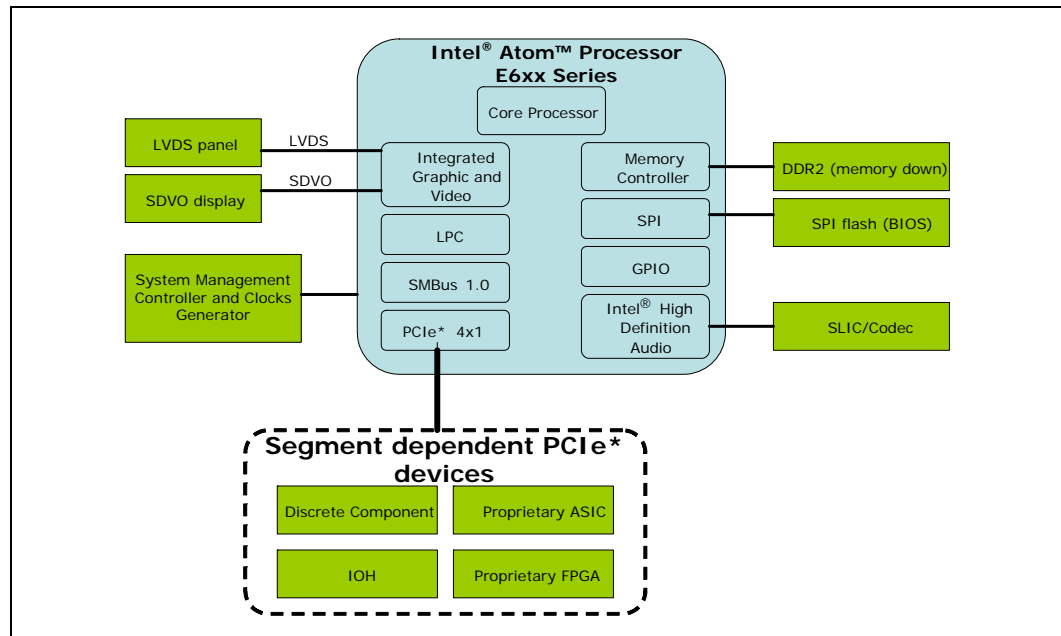

1.1 Terminology

Term	Description
ACPI	Advanced Configuration and Power Interface
ADD2	Advanced Digital Display 2. An interface specification that accepts serial DVO inputs and translates them into different display outputs such as DVO, TVOUT, and LVDS.
Cold Reset	Full reset is when PWROK is de-asserted and all system rails except VCCRTC are powered down
Core	A core is a processing unit that may include one or more logical processors (with or without Intel® Hyper-Threading Technology [™] (Intel® HT Technology [™])).
CRT	Cathode Ray Tube
CRU	Clock Reset Unit
DDR2	A second-generation Double Data Rate SDRAM memory technology.



Term	Description
DVI	Digital Video Interface. DVI is a specification that defines the connector and interface for digital displays.
EIOB	Electronic In/Out Board
HDMI	High Definition Multimedia Interface. HDMI supports standard, enhanced, or high-definition video, plus multi-channel digital audio on a single cable. HDMI transmits all Advanced Television Systems Committee (ATSC) HDTV standards and supports 8-channel digital audio, with bandwidth to spare for future requirements and enhancements (additional details available at http://www.hdmi.org/).
IA	Intel® architecture
IGD	Internal Graphics Unit
Intel® Thermal Monitor 2	Intel® Thermal Monitor 2 is a feature of the Intel® Atom™ Processor E6xx Series. The Intel® Thermal Monitor 2 contains the Enhanced Thermal Control Circuit (TCC). When the Monitor is enabled and active due to the die temperature reaching the pre-determined activation temperature, the Enhanced TCC attempts to cool the processor by first reducing the core to a specific bus ratio, then stepping down the VID.
Intel® Hyper-Threading Technology ^α (Intel® HT Technology ^α)	Intel® Hyper-Threading Technology ^α (Intel® HT Technology ^α) enables two logical processors in a core.
Intel® Thermal Monitor	Intel® Thermal Monitor is a feature of the Intel® Atom™ Processor E6xx Series. The Intel® Thermal Monitor contains the Thermal Control Circuit (TCC). When the Monitor is enabled and active due to the die temperature reaching the pre-determined activation temperature, the TCC attempts to cool the processor by stopping the processor clocks for a period of time and then allowing them to run full speed for a period of time (duty cycle ~30% – 50%) until the processor temperature drops below the activation temperature.
LCD	Liquid Crystal Display
LVDS	Low Voltage Differential Signaling. LVDS is a high speed, low power data transmission standard used for display connections to LCD panels.
MPEG	Moving Picture Experts Group
MSI	Message Signaled Interrupt. MSI is a transaction initiated outside the host, conveying interrupt information to the receiving agent through the same path that normally carries read and write commands.
MSR	Model Specific Register, as the name implies, is model-specific and may change from processor model number (n) to processor model number (n+1). An MSR is accessed by setting ECX to the register number and executing either the RDMSR or WRMSR instruction. The RDMSR instruction will place the 64 bits of the MSR in the EDX: EAX register pair. The WRMSR writes the contents of the EDX: EAX register pair into the MSR.
PCI Express*	PCI Express* (PCIe*) is a high-speed serial interface. The PCIe* configuration is software-compatible with the existing PCI specifications.
Rank	A unit of DRAM corresponding to a number of SDRAM devices in parallel such that a full 64-bit data bus is formed.
SCI	System Control Interrupt. SCI is used in the ACPI protocol.
SDRAM	Synchronous Dynamic Random Access Memory
SDVO	Serial Digital Video Out. SDVO is a digital display channel that serially transmits digital display data to an external SDVO device. The SDVO device accepts this serialized format and then translates the data into the appropriate display format (i.e., TMDS, LVDS, TV-Out).
SDVO Device	Third-party codec that uses SDVO as an input; may have a variety of output formats, including DVI, LVDS, HDMI, TV-Out, etc.
SERR	System Error. SERR is an indication that an unrecoverable error has occurred on an I/O bus.
SMC	System Management Controller or External Controller refers to a separate system management controller that handles reset sequences, sleep state transitions, and other system management tasks.

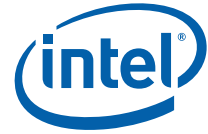

Term	Description
SMI	System Management Interrupt is used to indicate any of several system conditions (such as thermal sensor events, throttling activated, access to System Management RAM, chassis open, or other system state related activity).
TDMA	Time Division Multiple Access
TEL	Throttle Enforcement Limit
TCC	Thermal Control Circuit. A feature of the Intel® Atom™ Processor E6xx Series that is used to cool the processor should its temperature exceed a predetermined activation temperature.
TMDS	Transition Minimized Differential Signaling. TMDS is a signaling interface from Silicon Image* that is used in DVI and HDMI. TMDS is based on low-voltage differential signaling and converts an 8-bit signal into a 10-bit transition minimized and DC-balanced signal (equal number of 0s and 1s) in order to reduce EMI generation and improve reliability.
VCO	Voltage Controlled Oscillator
Intel® VT [®]	Intel® Virtualization Technology [®]
Warm Reset	Warm reset is when both RESET_B and PWROK are asserted.

1.2 Reference Documents

Document	Document Number / Location
<i>Advanced Configuration and Power Interface, Version 3.0 (ACPI)</i>	http://www.acpi.info/spec.htm
<i>IA-PC HPET (High Precision Event Timers) Specification, Revision 1.0</i>	http://www.intel.com/hardware/design/hpetspec_1.pdf
<i>Intel® Atom™ Processor E6xx Series Specification Update</i>	http://download.intel.com/embedded/processor/specupdate/324209.pdf
<i>Intel® Atom™ Processor E6xx Series Thermal and Mechanical Design Guidelines</i>	http://download.intel.com/embedded/processor/designguide/324210.pdf
<i>Low Pin Count Interface Specification, Revision 1.1 (LPC)</i>	http://developer.intel.com/design/chipsets/industry/lpc.htm
<i>PCI Express* Base Specification, Rev. 1.0a</i>	http://www.pcisig.com/specifications
<i>System Management Bus Specification, Version 1.0 (SMBus)</i>	http://www.smbus.org/specs/

Notes:

- Contact your Intel Field Representative for the latest version of this document.

1.3 Components Overview

The Intel® Atom™ Processor E6xx Series incorporates a variety of PCI functions as listed in [Table 1](#).

Table 1. PCI Devices and Functions

Device	Function	Function Description
0	0	Host Bridge
2	0	Integrated Graphics and Video Device
3	0	SDVO Display Unit
23	0	PCI Express* Port 0
24	0	PCI Express* Port 1
25	0	PCI Express* Port 2

Table 1. PCI Devices and Functions

Device	Function	Function Description
26	0	PCI Express* Port 3
27	0	Intel® High Definition Audio ^β (Intel® HD Audio ^β) Controller
31	0	LPC interface

Note: All devices are on PCI Bus 0

Figure 2. Components of the Intel® Atom™ Processor E6xx Series

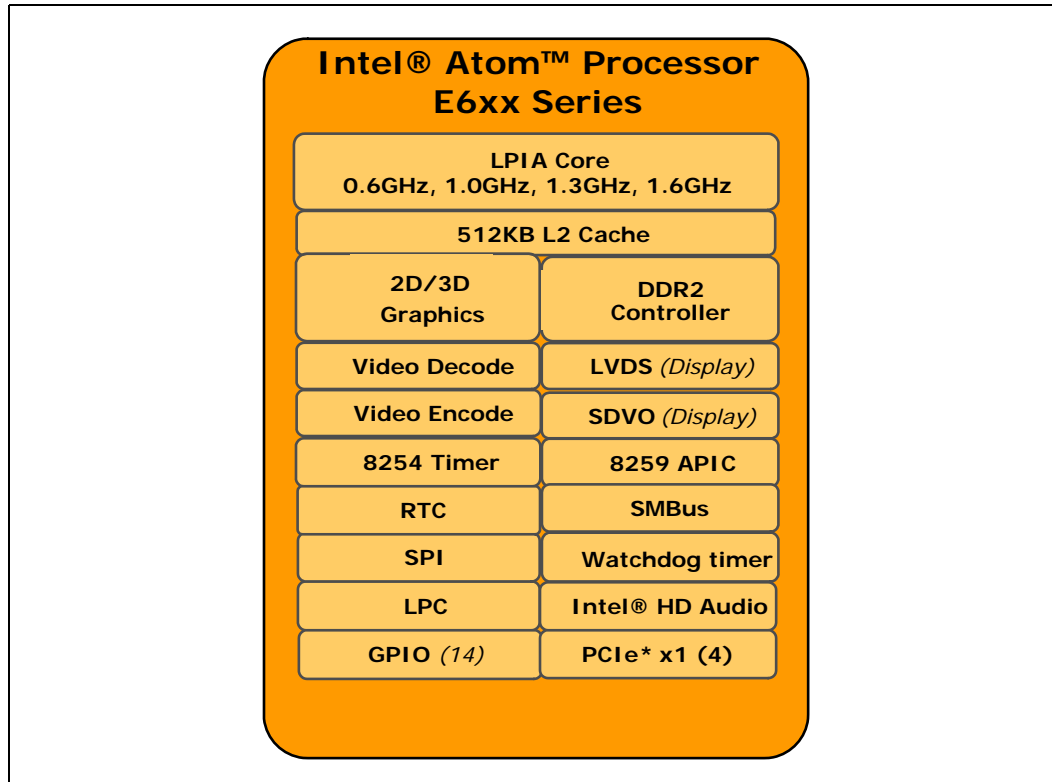

1.3.1 Low-Power Intel® Architecture Core

- 600 MHz (Ultra Low Power SKU), 1.0 GHz (Entry SKU), 1.3 GHz (Mainstream SKU) and 1.6 GHz (Premium SKU)
- Macro-operation execution support
- 2-wide instruction decode and in-order execution
- On die, 32 kB 4-way L1 Instruction Cache and 24 kB 6-way L1 Data Cache
- On die, 512 kB, 8-way L2 cache
- L2 Dynamic Cache Sizing
- 32-bit physical address, 48-bit linear address size support
- Support for IA 32-bit architecture
- Supports Intel® Virtualization Technology^δ (Intel® VT-x^δ)
- Supports Intel® Hyper-Threading Technology^α — two threads



- Advanced power management features including Enhanced Intel SpeedStep® Technology⁶
- Deep Power Down Technology (C6)
- Intel® Streaming SIMD Extension 2 and 3 (Intel® SSE2 and Intel® SSE3) and Supplemental Streaming SIMD Extensions 3 (SSSE3) support

1.3.2 System Memory Controller

- Single-channel DDR2 memory controller
- 32-bit data bus
- Supports DDR2 800 MT/s data rates
- Supports 1 or 2 ranks
- Supports x8 or x16 DRAM chips
- One rank - two x16 or four x8 DRAM chips
- Two ranks - two x16 DRAM chips per rank, or four x8 DRAM chips per rank
- Supports up to 2 GB of extended memory
- Supports total memory size of 128 MB, 256 MB, 512 MB, 1 GB and 2 GB
- Supports 256 Mb, 512 Mb, 1 Gb and 2 Gb chip densities for the x8 DRAM
- Supports 512 Mb, 1 Gb and 2 Gb chip densities for the x16 DRAM
- Aggressive power management to reduce power consumption, including shallow self-refresh and a new deep self-refresh support
- Proactive page closing policies to close unused pages
- Supports partial writes through data mask pins
- Supports only soldered-down DRAM configurations. The memory controller does not support SODIMM or any type of DIMMs.

1.3.3 Graphics

The Intel® Atom™ Processor E6xx Series provides integrated 2D/3D graphic engine that performs pixel shading and vertex shading within a single hardware accelerator. The processing of pixels is deferred until they are determined to be visible, which minimizes access to memory and improves render performance.

1.3.4 Video Decode

The Intel® Atom™ Processor E6xx Series supports MPEG2, MPEG4, VC1, WMV9, H.264 (main, baseline at L3 and high-profile level 4.0/4.1), and DivX*.

1.3.5 Video Encode

The Intel® Atom™ Processor E6xx Series supports MPEG4, H.264 (baseline at L3), and VGA.

1.3.6 Display Interfaces

The Intel® Atom™ Processor E6xx Series supports LVDS and Serial DVO display ports permitting simultaneous independent operation of two displays.



1.3.6.1 LVDS Interface

The Intel® Atom™ Processor E6xx Series supports a Low-Voltage Differential Signaling interface that allows the Graphics and Video adaptor to communicate directly to an on-board flat-panel display. The LVDS interface supports pixel color depths of 18 and 24 bits, maximum resolution up to 1280x768 @ 60 Hz. Minimum pixel clock is 19.75 MHz. Maximum pixel clock rate up to 80 MHz.

The processor does provides LVDS backlight control related signal in order to support LVDS panel backlight adjustment.

1.3.6.2 Serial DVO (SDVO) Display Interface

Digital display channel capable of driving SDVO adapters that provide interfaces to a variety of external display technologies (e.g., DVI, TV-Out, analog CRT). Maximum resolution up to 1280x1024 @ 85 Hz. Maximum pixel clock rate up to 160 MHz.

SDVO lane reversal is not supported.

1.3.7 PCI Express*

The Intel® Atom™ Processor E6xx Series has four x1 lane PCI Express* (PCIe*) root ports supporting the *PCI Express* Base Specification*, Rev. 1.0a. The processor does not support the “ganging” of PCIe* ports. The four x1 PCIe* ports operate as four independent PCIe* controllers. Each root port supports up to 2.5 Gb/s bandwidth in each direction per lane.

The PCIe* ports may be used to attach discrete I/O components or a custom I/O Hub for increased I/O expansion.

1.3.8 LPC Interface

The Intel® Atom™ Processor E6xx Series implements an LPC interface as described in the *LPC1.1 Specification*.

The LPC interface has three PCI-based clock outputs that may be provided to different I/O devices such as legacy I/O chip. The LPC_CLKOUT signals support a total of six loads (two loads per clock pair) with no external buffering.

1.3.9 Intel® High Definition Audio^β (Intel® HD Audio^β) Controller

The *Intel® High Definition Audio^β Specification* defines a digital interface that can be used to attach different types of codecs (such as audio and modem codecs). The Intel® HD Audio^β controller supports up to four audio streams, two in and two out.

With the support of multi-channel audio stream, 32-bit sample depth, and sample rate up to 192 kHz, the Intel® High Definition Audio^β (Intel® HD Audio^β) controller provides audio quality that can deliver consumer electronic (CE) levels of audio experience. On the input side, the Intel® Atom™ Processor E6xx Series adds support for an array of microphones.

The Intel® HD Audio^β controller uses a set of DMA engines to effectively manage the link bandwidth and support simultaneous independent streams on the link. The Intel® HD Audio^β controller also supports isochronous data transfers allowing glitch-free audio to the system.

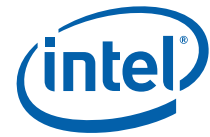

1.3.10 SMBus Host Controller

The Intel® Atom™ Processor E6xx Series contains an SMBus host interface that allows the processor to communicate with SMBus slaves. This interface is compatible with most I²C* devices.

The SMBus host controller provides a mechanism for the processor to initiate communications with SMBus peripherals (slaves). See the *System Management Bus (SMBus) Specification*, Version 1.0.

1.3.11 General Purpose I/O (GPIO)

The Intel® Atom™ Processor E6xx Series contains a total of 14 GPIO pins.

Five of these GPIOs are powered by core power rail and are turned off during sleep mode (S3 and higher). Nine of these GPIOs are powered by the suspend power well and remained active during S3. Five of the GPIOs in suspend power well can be used to wake the system from the Suspend-to-RAM state, provided that current OS will not clear the GPE0E register before entering S3 state. The five GPIOs that can be use are GPIO_SUS[1], GPIO_SUS[2], GPIO_SUS[3], GPIO_SUS[4] and GPIO_SUS[7]. GPIO_SUS[4: 1] can be use to wake the system from Suspend-to-RAM state provided LVDS is disabled on the platform as these signals are being used by LVDS display.

The GPIOs are not 5 V tolerant.

1.3.12 Serial Peripheral Interface (SPI)

The Intel® Atom™ Processor E6xx Series contains an SPI interface that supports boot from SPI flash. This interface only supports BIOS boot.

1.3.13 Power Management

The Intel® Atom™ Processor E6xx Series contains a mechanism to allow flexible configuration of various device maintenance routines as well as power management functions including enhanced clock control and low-power state transitions (e.g., Suspend-to-RAM and Suspend-to-Disk). A hardware-based thermal management circuit permits software-independent entrance to low-power states. The processor contains full support for the *Advanced Configuration and Power Interface (ACPI) Specification*, Revision 3.0.

1.3.14 Watchdog Timer (WDT)

The Intel® Atom™ Processor E6xx Series supports a user configurable watchdog timer. It contains selectable prescaler approximately 1 μ s to 10 min. When the WDT triggers, GPIO[4] is asserted.

1.3.15 Real Time Clock (RTC)

The Intel® Atom™ Processor E6xx Series supports a RTC that provides a battery backed-up date and time keeping device. The time keeping comes from a 32.768 kHz oscillating source.

1.3.16 Package

The Intel® Atom™ Processor E6xx Series comes in an Flip-Chip Ball Grid Array (FCBGA) package and consists of a silicon die mounted face down on an organic substrate populated with 676 solder balls with 0.8 mm ball pitch on the bottom side. The package dimensions are 22 mm x 22 mm, Z-height is 2.097 mm - 2.35 mm.

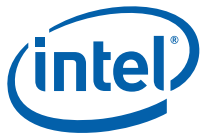

1.3.17 Intel® Atom™ Processor E6xx Series SKU

Table 2. Intel® Atom™ Processor E6xx Series SKU for Different Segments

SKU	E620	E640	E660	E680	E620T	E640T	E660T	E680T
Core Frequency (GHz)	0.6	1.0	1.3	1.6	0.6	1.0	1.3	1.6
L2 Cache (KB)	512	512	512	512	512	512	512	512
Memory Frequency (MHz)	800	800	800	800	800	800	800	800
Maximum Memory Size (GB)	2	2	2	2	2	2	2	2
Gfx. Frequency (MHz)	320	320	400	400	320	320	400	400
Video Decode Frequency (MHz)	267	267	267	267	267	267	267	267
Video Encode Frequency (MHz)	Disabled	267	267	267	Disabled	267	267	267
PCIe* ports	4	4	4	4	4	4	4	4
Intel® Hyper-Threading Technology ^α	Yes	Yes	Yes	Yes	Yes	Yes	Yes	Yes
Intel® VT-x ^δ (requires software support)	Yes	Yes	Yes	Yes	Yes	Yes	Yes	Yes
Commercial Temperature (0 to 70 °C)	Yes	Yes	Yes	Yes	No	No	No	No
Extended Temperature (-40 to 85 °C)	No	No	No	No	Yes	Yes	Yes	Yes
TDP (W)	3.3 ¹	3.6	3.6	4.5 ¹	3.3 ¹	3.6	3.6	4.5 ¹

Notes:

1. TDP for E620, E620T, E680 and E680T are estimates.





2.0 Signal Description

This chapter provides a detailed description of the signals and boot strap definitions. The processor signals are arranged in functional groups according to their associated interface.

Each signal description table has the following headings:

- **Signal:** The name of the signal/pin
- **Type:** The buffer direction and type. Buffer direction can be either input, output, or I/O (bidirectional). See [Table 3](#) for definitions of the different buffer types.
- **Power Well:** The power plane used to supply power to that signal. Choices are core, DDR, Suspend, and RTC.
- **Description:** A brief explanation of the signal's function

Table 3. Buffer Types

Buffer Type	Buffer Description
AGTL+	Assisted Gunning Transceiver Logic Plus. CMOS Open Drain interface signals that require termination. Refer to the AGTL+ I/O Specification for complete details.
CMOS, CMOS_OD	1.05-V CMOS buffer, or CMOS Open Drain
CMOS_HDA	CMOS buffers for Intel® HD Audio ^β interface that can be configured for either 1.5-V or 3.3-V operation. The processor will only support 3.3-V
CMOS1.8	1.8-V CMOS buffer. These buffers can be configured as Stub Series Termination Logic (SSTL1.8)
CMOS3.3, CMOS3.3_OD	3.3-V CMOS buffer, or CMOS 3.3-V open drain
CMOS3.3-5	3.3-V CMOS buffer, 5-V tolerant
PCIe*	PCI Express* interface signals. These signals are compatible with <i>PCI Express* Base Specification, Rev. 1.0a Signaling Environment AC Specifications</i> and are AC coupled. The buffers are not 3.3-V tolerant.
SDVO	Serial-DVO differential buffers. These signals are AC coupled. These buffers are not 3.3-V tolerant.
LVDS	Low Voltage Differential Signal output buffers. These pure outputs should drive across a 100-Ω resistor at the receiver when driving.
A	Analog reference or output maybe used as a threshold voltage or for buffer compensation.

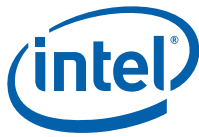

2.1 System Memory Signals

Table 4. System Memory Signals

Signal	Direction/Type	Power Well	Description
M_ODT[1:0]	O CMOS1.8	Core	On-Die Termination Enable: (active high) One pin per rank (2 ranks supported)
M_CKP	O CMOS1.8	Core	Differential DDR Clock: The crossing of the positive edge of M_CKP and the negative edge of M_CKN is used to sample the address and control signals on memory.
M_CKN	O CMOS1.8	Core	Complementary Differential DDR Clock
M_CKE[1:0]	O CMOS1.8	SUS	Clock Enable: (active high) M_CKE is used for power control of the DRAM devices. There is one M_CKE per rank.
M_SRFWEN	I CMOS1.8	SUS	S3 Firewall Enable: DDR in self-refresh enable signal. Should be connected to VCC180SR with an external pull-up resistor.
M_CSB[1:0]	O CMOS1.8	Core	Chip Select: These signals determine whether a command is valid in a given cycle for the devices connected to it. There is one M_CSB for each rank.
M_RASB	O CMOS1.8	Core	Row Address Strobe: (active low) This signal is used with M_CASB and M_WEB (along with M_CSB) to define commands.
M_CASB	O CMOS1.8	Core	Column Address Strobe: (active low) This signal is used with M_RASB, M_WEB, and M_CSB to define commands.
M_WEB	O CMOS1.8	Core	Write Enable: (active low) Used with M_CASB, M_RASB, and M_CSB to define commands.
M_BS[2:0]	O CMOS1.8	Core	Bank Select: (active high) Defines which banks are being addressed within each rank. (Some call this Bank Address (M_BA))
M_MA[14:0]	O CMOS1.8	Core	Multiplexed Address: Provides multiplexed row and column address to memory.
M_DQ[31:0]	I/O CMOS1.8	Core	Data Lines: M_DQ signals interface to the DRAM data bus
M_DQS[3:0]	I/O CMOS1.8	Core	Data Strobes: These signals are used during writes, driven by the processor, offset so as to be centered in the data phase. During reads, these signals are driven by memory devices edge aligned with data. The following list matches the data strobe with the data bytes. M_DQS[3] matches M_DQ[31:24] M_DQS[2] matches M_DQ[23:16] M_DQS[1] matches M_DQ[15:8] M_DQS[0] matches M_DQ[7:0]
M_DM[3:0]	I/O CMOS1.8	Core	Data Mask: One bit per byte indicating which bytes should be written.
M_RCVENIN	I CMOS1.8	Core	Receive Enable In: (active high) Connects to M_RCVENOUT on the motherboard. This input enables the M_DQS input buffers during reads.
M_RCVENOUT	O CMOS1.8	Core	Receive Enable Out: (active high) Connects to M_RCVENIN on the motherboard. Part of the feedback used to enable the M_DQS input buffers during reads.
M_RCOMPOT	I A	Core	RCOMPOT: Connected to a reference resistor to dynamically calibrate the driver strengths.

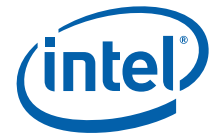

2.2 Integrated Display Interfaces

2.2.1 LVDS Signals

Table 5. LVDS Signals

Signal	Direction/Type	Power Well	Description
LVD_DATAN_0	O LVDS	Core	Channel A Differential Data Output (Negative): Differential signal pair.
LVD_DATAN_1	O LVDS	Core	Channel A Differential Data Output (Negative): Differential signal pair.
LVD_DATAN_2	O LVDS	Core	Channel A Differential Data Output (Negative): Differential signal pair.
LVD_DATAN_3	O LVDS	Core	Channel A Differential Data Output (Negative): Differential signal pair.
LVD_DATAP_0	O LVDS	Core	Channel A Differential Data Output (Positive): Differential signal pair.
LVD_DATAP_1	O LVDS	Core	Channel A Differential Data Output (Positive): Differential signal pair.
LVD_DATAP_2	O LVDS	Core	Channel A Differential Data Output (Positive): Differential signal pair.
LVD_DATAP_3	O LVDS	Core	Channel A Differential Data Output (Positive): Differential signal pair.
LVD_CLKN	O LVDS	Core	Channel A Differential Clock Output (Negative): Differential signal pair.
LVD_CLKP	O LVDS	Core	Channel A Differential Clock Output (Positive): Differential signal pair.
LVD_IBG	I A	Core	Reference Current: Resistor on motherboard
LVD_VBG	I Power	Core	External Voltage Ref BG: 1.25 V ± 1.5%
LVD_VREFL	I A	Core	VREFL: Needed for analog loop back
LVD_VREFH	I A	Core	VREFH: Needed for analog loop back



2.2.2 Serial Digital Video Output (SDVO) Signals

Table 6. Serial Digital Video Output Signals

Signal Name	Direction/Type	Power Well	Description
SDVO_REDP SDVO_REDN	O PCIe*	Core	Serial Digital Video Red: SDVO_RED[±] is a differential data pair that provides red pixel data for the SDVO channel during Active periods. During blanking periods it may provide additional such as sync information, auxiliary configuration data, etc. This data pair must be sampled with respect to the SDVO_CLK[±] signal pair.
SDVO_GREENP SDVO_GREENN	O PCIe*	Core	Serial Digital Video Green: SDVO_GREEN[±] is a differential data pair that provides green pixel data for the SDVO channel during Active periods. During blanking periods it may provide additional such as sync information, auxiliary configuration data, etc. This data pair must be sampled with respect to the SDVO_CLK[±] signal pair.
SDVO_BLUEP SDVO_BLUEN	O PCIe*	Core	Serial Digital Video Blue: SDVO_BLUE[±] is a differential data pair that provides blue pixel data for the SDVO channel during Active periods. During blanking periods it may provide additional such as sync information, auxiliary configuration data, etc. This data pair must be sampled with respect to the SDVO_CLK[±] signal pair.
SDVO_CLKP SDVO_CLKN	O PCIe*	Core	Serial Digital Video Clock: This differential clock signal pair is generated by the internal PLL and runs between 100 MHz and 200 MHz. If TV-out mode is used, the SDVO_TVCLKIN[±] clock input is used as the frequency reference for the PLL. The SDVO_CLK[±] output pair is then driven back to the SDVO device.
SDVO_INTTP SDVO_INTN	I PCIe*	Core	Serial Digital Video Input Interrupt: Differential input pair that may be used as an interrupt notification from the SDVO device. This signal pair can be used to monitor hot plug attach/detach notifications for a monitor driven by an SDVO device.
SDVO_TVCLKINP SDVO_TVCLKINN	I PCIe*	Core	Serial Digital Video TV-OUT Synchronization Clock: Differential clock pair that is driven by the SDVO device. If SDVO_TVCLKIN[±] is used, it becomes the frequency reference for the dot clock PLL, but will be driven back to the SDVO device through the SDVO_CLK[±] differential pair. This signal pair has an operating range of 100–200 MHz, so if the desired display frequency is less than 100 MHz, the SDVO device must apply a multiplier to get the SDVO_TVCLKIN[±] frequency into the 100- to 200-MHz range.
SDVO_STALLP SDVO_STALLN	I PCIe*	Core	Serial Digital Video Field Stall: Differential input pair that allows a scaling SDVO device to stall the pixel pipeline.
SDVO_CTRLCLK	I/O CMOS3.3_OD	Core	SDVO Control Clock: Single-ended control clock line to the SDVO device. Similar to I ² C* clock functionality, but may run at faster frequencies. SDVO_CTRLCLK is used in conjunction with SDVO_CTRLDATA to transfer device config, PROM, and monitor DDC information. This interface directly connects to the SDVO device.
SDVO_CTRLDATA	I/O CMOS3.3_OD	Core	SDVO Control Data: SDVO_CTRLDATA is used in conjunction with SDVO_CTRLCLK to transfer device config, PROM, and monitor DDC information. This interface directly connects to the SDVO device.
SDVO_REFCLKP SDVO_REFCLKN	I SDVO	Core	SDVO Reference Clock: Display PLL Positive/Negative Ref Clock



2.3 PCI Express* Signals

Table 7. PCI Express* Signals

Signal Name	Direction/Type	Power Well	Description
PCIE_PETp[3:0] PCIE_PETn[3:0]	O PCIe*	Core	PCI Express* Transmit: PCIE_PET[3:0] are PCI Express* Ports 3:0 transmit pair (P and N) signals.
PCIE_PERp[3:0] PCIE_PERn[3:0]	I PCIe*	Core	PCI Express* Receive: PCIE_PER[3:0] PCI Express* Ports 3:0 receive pair (P and N) signals.
PCIE_CLKINP PCIE_CLKINN	I PCIe*	Core	PCI Express* Input Clock: 100-MHz differential clock signals.
PCIE_ICOMPO	I/O A	Core	PCI Express* Compensation Pin: Output compensation for both current and resistance.
PCIE_ICOMPI	I/O A	Core	PCI Express* Compensation Pin: Input compensation for current.
PCIE_RCOMPO	I/O A	Core	PCI Express* Compensation Pin: PCI Express* Resistance Compensation
PCIE_RBIAS	I/O A	Core	PCI Express* Compensation Pin: PCI Express* Bias control

2.4 Intel® High Definition Audio^β Interface Signals

Table 8. Intel® High Definition Audio^β Interface Signals

Signal Name	Direction/Type	Power Well	Description
HDA_RST_B	O CMOS_HDA	Core	Intel® HD Audio^β Reset: This signal is the reset to external codecs
HDA_SYNC	O CMOS_HDA	Core	Intel® HD Audio^β Sync: This signal is an 48-kHz fixed rate sample sync to the codec(s). It is also used to encode the stream number.
HDA_CLK	O CMOS_HDA	Core	Intel® HD Audio^β Clock (Output): This signal is a 24.000 MHz serial data clock generated by the Intel® HD Audio ^β controller. This signal contains an integrated pull-down resistor so that it does not float when an Intel® HD Audio ^β codec (or no codec) is connected.
HDA_SDO	O CMOS_HDA	Core	Intel® HD Audio^β Serial Data Out: This signal is a serial TDM data output to the codec(s). The serial output is double-pumped for a bit rate of 48 MB/s for Intel® HD Audio ^β .
HDA_SDI[1:0]	I CMOS_HDA	Core	Intel® HD Audio^β Serial Data In: These serial inputs are single-pumped for a bit rate of 24 MB/s. They have integrated pull-down resistors that are always enabled.
HDA_DOCKEN_B	O CMOS_HDA	Core	Intel® HD Audio^β Dock Enable: This active low signal controls the external Intel® HD Audio ^β docking isolation logic. When deasserted, the external docking switch is in isolate mode. When asserted, the external docking switch electrically connects the Intel® HD Audio ^β dock signals to the corresponding processor signals.
HDA_DOCKRST_B	O CMOS_HDA	Core	Intel® HD Audio^β Dock Reset: This signal is a dedicated reset signal for the codec(s) in the docking station. It works similar to, but independent of, the normal HDA_RST_B signal.



2.5 LPC Interface Signals

Table 9. LPC Interface Signals

Signal Name	Direction/Type	Power Well	Description
LPC_AD[3:0]	I/O CMOS3.3	Core	LPC Address/Data: Multiplexed Command, Address, Data
LPC_FRAME_B	O CMOS3.3	Core	LPC Frame: This signal indicates the start of an LPC cycle.
LPC_SERIRQ	I/O CMOS3.3	Core	Serial Interrupt Request: This signal conveys the serial interrupt protocol.
LPC_CLKRUN_B	I/O CMOS3.3	Core	Clock Run: This signal gates the operation of the LPC_CLKOUTx. Once an interrupt sequence has started, LPC_CLKRUN_B should remain asserted to allow the LPC_CLKOUTx to run.
LPC_CLKOUT[2:0]	O CMOS3.3	Core	LPC Clock: These signals are the clocks driven by the processor to LPC devices. Each clock can support up to two loads. Note: The primary boot device like SPI (behind SMC) should be connected to LPC_CLKOUT[0]

Note: Boot from LPC is not supported.

2.6 SMBus Interface Signals

Table 10. SMBus Interface Signals

Signal Name	Direction/Type	Power Well	Description
SMB_DATA	I/O CMOS3.3_OD	Core	SMBus Data: This signal is the SMBus data pin. An external pull-up resistor is required.
SMB_CLK	I/O CMOS3.3_OD	Core	SMBus Clock: This signal is the SMBus clock pin. An external pull-up resistor is required.
SMB_ALERT_B	I CMOS3.3	Core	SMBus Alert: This signal can be used to generate an interrupt, or generate an SMI_B.

2.7 SPI Interface Signals

Table 11. SPI Interface Signals

Signal Name	Direction/Type	Power Well	Description
SPI_MOSI	O CMOS3.3	Core	SPI Data Output: Unidirectional output data for the SPI IF.
SPI_MISO	I CMOS3.3	Core	SPI Data Input: Unidirectional input data for the SPI IF.
SPI_CS_B	O CMOS3.3	Core	SPI Chip Select Signal: When asserted low, the SPI peripheral is selected.
SPI_SCK	O CMOS3.3	Core	SPI Clock Output: Serial clock accompanying data.



2.8 Power Management Interface Signals

Table 12. Power Management Interface Signals

Signal Name	Direction/ Type	Power Well	Description
RESET_B	I CMOS3.3	SUS	System Reset: Active Low Hard Reset for the processor. When asserted, the processor will immediately initialize itself and return to its default state. This signal is driven by the Power Management IC.
PWROK	I CMOS3.3	RTC	Power OK: When asserted, PWROK is an indication to the system that core power is stable. PWROK can be driven asynchronously.
RSMRST_B	I CMOS3.3	RTC	Resume Well Reset: This signal is used for resetting the resume well. An external RC circuit is required to ensure that the resume well power is valid prior to RSMRST_B going high.
RTCRST_B	I CMOS3.3	RTC	RTC Well Reset: This signal is normally held high, but can be driven low on the motherboard to test the RTC power well and reset some bits in the RTC well registers that are otherwise not reset by SLPMODE or RSMRST_B. An external RC circuit on the RTCRST_B signal creates a time delay such that RTCRST_B will go high some time after the battery voltage is valid. This allows the chip to detect when a new battery has been installed. The RTCRST_B input must always be high when other non-RTC power planes are on.
SUSCLK	O CMOS3.3	SUS	Suspend Clock: This signal is an output of the RTC generator circuit (32.768 kHz). SUSCLK can have a duty cycle from 30% to 70%.
WAKE_B	I CMOS3.3	SUS	PCI Express* Wake Event: This signal indicates a PCI Express* port wants to wake the system. This is a single signal that can be driven by any of the devices sitting on the PCIe* slots on the board. It is normally pulled high (by the devices), but any devices that need to wake the processor will drive this signal low.
SLPMODE	O CMOS3.3	SUS	Sleep Mode: SLPMODE determines which sleep state is entered. When SLPMODE is high, S3 will be chosen. When SLPMODE is low, S4/S5 will be the selected sleep mode.
RSTWARN	I CMOS3.3	SUS	Reset Warning: Asserting the RSTWARN signal tells the chip to enter a sleep state or begin to power down. A system management controller might do so after an external event, such as pressing of the power button or occurrence of a thermal event.
SLPRDY_B	O CMOS3.3	SUS	Sleep Ready: The processor will drive the SLPRDY_B signal low to indicate to the system management controller that the processor is awake and able to be placed into a sleep state. Deassertion of this signal indicates that a wake is being requested from a system device.
RSTRDY_B	O CMOS3.3	SUS	Reset Ready: Assertion of the RSTRDY_B signal indicates to the system management controller that it is ready to be placed into a low power state. During a transition from S0 to S3/4/5 sleep states, the chip asserts RSTRDY_B and CPURST_B after detecting assertion of the RSTWARN signal from the external system management controller.
GPE_B	I CMOS3.3_OD	SUS	General Purpose Event: GPE_B is asserted by an external device (typically, the system management controller) to log an event in the chip's ACPI space and cause an SCI (if enabled).

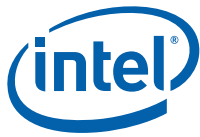

2.9 Real Time Clock Interface Signals

Table 13. Real Time Clock Interface Signals

Signal Name	Direction/ Type	Power Well	Description
RTCX1	Special A	RTC	Crystal Input 1: This signal is connected to the 32.768-kHz crystal. If no external crystal is used, then RTCX1 can be driven with the desired clock rate.
RTCX2	Special A	RTC	Crystal Output 2: This signal is connected to the 32.768-kHz crystal. If no external crystal is used, then RTCX2 should be left floating.
VCCRTCEXT	I Power	RTC	External capacitor connection

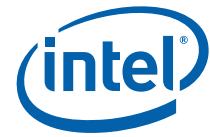

2.10 JTAG and Debug Interface

The JTAG interface is accessible only after PWROK is asserted.

Table 14. JTAG and Debug Interface Signals

Signal Name	Direction/ Type	Power Well	Description
TCK	I CMOS	Core	CPU JTAG Test Clock: Provides the clock input for the processor Test Bus (also known as the Test Access Port).
TDI	I CMOS	Core	CPU JTAG Test Data Input: Transfers serial test data into the processor. TDI provides the serial input needed for JTAG specification support.
TDO	O CMOS_OD	Core	CPU JTAG Test Data Output: Transfers serial test data out of the processor. TDO provides the serial output needed for JTAG specification support.
TMS	I CMOS	Core	CPU JTAG Test Mode Select: A JTAG specification support signal used by debug tools.
TRST_B	I CMOS	Core	CPU JTAG Test Reset: Asynchronously resets the Test Access Port (TAP) logic. TRST_B must be driven asserted (low) during CPU power on Reset.
IO_TDI	I CMOS	Core	JTAG Test Data In: TDI is used to serially shift data and instructions into the TAP.
IO_TDO	O CMOS_OD	Core	JTAG Test Data Out: TDO is used to serially shift data out of the device.
IO_TMS	I CMOS	Core	JTAG Test Mode Select: This signal is used to control the state of the TAP controller.
IO_TCK	I CMOS	Core	JTAG Test Clock: Provides the clock input for TAP controller.
IO_TRST_B	I CMOS	Core	JTAG Test Reset: Asynchronously resets the Test Access Port (TAP) logic. IO_TRST_B must be driven asserted (low) during power on Reset.



2.11 Miscellaneous Signals and Clocks

Table 15. Miscellaneous Signals and Clocks (Sheet 1 of 4)

Signal Name	Direction/ Type	Power Well	Description
Legacy (North Complex)			
CMREF	I Power	Core	Non-Strobe Signals' Reference Voltage for DMI : Externally set via passive voltage divider. 1 K Ω to Vccp. 1 K Ω to Vss.
GTLREF	I Power	Core	Strobe Signals' Reference Voltage for DMI : Externally set via passive voltage divider. 1 K Ω to Vccp. 1 K Ω to Vss.
COMP0[1:0]	I A	Core	RCOMP: Connected to high-precision resistors on the motherboard. Used for compensating DMI pull-up / pull-down impedances. COMP0[0] externally connects to 27.4 Ω 1% to Vss COMP0[1] externally connects to 54.9 Ω 1% to Vss
COMP1[1:0]	I A	Core	RCOMP: Connected to high-precision resistors on the motherboard. Used for compensating pull-up / pull-down impedances. COMP1[0] externally connects to 18.2 Ω 1% to Vss. COMP1[1] externally connects to 35.7 Ω 1% to Vss.
BPM_B[3:0]	I/O AGTL+	Core	Break/Perf Monitor: Various debug input and output functions.
NCTDO	O OD	Core	North TAP TDO: If the CPU TAP selects NCTAP mode, this pin is used as TDO output for the NCTAP. When NCTAP is not enabled, this pin is undef. When used as NCTAP TDO, requires external 56 Ω pullup to vccp (open drain).
NCTDI	I CMOS	Core	North Complex JTAG Test Data Input: Transfers serial test data into the processor. TDI provides the serial input needed for JTAG specification support.
NCTCK	I CMOS	Core	NCTAP TCLK or Low Yield Analysis (Negative): If the CPU TAP selects NCTAP mode, this pin is used as TCLK input for the NCTAP. Otherwise, this pin is used for testing of CPU's L2 cache. When used as NCTAP TCLK, requires external 56 Ω resistor to Vss
NCTMS	I CMOS	Core	NCTAP TMS or Low Yield Analysis (Positive): If the CPU TAP selects NCTAP mode, this pin is used as TMS input for the NCTAP. Otherwise, this pin is used for testing of CPU's L2 cache. When used as NCTAP TMS, requires external 56 Ω pullup to vccp.
PRDY_B	I/O AGTL+	Core	Probe Mode Ready: CPU is response to PREQ_B assertion. Indicates CPU is in probe mode. Input unused.
PREQ_B	I/O AGTL+	Core	Probe Mode Request: Assertion is a Request for the CPU to enter probe mode. CPU will response with PRDY_B assertion once it has entered. PREQ_B can be enabled to cause the CPU to break from C4 and C6.
GTLPPREF	I/O Power	Core	Voltage Reference for GPIO_B. 2/3 Vccp via external voltage divider: 1 k Ω to Vccp, 2 K Ω to VSS.
PROCHOT_B	I/O I:CMOS O:OD	Core	Processor Hot: CPU and optionally GMCH drives when it is throttling due to temperature. Can also be an input which causes the CPU and optional GMCH to throttle. External 22.1 \pm 1% Ω resistor in series with 60.4 \pm 1% Ω pull-up to Vccp.

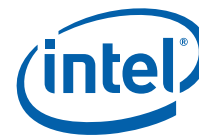

Table 15. Miscellaneous Signals and Clocks (Sheet 2 of 4)

Signal Name	Direction/ Type	Power Well	Description												
GPIO_B	I/O AGTL+	Core	General Purpose I/O / External Thermal Sensor: Same pin type as BPM[]. GPIO in this case is NOT the ACPI notion with lots of software configurability. Instead, this is essentially a spare pin that can be configured as an input or output which the microcontroller can respond to. It can also be configured as an external thermal sensor input.												
THERMTRIP_B	I/O OD	Core	Catastrophic Thermal Trip: The processor has reached an operating temperature that may damage the part. Platform should immediately cut power to the processor. THERMTRIP_B is not valid in M0, M2, and M3 PWRMODE states.												
GTLVREF	I A	Core	Voltage Reference for GPIO_B. 2/3 V _{ccp} via external voltage divider: 1 kΩ to V _{ccp} , 2 kΩ to vss.												
BSEL[0]/IERR	O CMOS	Core	<p>Reference Frequency Select / Internal Error: Depending on PowerMode[2:0]:</p> <table border="1"> <thead> <tr> <th>PowerMode[2:0]</th> <th>BSEL/IERR Select</th> </tr> </thead> <tbody> <tr> <td>M0</td> <td>INVALID</td> </tr> <tr> <td>M2</td> <td>INVALID -> BSEL</td> </tr> <tr> <td>M3, M1</td> <td>BSEL</td> </tr> <tr> <td>M5</td> <td>IERR</td> </tr> <tr> <td>M7, M6, M4</td> <td>Undef</td> </tr> </tbody> </table> <p>BSEL: Combined with BSEL[1] and BSEL[2], Selects External Reference Clock and DDR frequencies.</p> <p>000 - SKU_100 (DDR: 800) 001 - Reserved 010 - Reserved 011 - Reserved 100 - Reserved 101 - Reserved 110 - Reserved 110 - Reserved</p> <p>IERR: Internal Error indication (debug). Positively asserted. Asserted when CPU has had an internal error and may have unexpectedly stopped executing. Assertion of IERR is usually accompanied by a SHUTDOWN transaction internal to the processor which may result in assertion of NMI to the CPU. The processor will keep IERR asserted until the POWERMODE[] pins take the processor to reset.</p>	PowerMode[2:0]	BSEL/IERR Select	M0	INVALID	M2	INVALID -> BSEL	M3, M1	BSEL	M5	IERR	M7, M6, M4	Undef
PowerMode[2:0]	BSEL/IERR Select														
M0	INVALID														
M2	INVALID -> BSEL														
M3, M1	BSEL														
M5	IERR														
M7, M6, M4	Undef														
BSEL[2:1]	O CMOS	Core	Bus Frequency Select: Like BSEL[0]/IERR, this pin reflects the processor External Reference Clock and DDR2 frequency.												
PWRMODE[2:0]	I CMOS	Core	Power Mode: System management controller is expected to sequence the processor through various states using the POWERMODE[] pins to facilitate cold reset and warm reset.												
BCLKP/BLCKN	I Diff	Core	Reference Clock: Differential - 100 MHz.												
VID[6:0]	I/O CMOS	Core	Voltage ID: Indicates a desired voltage for either VCC or the VNN depending on the VIDEN pins. Resolution of 12.5 mV according to the Intel® MVP-6 spec.												



Table 15. Miscellaneous Signals and Clocks (Sheet 3 of 4)

Signal Name	Direction/ Type	Power Well	Description
VIDEN[1:0]	O CMOS	Core	Voltage ID Enable: Indicates which voltage is being specified on the VID pins: 00: VID is Invalid 01: VID = Vcc 10: VID = Vnn 11: Unused
TEST_B	I CMOS3.3	SUS	TEST: When asserted, component is put into TEST modes combinatorially.
RCOMP	I A	Core	Connect 249 Ω resistor to 1.05 V
IOCMREF	I/O A	Core	CMOS VREF 1 kΩ ± 1% pullup to V1P05_S and 1 kΩ ± 1% pull-down to GND
IOCOMP1[1:0]	I/O A	Core	IOCOMP1[0] externally connects to 18.2 Ω resistor 1% to Vss IOCOMP1[1] externally connects to 35.7 Ω resistor 1% to Vss
IOCOMP0[1:0]	I/O A	Core	IOCOMP0[0] externally connects to 27.4 Ω resistor 1% to Vss IOCOMP0[1] externally connects to 54.9 Ω resistor 1% to Vss
IO_RX_CVREF	I/O A	Core	CMOS VREF 510 Ω ± 5% pullup to V1P05_S and 1 kΩ ± 1% pull-down to GND
IO_RX_GVREF	I/O A	Core	GTL VREF 510 Ω ± 5% pullup to V1P05_S and 1 kΩ ± 1% pull-down to GND
DLIOCMREF	I Power	Core	Connect to VCCP 1 kΩ ± 1% pullup to V1P05_S and 2 kΩ ± 1% pull-down to GND
IOGTLREF	I/O A	Core	GTL VREF 1 kΩ ± 1% pullup to V1P05_S and 1 kΩ ± 1% pull-down to GND
DLIOGTLREF	I Power	Core	Connect to VCCP 1 kΩ ± 1% pullup to V1P05_S and 2 kΩ ± 1% pull-down to GND
VNSENSE VCC_VSSSENSE VCCSENSE	I A	Core	Voltage sense: Connects to Intel® MVP-6. Voltage Regulator must connect feedback lines for VCC, VSS and VNN to these pins on the package.
Thermal			
THRMDA	I A	Passive	Thermal Diode - Anode
THRMDC	O A	Passive	Thermal Diode - Cathode
CLK14	I CMOS3.3	Core	Oscillator Clock: This signal is used for 8254 timers and HPET. It runs at 14.31818 MHz. This clock stops (and should be low) during S3, S4, and S5 states. CLK14 must be accurate to within 500 ppm over 100 us (and longer periods) to meet HPET accuracy requirements.
SPKR	O CMOS3.3	Core	Speaker: The SPKR signal is the output of counter 2 and is internally ANDed with Port 61h bit 1 to provide Speaker Data Enable. This signal drives an external speaker driver device, which in turn drives the system speaker. Upon SLPMODE, its output state is 0.
SMI_B	I CMOS3.3	Core	System Management Interrupt: This signal is generated by the external system management controller.

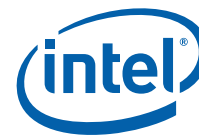

Table 15. Miscellaneous Signals and Clocks (Sheet 4 of 4)

Signal Name	Direction/ Type	Power Well	Description
THRM_B	I CMOS3.3	Core	Thermal Alarm: Generated by external hardware to generate SMI_B/SCI.
CRU/PLL			
HPLL_REFCLK_P HPLL_REFCLK_N	I CMOS	Core	Reference clock: Host PLL CLK Differential pair: 100 MHz.

2.12 General Purpose I/O

Table 16. General Purpose I/O Signals

Signal Name	Type	Power Well	Description
GPIO_SUS[8:0]	I/O CMOS3.3	SUS	General Purpose IO: These signals are powered off of the suspend well power plane within the processor. They are accessible during the S3 sleep state. GPIO_SUS[7] can be used to wake the system from Suspend-to-RAM while GPIO_SUS[1:4] can be used to wake the system from Suspend-to-RAM, provided LVDS is disabled on the platform. GPIO_SUS[7] is required to strap to 1 during platform boot up for Intel® Atom™ Processor E6xx Series B-1 Stepping.
GPIO[4:0]	I/O CMOS3.3	Core	General Purpose IO: These signals are powered off of the core well power plane within the processor.

2.13 Functional Straps

The following signals are used to configure certain processor features.

Table 17. Functional Straps (Sheet 1 of 2)

Signal Name	Strap Definition
GPIO_SUS[0]	STRAP_MEM_DEV_WIDTH: Defines the memory device width. 0: x16 devices 1: x8 devices
GPIO_SUS[6:5]	STRAP_MEM_DEV[1:0] = GPIO_SUS[6:5]. Defines the memory device densities connected. 11: 2 Gb 10: 1 Gb 01: 512 Mb 00: 256 Mb
GPIO_SUS[8]	STRAP_MEM_RANK: Defines the number of ranks enabled. 1: 1 Rank 0: 2 Rank



Table 17. Functional Straps (Sheet 2 of 2)

Signal Name	Strap Definition
GPIO[0]	STRAP_BOOT_FLASH: Defines whether TC boots from SPI or LPC 1: SPI 0: LPC Notes: Boot from LPC is not supported.
GPIO[3:2]	STRAP_CMC_BA[1:0] = GPIO[3:2]: CMC Base Address, defined the address the CMC will start fetching and executing code from 10 = 0xFFFE0000 11 = 0xFFFD0000 01 = 0xFFFC0000 00 = 0xFFFB0000
GPIO[4]	STRAP_LPCCLK_STRENGTH: LPC_CLKOUT[0] Buffer Strength Control. Select the drive strength of the LPC_CLKOUT[0] clock 0 = 1 load driver strength 1 = 2 load driver strength

2.14 Power and Ground Signals

This section provides power and ground signals for the Intel® Atom™ Processor E6xx Series.

Table 18. Power and Ground Signals (Sheet 1 of 2)

Signal Name	Nominal Voltage	Description
VCC	0.75 - 1.15 V	Processor Core Supply Voltage. Power supply is required for processor cycles.
VNN	0.75 - 0.9875 V	North Cluster Logic and Graphics Supply Voltage
VCCP	1.05 V	Needed for most bus accesses
VCCF	1.05 V	Can be connected to VCCP
VCCPQ	1.05 V	Can be connected to VCCP
VCCPDDR	1.05 V	DDR DLL and logic Supply Voltage. Required for memory bus accesses. Requires a separate rail with noise isolation.
VCCPA	1.05 V	JTAG, C6 SRAM, Fuse Supply Voltage. Needs to be on in Active or Standby. This rail is connected to the VCCP rail.
VCCQ	1.05 V	Connect to 1.05 V
LVD_VBG	1.25 V	LVDS Band Gap Supply Voltage. Needed for LVDS display
VCCA	1.5 V	Core PLL, core thermal sensor and sensor
VCCA180	1.8 V	LVDS Analog Supply Voltage. Needed for LVDS display. Requires a separate rail with noise isolation.
VCCD180	1.8 V	LVDS I/O Supply Voltage. Needed for LVDS display.
VCC180SR	AON	DDR2 Self Refresh Supply Voltage. Powered during Active, Standby, and Self-Refresh states.
VCC180	1.8 V	DDR2 I/O Supply Voltage. Required for memory bus accesses. Cannot be connected to VCC180SR during Standby or Self-Refresh states.
VCCD	1.05 V	Core supply voltage
VCCDSUS	1.05 V	Core suspend rail
VCCP33	3.3 V	Legacy I/O and SDVO supply voltage
VCCP33SUS	3.3 V	3.3 V suspend power supply
VCCPSUS	3.3 V	RTC suspend well voltage supply
VCC33RTC	3.3 V	RTC well voltage supply



Table 18. Power and Ground Signals (Sheet 2 of 2)

Signal Name	Nominal Voltage	Description
VCCD_DPL	1.05 V	DPLL dedicated supply
VCCA_PEG	1.05 V	Used by PCIe* and SDVO
VCCSFR_EXP	1.8 V	PCIe* superfilter regulator
VCCSFRDPLL	1.8 V	SDVO superfilter regulator
VCCSFRHPLL	1.8 V	HPLL superfilter regulator
VCCQHPLL	1.05 V	HPLL quiet supply
VCCFHV	1.05 V	Can be connected to VCCP
VMM	1.05 V	Connect to 1.05 V
VSS	0 V	Ground pin.
VCCSENSE, VCCDSENSE, VNNSENSE, VSSSEMNSE	N/A	Voltage sensing pins, voltage regulator must connect feedback lines for VCC, VCCD, VNN and VSS to these pins on the package. It appears that random VCC, VCCD, VNN and VSS bumps were picked for this, not adding to the total bump count.

§ §





3.0 Pin States

This chapter describes the states of each Intel® Atom™ Processor E6xx Series signal in and around reset. It also documents what signals have internal pull-up/pull-down/series termination resistors and their values.

3.1 Pin Reset States

Table 19. Reset State Definitions

Buffer Type	Buffer Description
High-Z	The processor places this output in a high-impedance state. For IOs, external drivers are not expected
Don't Care	The state of the input (driven or tri-stated) does not affect the processor. For IO, it is assumed the output buffer is in a high-impedance state.
V _{OH}	The processor drives this signal high
V _{OL}	The processor drives this signal low
VOX-known	The processor drives this signal to a level defined by internal function configuration
VOX-unknown	The processor drives this signal, but to an indeterminate value
V _{IH}	The processor expects/requires the signal to be driven high
V _{IL}	The processor expects/requires the signal to be driven low
pull-up	This signal is pulled high by a pull-up resistor (internal or external)
pull-down	This signal is pulled low by a pull-down resistor (internal or external)
VIX-unknown	The processor expects the signal to be driven by an external source, but the exact electrical level of that input is unknown
Running	The clock is toggling or the signal is transitioning because the function has not stopped
Off	The power plane for this signal is powered down. The processor does not drive outputs and inputs should not be driven to the processor.

3.2 System Memory Signals

Table 20. System Memory Signals (Sheet 1 of 2)

Signal Name	Direction	Reset	Post-Reset	S3	S4/S5
M_ODT[1:0]	O	High-Z	High-Z	High-Z	High-Z
M_CKP	O	High-Z	V _{OH}	High-Z	High-Z
M_CKN	O	High-Z	V _{OL}	High-Z	High-Z
M_CKE[1:0]	O	High-Z	V _{OL}	V _{OL}	V _{OL}
M_CSB[1:0]	O	High-Z	V _{OH}	High-Z	High-Z
M_RASB	O	High-Z	V _{OH}	High-Z	High-Z
M_CASB	O	High-Z	V _{OH}	High-Z	High-Z
M_WEB	O	High-Z	V _{OH}	High-Z	High-Z
M_BS[2:0]	O	High-Z	V _{OL}	High-Z	High-Z
M_MA[14:0]	O	High-Z	V _{OL}	High-Z	High-Z
M_DQ[31:0]	I/O	High-Z	High-Z	High-Z	High-Z
M_DQS[3:0]	I/O	High-Z	High-Z	High-Z	High-Z



Table 20. System Memory Signals (Sheet 2 of 2)

Signal Name	Direction	Reset	Post-Reset	S3	S4/S5
M_DM[3:0]	O	High-Z	High-Z	High-Z	High-Z
M_RCVENIN	I	VIX-unknown	VIX-unknown	VIX-unknown	VIX-unknown
M_RCVENOUT	O	High-Z	V _{OL}	High-Z	High-Z
M_RCOMPOUT	I	VIX-unknown	VIX-unknown	VIX-unknown	VIX-unknown

3.3 Integrated Display Interfaces

3.3.1 LVDS Signals

Table 21. LVDS Signals

Signal Name	Direction	Reset	Post-Reset	S3	S4/S5
LVD_DATAN_0	O	High-Z	High-Z	Off	Off
LVD_DATAN_1	O	High-Z	High-Z	Off	Off
LVD_DATAN_2	O	High-Z	High-Z	Off	Off
LVD_DATAN_3	O	High-Z	High-Z	Off	Off
LVD_DATAP_0	O	High-Z	High-Z	Off	Off
LVD_DATAP_1	O	High-Z	High-Z	Off	Off
LVD_DATAP_2	O	High-Z	High-Z	Off	Off
LVD_DATAP_3	O	High-Z	High-Z	Off	Off
LVD_CLKN	O	High-Z	High-Z	Off	Off
LVD_CLKP	O	High-Z	High-Z	Off	Off
LVD_IBG	I	High-Z	High-Z	Off	Off
LVD_VBG	I	High-Z	High-Z	Off	Off
LVD_VREFL	I	High-Z	High-Z	Off	Off
LVD_VREFH	I	High-Z	High-Z	Off	Off

3.3.2 Serial Digital Video Output (SDVO) Signals

Table 22. Serial Digital Video Output Signals (Sheet 1 of 2)

Signal Name	Direction	Reset	Post-Reset	S3	S4/S5
SDVO_REDP SDVO_REDN	O	V _{OL}	V _{OL}	Off	Off
SDVO_GREENP SDVO_GREENN	O	V _{OL}	V _{OL}	Off	Off
SDVO_BLUEP SDVO_BLUEN	O	V _{OL}	V _{OL}	Off	Off
SDVO_CLKP SDVO_CLKN	O	V _{OL}	V _{OL}	Off	Off
SDVO_INTN SDVO_INTN	I	VIX-unknown	VIX-unknown	Off	Off

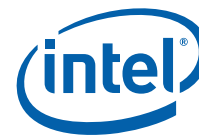

Table 22. Serial Digital Video Output Signals (Sheet 2 of 2)

Signal Name	Direction	Reset	Post-Reset	S3	S4/S5
SDVO_TVCLKINP SDVO_TVCLKINN	I	VIX-unknown	VIX-unknown	Off	Off
SDVO_STALLP SDVO_STALLN	I	VIX-unknown	VIX-unknown	Off	Off
SDVO_CTRLCLK	I/O	High-Z	High-Z	Off	Off
SDVO_CTRLDATA	I/O	High-Z	High-Z	Off	Off

3.4 PCI Express* Signals

Table 23. PCI Express* Signals

Signal Name	Direction	Reset	Post-Reset	S3	S4/S5
PCIE_PETp[3:0]	O	pull-up	VOL	Off	Off
PCIE_PETn[3:0]	O	VOH	VOH	Off	Off
PCIE_PERp[3:0]	I	VIX-unknown	VIX-unknown	Off	Off
PCIE_PERn[3:0]	I	VIX-unknown	VIX-unknown	Off	Off
PCIE_CLKINP PCIE_CLKINN	I	VIX-unknown	VIX-unknown	Off	Off
PCIE_ICOMPO	I/O	High-Z	High-Z	Off	Off
PCIE_ICOMPI	I/O	High-Z	High-Z	Off	Off
PCIE_RCOMPO	I/O	High-Z	High-Z	Off	Off
PCIE_RBIAIS	I/O	High-Z	High-Z	Off	Off

3.5 Intel® High Definition Audio^β Interface Signals

Table 24. Intel® High Definition Audio^β Interface Signals

Signal Name	Direction	Reset	Post-Reset	S3	S4/S5
HDA_RST_B	O	VOL	VOL	Off	Off
HDA_SYNC	O	High-Z	High-Z	Off	Off
HDA_CLK	O	VOL	VOL	Off	Off
HDA_SDO	O	High-Z	High-Z	Off	Off
HDA_SDI[1:0]	I	Don't Care	Don't Care	Off	Off
HDA_DOCKEN_B	O	VOH	VOH	Off	Off
HDA_DOCKRST_B	O	VOH	VOH	Off	Off



3.6 LPC Interface Signals

Table 25. LPC Interface Signals

Signal Name	Direction	Reset	Post-Reset	S3	S4/S5
LPC_AD[3:0]	I/O	High-Z	High-Z	Off	Off
LPC_FRAME_B	O	VOH	VOH	Off	Off
LPC_SERIRQ	I/O	High-Z	High-Z	Off	Off
LPC_CLKRUN_B	I/O	VOL	VOL	Off	Off
LPC_CLKOUT[2:0]	O	VOH	VOH	Off	Off

3.7 SMBus Interface Signals

Table 26. SMBus Interface Signals

Signal Name	Direction	Reset	Post-Reset	S3	S4/S5
SMB_DATA	I/O	High-Z	High-Z	Off	Off
SMB_CLK	I/O	High-Z	High-Z	Off	Off
SMB_ALERT_B	I	High-Z	High-Z	Off	Off

3.8 SPI Interface Signals

Table 27. SPI Interface Signals

Signal Name	Direction	Reset	Post-Reset	S3	S4/S5
SPI_MOSI	O	VOH	VOH	Off	Off
SPI_MISO	I	VIH	VIH	Off	Off
SPI_CS_B	I/O	VOH	VOH	Off	Off
SPI_SCK	O	VOL	VOL	Off	Off

3.9 Power Management Interface Signals

Table 28. Power Management Interface Signals (Sheet 1 of 2)

Signal Name	Direction	Reset	Post-Reset	S3	S4/S5
RESET_B	I	VIH	VIH	VIL	Off
PWROK	I	VIX-unknown	VIH	VIL	VIL
RSMRST_B	I	VIX-unknown	VIH	VIH	VIL
RTCST_B	I	VIX-unknown	VIH	VIH	VIH
SUSCLK	O	Running	Running	Running	Off
WAKE_B	I	VIX-unknown	VIX-unknown	VIX-unknown	Off
SLPMODE	O	VOL	VOL	VOL	Off
RSTWARN	I	VIH	VIH	VIH	Off

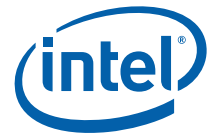

Table 28. Power Management Interface Signals (Sheet 2 of 2)

Signal Name	Direction	Reset	Post-Reset	S3	S4/S5
SLPRDY_B	O	VOH	VOH	VOH	Off
RSTRDY_B	O	VOH	VOH	VOH	Off
GPE_B	I	VIX-unknown	VIX-unknown	VIX-unknown	Off

3.10 Real Time Clock Interface Signals

Table 29. Real Time Clock Interface Signals

Signal Name	Direction	Reset	Post-Reset	S3	S4/S5
RTCX1	I	Running	Running	Running	Running
RTCX2	I	Running	Running	Running	Running

3.11 JTAG and Debug Interface

The JTAG interface is accessible only after PWROK is asserted.

Table 30. JTAG and Debug Interface Signals

Signal Name	Direction	Reset	Post-Reset	S3	S4/S5
TCK	I	VIL	VIL	Off	Off
TDI	I	VIH	VIH	Off	Off
TDO	O	High-Z	High-Z	Off	Off
TMS	I	VIH	VIH	Off	Off
TRST_B	I	VIX-known	VIH	Off	Off
IO_TDI	I	VIL	VIL	Off	Off
IO_TDO	O	High-Z	High-Z	Off	Off
IO_TMS	I	VIL	VIL	Off	Off
IO_TCK	I	VIL	VIL	Off	Off
IO_TRST_B	I	VIH	VIH	Off	Off

3.12 Miscellaneous Signals and Clocks

Table 31. Miscellaneous Signals and Clocks

Signal Name	Direction	Reset	Post-Reset	S3	S4/S5
Thermal					
CLK14	I	Running	Running	Off	Off
SPKR	O	VOL	VOL	Off	Off
SMI_B	I	VIX-unknown	VIX-unknown	Off	Off
THRM_B	I	VIX-unknown	VIX-unknown	Off	Off
CRU/PLL					
HPLL_REFCLK_P HPLL_REFCLK_N	I	Running	Running	Off	Off

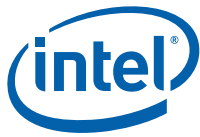

3.13 General Purpose I/O

Table 32. General Purpose I/O Signals

Signal Name	Direction	Reset	Post-Reset	S3	S4/S5
GPIO_SUS[8:0]	I/O	High-Z	High-Z	Unknown	Off
GPIO[4:0]	I/O	High-Z	High-Z	Off	Off

3.14 Integrated Termination Resistors

Table 33. Integrated Termination Resistors

Signal	Resistor Type	Nominal Value (Ω)	Tolerance
PCIE_PETP[3:0]	pull-down	50	20%
PCIE_PETN[3:0]	pull-down	50	20%
PCIE_PERP[3:0]	pull-down	50	20%
PCIE_PERN[3:0]	pull-down	50	20%
SDVO_REDP	pull-down	55	20%
SDVO_REDN	pull-down	55	20%
SDVO_GREENP	pull-down	55	20%
SDVO_GREENN	pull-down	55	20%
SDVO_BLUEP	pull-down	55	20%
SDVO_BLUEN	pull-down	55	20%
SDVO_TVCLKINP	pull-down	50	20%
SDVO_TVCLKINN	pull-down	50	20%
SDVO_INTP	pull-down	50	20%
SDVO_INTN	pull-down	50	20%
SDVO_CLKP	pull-down	55	20%
SDVO_CLKN	pull-down	55	20%
SDVO_STALLP	pull-down	50	20%
SDVO_STALLN	pull-down	50	20%

§ §

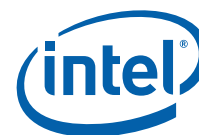

4.0 System Clock Domains

The Intel® Atom™ Processor E6xx Series contains many clock frequency domains to support its various interfaces.

Table 34 summarizes these domains.

Table 34. Intel® Atom™ Processor E6xx Series Clock Domains

Clock Domain	Signal Name	Frequency	Source	Usage
Processor	BCLKP/BCLKN	100 MHz	Main clock generator	Processor reference clock
Processor	HPLL_REFCLK_P HPLL_REFCLK_N	100 MHz	Main clock generator	Processor reference clock
CLK14	CLK14	14.31818 MHz	Main clock generator	Used by 8254 timers and HPET. It runs at 14.31818 MHz. This clock stops during S3, S4, and S5 states.
PCI Express*	PCIE_CLKINP PCIE_CLKINN	100 MHz	Main clock generator	PCI Express* ports
Display reference clock	SDVO_REFCLKP SDVO_REFCLKN	96 MHz	Main clock generator	Primary clock source for display clocks and Intel® High Definition Audio ^β
RTC	RTCX1 RTCX2	32.768 KHz	Crystal oscillator	RTC and power management. Always running
Derivative Clocks (These are clock domains that are fractional multiples of existing clock frequencies.)				
DDR2	M_CKP M_CKN	400 MHz	From Host PLL	Drives SDRAM ranks 0 and 1. Data Rate is 2x the clock rate.
LVDS	LVD_CLKP LVD_CLKN	20 MHz - 80 MHz	From Display PLL	LVDS display clock outputs
SDVO	SDVO_CLKP SDVO_CLKN	100 MHz - 160 MHz	From Display PLL	SDVO display clock outputs
LPC	LPC_CLKOUT[2:0]	Up to 33 MHz	From CRU	Supplied for external devices requiring PCICLK
Intel® HD Audio ^β	HDA_CLK	24 MHz	From CRU	Drives external codecs
SMBus	SMB_CLK	Up to 1 MHz	From CRU	Drives external SMBus device
SPI	SPI_SCLK	20/33 MHz	From CRU	Drives external SPI flash device

§ §



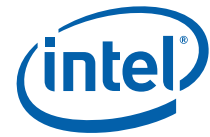

5.0 Register and Memory Mapping

This chapter describes the I/O and memory map settings for the Intel® Atom™ Processor E6xx Series in the MCP.

5.1 Address Map

The Intel® Atom™ Processor E6xx Series contains registers that are located in the processor's memory and I/O space. It also contains sets of PCI configuration registers that are located in a separate configuration space.

Table 35. Register Access Types and Definitions

Access Type	Meaning	Description
RO	Read Only	In some cases, if a register is read only, writes to this register location have no effect. However, in other cases, two separate registers are located at the same location where a read accesses one of the registers and a write accesses the other register. See the I/O and memory map tables for details.
WO	Write Only	In some cases, if a register is write only, reads to this register location have no effect. However, in other cases, two separate registers are located at the same location where a read accesses one of the registers and a write accesses the other register. See the I/O and memory map tables for details.
R/W	Read/Write	A register with this attribute can be read and written.
R/WC	Read/Write Clear	A register bit with this attribute can be read and written. However, a write of 1 clears (sets to 0) the corresponding bit and a write of 0 has no effect.
R/WO	Read/Write-Once	A register bit with this attribute can be written only once after power up. After the first write, the bit becomes read only.
R/WLO	Read/Write, Lock-Once	A register bit with this attribute can be written to the non-locked value multiple times, but to the locked value only once. After the locked value has been written, the bit becomes read only.
Default	Default	When the processor is reset, it sets its registers to predetermined default states. The default state represents the minimum functionality feature set required to successfully bring up the system. Hence, it does not represent the optimal system configuration. It is the responsibility of the system initialization software to determine configuration, operating parameters, and optional system features that are applicable, and to program the processor registers accordingly.

5.2 Introduction

The Intel® Atom™ Processor E6xx Series contains two sets of software accessible registers accessed via the host processor I/O address space: Control registers and internal configuration registers.

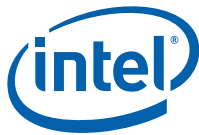

- Control registers are I/O mapped into the processor I/O space that controls access to PCI and PCI Express* configuration space.
- Internal configuration registers residing within the processor are partitioned into nine logical device register sets, one for each PCI device listed in [Table 39](#). (These are “logical” devices because they reside within a single physical device.)

The processor’s internal registers (I/O Mapped, Configuration and PCI Express* Extended Configuration registers) are accessible by the host processor. The registers that reside within the lower 256 bytes of each device can be accessed as Byte, Word (16-bit), or DWord (32-bit) quantities, with the exception of CONFIG_ADDRESS, which can only be accessed as a DWord. All multi-byte numeric fields use little-endian ordering (i.e., lower addresses contain the least significant parts of the field). Registers which reside in bytes 256 through 4095 of each device may only be accessed using memory mapped transactions in DWord (32-bit) quantities. Some of the registers described in this section contain reserved bits. These bits are labeled Reserved. Software must deal correctly with fields that are reserved. On reads, software must use appropriate masks to extract the defined bits and not rely on reserved bits being any particular value. On writes, software must ensure that the values of reserved bit positions are preserved. That is, the values of reserved bit positions must first be read, merged with the new values for other bit positions and then written back.

Note: Software does not need to perform read, merge, and write operations for the configuration address register.

In addition to reserved bits within a register, the processor contains address locations in the configuration space of the Host Bridge entity that are marked either Reserved or Intel Reserved. The processor responds to accesses to Reserved address locations by completing the host cycle. When a Reserved register location is read, a zero value is returned. (Reserved registers can be 8, 16, or 32 bits in size). Writes to Reserved registers have no effect on the processor. Registers that are marked as Intel Reserved must not be modified by system software. Writes to Intel Reserved registers may cause system failure. Reads from Intel Reserved registers may return a non-zero value.

Upon a Cold Reset, the processor sets all configuration registers to predetermined default states. Some default register values are determined by external strapping options. The default state represents the minimum functionality feature set required to successfully bring up the system; it does not represent the optimal system configuration. It is the responsibility of the system initialization software (usually BIOS) to properly determine the DRAM configurations and to program the system memory accordingly.

5.3 System Memory Map

The Intel® Atom™ Processor E6xx Series supports up to 2 GB of physical DDR2 memory space and 64 kB + 3 of addressable I/O space. There is a programmable memory address space under the 1 MB region which is divided into regions that can be individually controlled with programmable attributes such as Disable, Read/Write, Write Only, or Read Only. This section describes how the memory space is partitioned and how those partitions are used.

Top of Memory (TOM) is the highest address of physical memory actually installed in the system. A TOM of greater than 2 GB is not supported. Memory addresses above 2 GB will be routed to internal controllers or external I/O devices.

[Figure 3](#) represents the system memory address map in a simplified form.

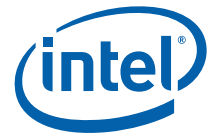

Figure 3. System Address Map

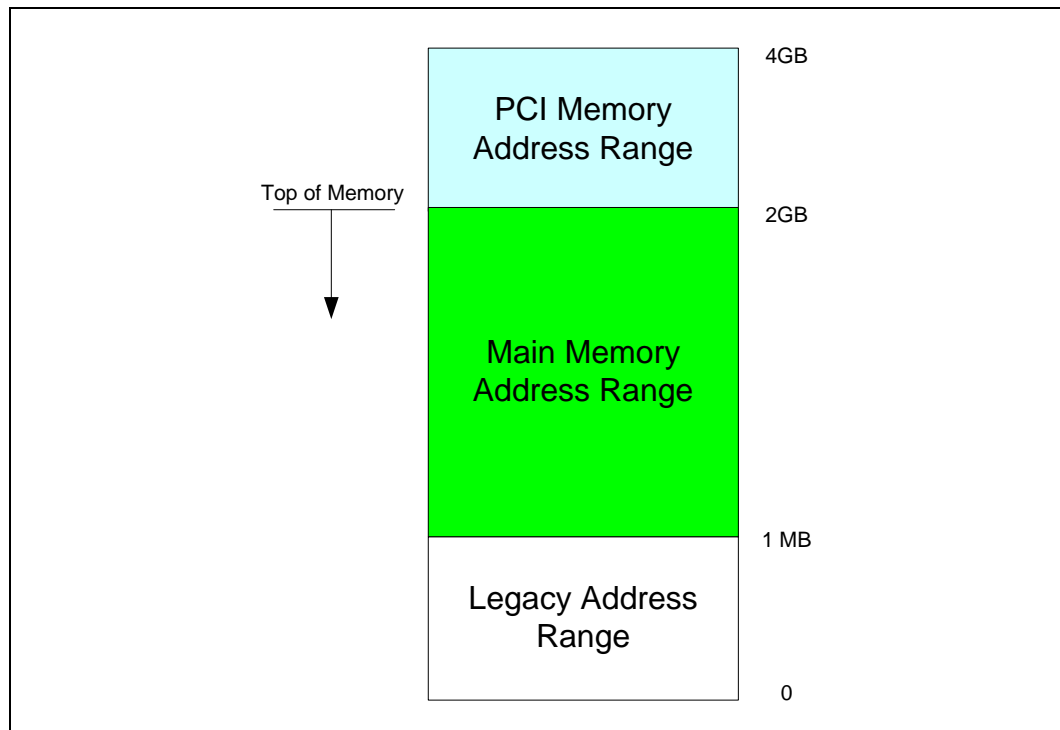

Table 36. Memory Map (Sheet 1 of 2)

Device	Start Address	End Address	Comments
Legacy Address Range (0 to 1 MB)			
DOS_DRAM	00000000	0009FFFF	
Legacy Video (VGA)	000A0000	000DFFFF	
PAM	000E0000	000EFFFF	
PAM	000F0000	000FFFFFFF	
BIOS (LPC)	000F0000	000FFFFFFF	
LPC	000E0000	000FFFFFFF	Provided PAM is not enabled
Main Memory (1 MB to TOM)			
TSEG	Variable	Variable	
Graphics	Variable	Variable	
PCI Configuration Space (2 GB to 4 GB)			
IOxAPIC	FEC00000	FEC00040	
HPET	FED00000h	FED003FFh	High Performance Event Timer
Intel® Trusted Platform Module [®] 1.2	FED40000	FED4BFFF	LPC



Table 36. Memory Map (Sheet 2 of 2)

Device	Start Address	End Address	Comments
High BIOS	FFC00000	FFFFFFF	The Chipset Microcode (CMC) base address lives within the LPC space and consumes 64 kB of space. Make sure to avoid using the same starting address for other LPC devices in the system.
Configurable Main Memory Configuration Spaces			
PCI Express* Port 0	Anywhere in 32-bit range		Configured via D23:F0:MB/ML
PCI Express* Port 0 (prefetchable)	Anywhere in 32-bit range		Configured via D23:F0:PMB/PML
PCI Express* Port 1	Anywhere in 32-bit range		Configured via D24:F0:MB/ML
PCI Express* Port 1 (prefetchable)	Anywhere in 32-bit range		Configured via D24:F0:PMB/PML
PCI Express* Port 2	Anywhere in 32-bit range		Configured via D25:F0:MB/ML
PCI Express* Port 2 (prefetchable)	Anywhere in 32-bit range		Configured via D25:F0:PMB/PML
PCI Express* Port 3	Anywhere in 32-bit range		Configured via D26:F0:MB/ML
PCI Express* Port 3 (prefetchable)	Anywhere in 32-bit range		Configured via D26:F0:PMB/PML
Root Complex Base Register	16 kB anywhere in the 32 bit range		Configured via D31:F0:RCBA
Intel® High Definition Audio ^β	16 kB anywhere in 32-bit range		Configured via D27:F0:LBAR/UBAR
Display	512 kB anywhere in 32-bit range		Configured via D3:F0:MMBAR

Note: All accesses to addresses within the main memory range will be forwarded to the DRAM unless they fall into one of the optional ranges specified in this section.

Note: Boot with the LPC interface is not validated.

5.3.1 I/O Map

The I/O map is divided into separate types. Fixed ranges cannot be moved, but some may be disabled, while variable ranges can be moved.

5.3.1.1 Fixed I/O Address Range

Table 37 shows the fixed I/O decode ranges from the CPU perspective.

Table 37. Fixed I/O Range Decoded by the Processor (Sheet 1 of 2)

I/O Address	Read Target	Write Target	Can be disabled?
20h-3Ch	8259 Master	8259 Master	No
40h-53h	8254	8254	No
61h-67h	NMI Controller	NMI Controller	No
70h	None	NMI and RTC	No
71h	RTC	RTC	No
72h	RTC	NMI and RTC	Yes, with 73h
73h	RTC	RTC	Yes, with 72h

**Table 37. Fixed I/O Range Decoded by the Processor (Sheet 2 of 2)**

I/O Address	Read Target	Write Target	Can be disabled?
74h	RTC	NMI and RTC	No
75h	RTC	RTC	No
76h	RTC	NMI and RTC	No
77h	RTC	RTC	No
84h-86h	Internal	Internal	No
88h	Internal	Internal	No
8Ch-8Eh	Internal	Internal	No
A0h-ACh	8259 Slave	8259 Slave	No
B0h	8259 Slave	8259 Slave	No
B2h-B3h	Power Management	Power Management	No
B4h-BCh	8259 Slave	8259 Slave	No
3B0h-3BBh	VGA	VGA	Yes
3C0h-3DFh	VGA	VGA	Yes
CF8h, CFCh	Internal	Internal	No
CF9h	Reset Generator	Reset Generator	No

5.3.1.2 Variable I/O Address Range

Table 38 shows the variable I/O decode ranges. They are set using base address registers (BARs) or other configuration bits in various configuration spaces. The PnP software (PCI or ACPI) can use their configuration mechanisms to set and adjust these values.

Warning: The variable I/O ranges should not be set to conflict with the fixed I/O ranges. There will be unpredictable results if the configuration software allows conflicts to occur. The Intel® Atom™ Processor E6xx Series does not check for conflicts.

Table 38. Variable I/O Range Decoded by the Processor

Range Name	Mappable	Size (bytes)	Target
ACPI P_BLK	Anywhere in 64k I/O space	16	Power Management
SMBus	Anywhere in 64k I/O space	32	SMB Unit
GPIO	Anywhere in 64k I/O space	64	GPIO

5.3.2 PCI Devices and Functions

The Intel® Atom™ Processor E6xx Series incorporates a variety of PCI devices and functions, as shown in Table 39.

Table 39. PCI Devices and Functions (Sheet 1 of 2)

Bus: Device: Function #	Functional Description
Bus 0: Device 0: Function 0	Host Bridge
Bus 0: Device 2: Function 0	Integrated Graphics and Video Device
Bus 0: Device 3: Function 0	SDVO Display Unit
Bus 0: Device 23: Function 0	PCI Express* Port 0
Bus 0: Device 24: Function 0	PCI Express* Port 1

Table 39. PCI Devices and Functions (Sheet 2 of 2)

Bus: Device: Function #	Functional Description
Bus 0: Device 25: Function 0	PCI Express* Port 2
Bus 0: Device 26: Function 0	PCI Express* Port 3
Bus 0: Device 27: Function 0	Intel® High Definition Audio ^β Controller
Bus 0: Device 31: Function 0	LPC Interface

Figure 4. PCI Devices

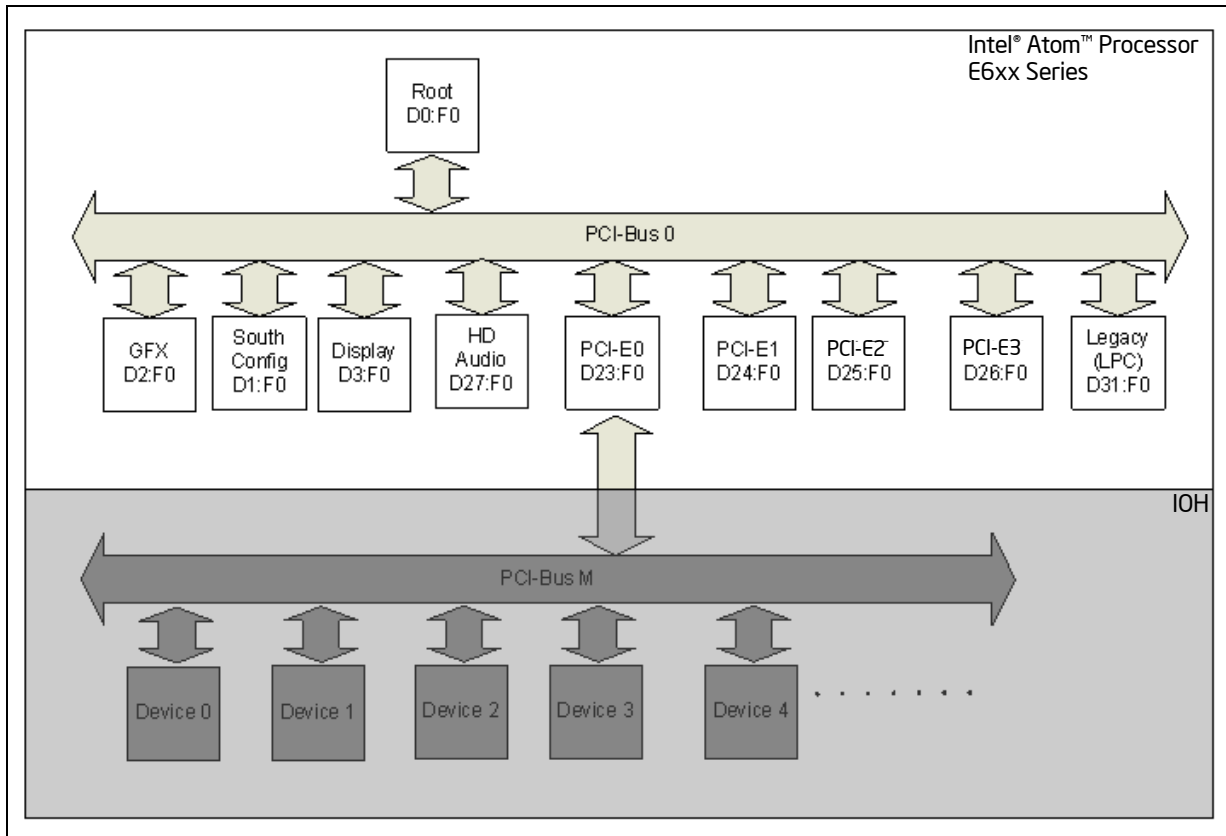

5.4 Register Access Method

The registers and the connected devices can be accessed by the host through either a direct register access method or an indirect register access method.

5.4.1 Direct Register Access

5.4.1.1 Hard Coded IO Access

The Intel® Atom™ Processor E6xx Series decodes the 16-bit address for a PORT IN and/or PORT OUT from the CPU and directly accesses the register. These addresses are unmovable.

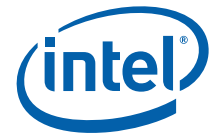

5.4.1.2 IO BAR

The Intel® Atom™ Processor E6xx Series uses a programmable base address (BAR) to set a range of IO locations that it will use to decode PORT IN and/or PORT OUT from the CPU and directly accesses a register(s). The BAR register is generally located in the PCI configuration space and is programmable by the BIOS/OS.

5.4.1.3 Hard-Coded Memory Access

The Intel® Atom™ Processor E6xx Series decodes CPU memory reads/writes to memory locations not covered by system DRAM. These locations are unmovable.

5.4.1.4 Memory BAR

The Intel® Atom™ Processor E6xx Series uses a programmable base address (BAR) to set a range of memory locations that it will use to decode CPU memory reads/writes (to memory locations not covered by system DRAM) and directly accesses a register(s). The BAR register is generally located in PCI configuration space and is programmable by the BIOS/OS.

5.4.2 Indirect Register Access

5.4.2.1 PCI Config Space

Each PCI device (as defined in [Table 39](#)) has a standard PCI header defined consisting of 256 bytes. Access to PCI configuration space is through two methods: I/O indexed and memory mapped.

5.4.2.1.1 PCI Configuration Access - I/O Indexed Scheme

Accesses to configuration space may be performed via the hard-coded DWORD I/O ports CF8h and CFCh. In this mode, software uses CF8h as an index register, indicating which configuration space to access, and CFCh as the data register. Accesses to CF8h will be captured internally and stored. Upon a read or write access to CFCh, a configuration cycle will be generated with the address specified from the data stored in CF8h. The format of the address is as shown in [Table 40](#).

Table 40. PCI Configuration PORT CF8h Mapping

Field	Configuration Cycle Bits	I/O CF8h Cycle Bits
Bus Number	31:24	23:16
Device Number	23:19	15:11
Function Number	18:16	10:08
Register Number	07:02	07:02

Note: Bit 31 of offset CF8h must be set for a configuration cycle to be generated.

5.4.2.1.2 PCI Config Access - Memory Mapped Scheme

A flat, 256 MB memory space may also be allocated to perform configuration transactions. This is enabled through a special register on the message network. This sets a 4-bit base which is compared against bits 31:28 of the incoming memory address. If these four bits match, the cycle is turned into a configuration cycle with the fields shown in [Table 41](#).

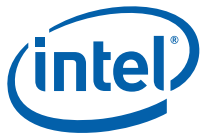

Table 41. PCI Configuration Memory Bar Mapping

Field	Configuration Cycle Bits	Memory Cycle Bits
Bus Number	31:24	27:20
Device Number	23:19	19:15
Function Number	18:16	14:12
Register Number	11:02	11:02

5.5 Bridging and Configuration

This describes all registers and base functionality that is related to chipset configuration and not a specific interface. It contains the root complex register block. This block is mapped into memory space, using RCBA. Accesses in this space are limited to 32-bit quantities. Burst accesses are not allowed.

5.5.1 Root Complex Topology Capability Structure

The following registers follow the PCI Express* capability list structure as defined in the PCI Express* specification, to indicate the capabilities of the component.

Table 42. PCI Express* Capability List Structure

Start	End	Symbol	Register Name
0000	0003	RCTCL	Root Complex Topology Capability List
0004	0007	ESD	Element Self Description
0010	0013	HDD	Intel® High Definition Audio ^β Description (port 15)
0014	0017	Reserved	Reserved
0018	008F	HDBA	Intel® High Definition Audio ^β Base Address (port 15)

5.5.1.1 Offset 0000h: RCTCL – Root Complex Topology Capabilities List

Table 43. 0000h: RCTCL – Root Complex Topology Capabilities List

Size: 32 bit		Default:		Power Well:
Access		Memory Mapped IO	BAR: RCBA	Offset: 0000h - 0003h
Bit Range	Default	Access	Acronym	Description
31 : 20	000h	RO	NEXT	Next Capability: Indicates the next item in the list
19 : 16	1h	RO	CV	Capability Version: Indicates the version of the capability structure
15 : 00	0005h	RO	CID	Capability ID: Indicates that this is a PCI Express* link capability section of an RCRB



5.5.1.2 Offset 0004h: ESD – Element Self Description

Table 44. 0004h: ESD – Element Self Description

Size: 32 bit		Default:		Power Well:
Access		Memory Mapped IO		BAR: RCBA
Bit Range		Default	Access	Acronym
		Description		
31 : 24	00h	RO	PN	Port Number: A value of 0 indicates the egress port.
23 : 16	00h	RWO	CID	Component ID: This indicates the component ID assigned to this element by software. This is written once by the platform BIOS and is locked until a platform reset.
15 : 08	01h	RO	NLE	Number of Link Entries: Indicates that one link entry is described by this RCRB
07 : 04	0	RO	RSVD	Reserved
03 : 00	2h	RO	ET	Element Type: Indicates that the element type is a root complex internal link

5.5.1.3 Offset 0010h: HDD – Intel® High Definition Audio^β Description

Table 45. 0010h: HDD – Intel® High Definition Audio^β Description

Size: 32 bit		Default:		Power Well:
Access		Memory Mapped IO		BAR: RCBA
Bit Range		Default	Access	Acronym
		Description		
31 : 24	Fh	RO	PN	Target Port Number: Indicates that the target port number is 15 (Intel® HD Audio ^β)
23 : 16	Variable	RO	TCID	Target Component ID: This field returns the value of the ESD.CID field programmed by the platform BIOS, since the root port is in the same component as the RCRB.
15 : 02	0	RO	RSVD	Reserved
01	1	RO	LT	Link Type: Indicates that the link points to a root port
00	1	RO	LV	Link Valid: Link is always valid.

5.5.1.4 Offset 0018h: HDBA – Intel® High Definition Audio^β Base Address

Table 46. 0018h: HDBA – Intel® High Definition Audio^β Base Address (Sheet 1 of 2)

Size: 64 bit		Default:		Power Well:
Access		Memory Mapped IO		BAR: RCBA
Bit Range		Default	Access	Acronym
		Description		
63 : 32	0h	RO	CBAU	Config Space Base Address Upper: Reserved
31 : 28	0h	RO	CBAL	Config Space Base Address Lower: Reserved
27 : 20	0h	RO	BN	Bus Number: Indicates Intel® HD Audio ^β is on bus #0
19 : 15	1Bh	RO	DN	Device Number: Indicates Intel® HD Audio ^β is in device #27
14 : 12	0h	RO	FN	Function Number: Indicates Intel® HD Audio ^β is in function #0



Table 46. 0018h: HDBA – Intel® High Definition Audio^β Base Address (Sheet 2 of 2)

Size: 64 bit		Default:		Power Well:
Access		Memory Mapped IO	BAR: RCBA	Offset: 0018h - 008Fh
Bit Range	Default	Access	Acronym	Description
11 : 00	0	RO	RSVD	Reserved

5.5.2 Interrupt Pin Configuration

The following registers tell each device which interrupt pin to report in the IPIN register of their configuration space, as shown in Table 47.

Table 47. Interrupt Pin Configuration

Bits	Pin	Bits	Pin
0h	No Interrupt	1h	INTA_B
2h	INTB_B	3h	INTC_B
4h	INTD_B	5h-Fh	Reserved

5.5.2.1 Offset 3100h: D31IP – Device 31 Interrupt Pin

Table 48. 3100h: D31IP – Device 31 Interrupt Pin

Size: 32 bit		Default:		Power Well:
Access		Memory Mapped IO	BAR: RCBA	Offset: 3100h
Bit Range	Default	Access	Acronym	Description
31 : 04	0	RO	RSVD	Reserved
03 : 00	0h	RO	LIP	LPC Bridge Pin: The LPC bridge does not generate an interrupt.

5.5.2.2 Offset 3110h: D27IP – Device 27 Interrupt Pin

Table 49. 3110h: D27IP – Device 27 Interrupt Pin

Size: 32 bit		Default:		Power Well:
Access		Memory Mapped IO	BAR: RCBA	Offset: 3110h
Bit Range	Default	Access	Acronym	Description
31 : 04	0	RO	RSVD	Reserved
03 : 00	1h	RW	HDAIP	Intel® HD Audio^β Pin: Indicates which pin the Intel® HD Audio ^β controller uses

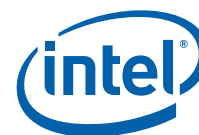

5.5.2.3 Offset 3118h: D02IP – Device 2 Interrupt Pin

Table 50. 3118h: D02IP – Device 2 Interrupt Pin

Size: 32 bit		Default:		Power Well:
Access		Memory Mapped IO	BAR: RCBA	Offset: 3118h
Bit Range	Default	Access	Acronym	Description
31 : 04	0	RO	RSVD	Reserved
03 : 00	1h	RW	GP	Graphics Pin: Indicates which pin the graphics controller uses for interrupts

5.5.2.4 Offset 3120h: D26IP – Device 26 Interrupt Pin

Table 51. 3120h: D26IP – Device 26 Interrupt Pin

Size: 32 bit		Default:		Power Well:
Access		Memory Mapped IO	BAR: RCBA	Offset: 3120h
Bit Range	Default	Access	Acronym	Description
31 : 04	0	RO	RSVD	Reserved
03 : 00	1h	RW	P4IP	PCI Express* #4 Pin: Indicates which pin PCI Express* port #3 uses

5.5.2.5 Offset 3124h: D25IP – Device 25 Interrupt Pin

Table 52. 3124h: D25IP – Device 25 Interrupt Pin

Size: 32 bit		Default:		Power Well:
Access		Memory Mapped IO	BAR: RCBA	Offset: 3124h
Bit Range	Default	Access	Acronym	Description
31 : 04	0	RO	RSVD	Reserved
03 : 00	1h	RW	P3IP	PCI Express* #3 Pin: Indicates which pin PCI Express* port #2 uses

5.5.2.6 Offset 3128h: D24IP – Device 24 Interrupt Pin

Table 53. 3128h: D24IP – Device 24 Interrupt Pin

Size: 32 bit		Default:		Power Well:
Access		Memory Mapped IO	BAR: RCBA	Offset: 3128h
Bit Range	Default	Access	Acronym	Description
31 : 04	0	RO	RSVD	Reserved
03 : 00	1h	RW	P2IP	PCI Express* #2 Pin: Indicates which pin PCI Express* port #1 uses



5.5.2.7 Offset 312Ch: D23IP – Device 23 Interrupt Pin

Table 54. 312Ch: D23IP – Device 23 Interrupt Pin

Size: 32 bit		Default:		Power Well:
Access		Memory Mapped IO	BAR: RCBA	Offset: 312Ch
Bit Range	Default	Access	Acronym	Description
31 : 04	0	RO	RSVD	Reserved
03 : 00	1h	RW	P1IP	PCI Express* #1 Pin: Indicates which pin PCI Express* port #0 uses

5.5.2.8 Offset 3130h: D03IP – Device 3 Interrupt Pin

Table 55. 3130h: D03IP – Device 3 Interrupt Pin

Size: 32 bit		Default:		Power Well:
Access		Memory Mapped IO	BAR: RCBA	Offset: 3130h
Bit Range	Default	Access	Acronym	Description
31 : 04	0	RO	RSVD	Reserved
03 : 00	1h	RW	DP	Display Pin: Indicates which pin the graphics controller uses for interrupts

5.5.3 Interrupt Route Configuration

Indicates which interrupt routing is connected to the INTA/B/C/D pins reported in the “DxIP” register fields. This will be the internal routing; the device interrupt is connected to the interrupt controller..

Table 56. Interrupt Route Configuration

Bits	Pin	Bits	Pin
0h	PIRQA_B	4h	PIRQE_B
1h	PIRQB_B	5h	PIRQF_B
2h	PIRQC_B	6h	PIRQG_B
3h	PIRQD_B	7h	PIRQH_B
8h-Fh	Reserved		

5.5.3.1 Offset 3140h: D31IR – Device 31 Interrupt Route

Table 57. 3140h: D31IR – Device 31 Interrupt Route (Sheet 1 of 2)

Size: 16 bit		Default:		Power Well:
Access		Memory Mapped IO	BAR: RCBA	Offset: 3140h
Bit Range	Default	Access	Acronym	Description
15 : 12	3h	RW	IDR	Interrupt D Pin Route: Indicates which routing is used for INTD_B of device 31

**Table 57. 3140h: D31IR – Device 31 Interrupt Route (Sheet 2 of 2)**

Size: 16 bit		Default:		Power Well:
Access		Memory Mapped IO	BAR: RCBA	Offset: 3140h
Bit Range	Default	Access	Acronym	Description
11 : 08	2h	RW	ICR	Interrupt C Pin Route: Indicates which routing is used for INTC_B of device 31
07 : 04	1h	RW	IBR	Interrupt B Pin Route: Indicates which routing is used for INTB_B of device 31
03 : 00	0h	RW	IAR	Interrupt A Pin Route: Indicates which routing is used for INTA_B of device 31

5.5.3.2 Offset 3148h: D27IR – Device 27 Interrupt Route**Table 58. 3148h: D27IR – Device 27 Interrupt Route**

Size: 16 bit		Default:		Power Well:
Access		Memory Mapped IO	BAR: RCBA	Offset: 3148h
Bit Range	Default	Access	Acronym	Description
15 : 12	3h	RW	IDR	Interrupt D Pin Route: Indicates which routing is used for INTD_B of device 27
11 : 08	2h	RW	ICR	Interrupt C Pin Route: Indicates which routing is used for INTC_B of device 27
07 : 04	1h	RW	IBR	Interrupt B Pin Route: Indicates which routing is used for INTB_B of device 27
03 : 00	0h	RW	IAR	Interrupt A Pin Route: Indicates which routing is used for INTA_B of device 27

5.5.3.3 Offset 314Ah: D26IR – Device 26 Interrupt Route**Table 59. 314Ah: D26IR – Device 26 Interrupt Route**

Size: 16 bit		Default:		Power Well:
Access		Memory Mapped IO	BAR: RCBA	Offset: 314Ah
Bit Range	Default	Access	Acronym	Description
15 : 12	3h	RW	IDR	Interrupt D Pin Route: Indicates which routing is used for INTD_B of device 26
11 : 08	2h	RW	ICR	Interrupt C Pin Route: Indicates which routing is used for INTC_B of device 26
07 : 04	1h	RW	IBR	Interrupt B Pin Route: Indicates which routing is used for INTB_B of device 26
03 : 00	0h	RW	IAR	Interrupt A Pin Route: Indicates which routing is used for INTA_B of device 26

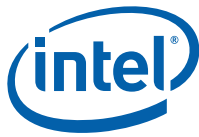

5.5.3.4 Offset 314Ch: D25IR – Device 25 Interrupt Route

Table 60. 314Ch: D25IR – Device 25 Interrupt Route

Size: 16 bit		Default:		Power Well:
Access		Memory Mapped IO	BAR: RCBA	Offset: 314Ch
Bit Range	Default	Access	Acronym	Description
15 : 12	3h	RW	IDR	Interrupt D Pin Route: Indicates which routing is used for INTD_B of device 25
11 : 08	2h	RW	ICR	Interrupt C Pin Route: Indicates which routing is used for INTC_B of device 25
07 : 04	1h	RW	IBR	Interrupt B Pin Route: Indicates which routing is used for INTB_B of device 25
03 : 00	0h	RW	IAR	Interrupt A Pin Route: Indicates which routing is used for INTA_B of device 25

5.5.3.5 Offset 314Eh: D24IR – Device 24 Interrupt Route

Table 61. 314Eh: D24IR – Device 24 Interrupt Route

Size: 16 bit		Default:		Power Well:
Access		Memory Mapped IO	BAR: RCBA	Offset: 314Eh
Bit Range	Default	Access	Acronym	Description
15 : 12	3h	RW	IDR	Interrupt D Pin Route: Indicates which routing is used for INTD_B of device 24
11 : 08	2h	RW	ICR	Interrupt C Pin Route: Indicates which routing is used for INTC_B of device 24
07 : 04	1h	RW	IBR	Interrupt B Pin Route: Indicates which routing is used for INTB_B of device 24
03 : 00	0h	RW	IAR	Interrupt A Pin Route: Indicates which routing is used for INTA_B of device 24

5.5.3.6 Offset 3150h: D23IR – Device 23 Interrupt Route

Table 62. 3150h: D23IR – Device 23 Interrupt Route

Size: 16 bit		Default:		Power Well:
Access		Memory Mapped IO	BAR: RCBA	Offset: 3150h
Bit Range	Default	Access	Acronym	Description
15 : 12	3h	RW	IDR	Interrupt D Pin Route: Indicates which routing is used for INTD_B of device 23
11 : 08	2h	RW	ICR	Interrupt C Pin Route: Indicates which routing is used for INTC_B of device 23
07 : 04	1h	RW	IBR	Interrupt B Pin Route: Indicates which routing is used for INTB_B of device 23
03 : 00	0h	RW	IAR	Interrupt A Pin Route: Indicates which routing is used for INTA_B of device 23

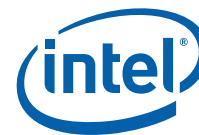

5.5.3.7 Offset 3160h: D02IR – Device 2 Interrupt Route

Table 63. 3160h: D02IR – Device 2 Interrupt Route

Size: 16 bit		Default:		Power Well:
Access		Memory Mapped IO		BAR: RCBA
Access				Offset: 3160h
Bit Range	Default	Access	Acronym	Description
15 : 12	3h	RW	IDR	Interrupt D Pin Route: Indicates which routing is used for INTD_B of device 2
11 : 08	2h	RW	ICR	Interrupt C Pin Route: Indicates which routing is used for INTC_B of device 2
07 : 04	1h	RW	IBR	Interrupt B Pin Route: Indicates which routing is used for INTB_B of device 2
03 : 00	0h	RW	IAR	Interrupt A Pin Route: Indicates which routing is used for INTA_B of device 2

5.5.3.8 Offset 3162h: D03IR – Device 3 Interrupt Route

Table 64. 3162h: D03IR – Device 3 Interrupt Route

Size: 16 bit		Default:		Power Well:
Access		Memory Mapped IO		BAR: RCBA
Access				Offset: 3162h
Bit Range	Default	Access	Acronym	Description
15 : 12	3h	RW	IDR	Interrupt D Pin Route: Indicates which routing is used for INTD_B of device 3
11 : 08	2h	RW	ICR	Interrupt C Pin Route: Indicates which routing is used for INTC_B of device 3
07 : 04	1h	RW	IBR	Interrupt B Pin Route: Indicates which routing is used for INTB_B of device 3
03 : 00	0h	RW	IAR	Interrupt A Pin Route: Indicates which routing is used for INTA_B of device 3

5.5.4 General Configuration

5.5.4.1 Offset 3400h: RC – RTC Configuration

Table 65. 3400h: RC – RTC Configuration (Sheet 1 of 2)

Size: 32 bit		Default:		Power Well:
Access		Memory Mapped IO		BAR: RCBA
Access				Offset: 3400h
Bit Range	Default	Access	Acronym	Description
31 : 03	0	RO	RSVD	Reserved
02	0	RWLO	RSVD	Reserved for future use
01	0	RWLO	UL	Upper 128-byte Lock: When set, bytes 38h-3Fh in the upper 128-byte bank of RTC RAM are locked. Writes will be dropped, and reads will not return any guaranteed data.

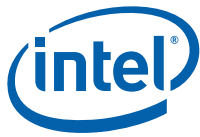

Table 65. 3400h: RC – RTC Configuration (Sheet 2 of 2)

Size: 32 bit		Default:		Power Well:
Access		Memory Mapped IO	BAR: RCBA	Offset: 3400h
Bit Range	Default	Access	Acronym	Description
00	0	RWLO	LL	Lower 128-byte Lock: When set, bytes 38h-3Fh in the lower 128-byte bank of RTC RAM are locked. Writes will be dropped, and reads will not return any guaranteed data.

5.5.4.2 Offset 3410h: BNT– Boot Configuration

Table 66. 3410h: BNT– Boot Configuration

Size: 32 bit		Default:		Power Well:
Access		Memory Mapped IO	BAR: RCBA	Offset: 3410h
Bit Range	Default	Access	Acronym	Description
31 : 02	0	RO	RSVD	Reserved
01	0	RWO	UL	Boot BIOS Strap Status: 1: Boot with the LPC interface 0: Boot from the SPI interface
00	0	RO	RSVD	Reserved

§ §



6.0 Memory Controller

6.1 Overview

The Intel® Atom™ Processor E6xx Series contains an integrated 32-bit single-channel memory controller that supports DDR2 memory in soldered down DRAM configurations only. The memory controller supports data rates of 800 MT/s. There is no support for ECC in the memory controller.

6.1.1 DRAM Frequencies and Data Rates

The memory controller supports the clock frequencies and data rates for DRAM listed in Table 67.

Table 67. Memory Controller Supported Frequencies and Data Rates

Memory Clock	DRAM Clock	DRAM Data Rate	DRAM Type	Peak Bandwidth
200 MHz	400 MHz	800 MT/s	DDR2	3.2 GB/s

6.2 DRAM Burst Length

The memory controller only supports a DRAM burst length of four 32-bit data chunks. For 32-byte read/write transactions, the memory controller performs two back-to-back 16-byte DRAM transactions. For 64-byte read/write transactions, the memory controller performs four back-to-back 16-byte DRAM transactions.

6.3 DRAM Partial Writes

The memory controller has support for partial writes to DRAM. There are four data mask pins (M_DM[3:0]), one pin per byte used to indicate which bytes should be written.

6.4 DRAM Power Management

Power Management involves managing and reducing the power consumed by both the memory controller and the DRAM devices. The DRAM devices provide two ways to reduce power consumption: Power Down mode and Self Refresh. The memory controller manages these two power saving modes and, in addition, controls a number of its own components to further reduce power consumption.

The memory controller supports memory power management in the following conditions:

- C0–C1: Power Down
- C2–C6: Dynamic Self Refresh
- S3: Self Refresh



6.4.1 Powerdown Modes

The memory controller employs aggressive use of memory power management features. When a rank is not being accessed, the CKE for that rank is deasserted, bringing the devices into a Power Down state. The memory controller supports Fast Power Down for DDR2 DRAMs.

6.4.2 Self Refresh Mode

Self Refresh can be used to retain data in the DRAM devices, even if the remainder of the system is powered down. When the memory is in Self Refresh, the memory controller disables all output signals except the CKE signals. The controller will enter Self Refresh as part of the S3 sequence, and stay in Self Refresh until an exit sequence is initiated.

There are two Self Refresh modes that the memory controller provides: Shallow and Deep. Deep Self Refresh provides for additional power savings over Shallow Self Refresh, but at the cost of increased exit latency. The power savings for Deep Self Refresh are achieved by optimizations in power gating and clock gating for the DDRIO PHY circuits. Both Self Refresh modes are transparent to the DRAM device, and the entry and exit commands are the same.

6.4.3 Dynamic Self Refresh Mode

The memory controller also supports Dynamic Self Refresh when the Intel® Atom™ Processor E6xx Series is in C2–C6 idle states. It wakes the memory from Self Refresh whenever memory access is needed; then it re-enters Self Refresh mode when no more requests are needed. Both Deep and Shallow Self Refresh modes are supported for Dynamic Self Refresh, selected by means of a configuration bit .

6.4.4 Page Management

The memory controller is capable of closing pages after these pages have been idle for an optimized period of time. This page management mechanism provides both power and performance benefits. From a performance standpoint, it helps since it can reduce the number of page misses encountered. From a power perspective, it allows the memory devices to reach the precharge power management state (power down when all banks are closed), which has better power saving characteristics on most memory devices than when the pages are left open and the device is in Active Power-Down mode.

6.5 Refresh Mode

The memory controller handles all DRAM refresh operations when the device is not in Self Refresh. To reduce the performance impact of DRAM refreshes, the memory controller can wait until eight refreshes are required and then issue all of these refreshes. This provides some increase in efficiency (overall lower percentage of impact to the available bandwidth), but there will also be a longer period of time that the memory will be unavailable, roughly $8 \times t_{RFC}$ (refresh cycle time).



6.6 Supported DRAM Configurations

The memory controller supports a single, 32-bit channel and up to eight soldered down DDR2 DRAM devices. The memory controller does not support SODIMM or any type of DIMMs. Table 68 shows the different supported memory configurations..

Table 68. Supported Memory Configurations for DDR2

Total System Memory Size	Rank 0				Rank 1				Config
	Rank Mem Size	Density/ DRAM Chip	DRAM Chips/ Rank	Chip Data Width	Rank Mem Size	Density/ DRAM Chip	DRAM Chips/ Rank	Chip Data Width	
128 MB	128 MB	256 Mb	4	x8					2Top + 2Bot
256 MB	256 MB	512 Mb	4	x8					2Top + 2Bot
512 MB	512 MB	1 Gb	4	x8					2Top + 2Bot
1 GB	1 GB	2 Gb	4	x8					2Top + 2Bot
128 MB	128 MB	512 Mb	2	x16					1Top + 1Bot or 2Top or 2Bot
256 MB	256 MB	1 Gb	2	x16					1Top + 1Bot or 2Top or 2Bot
512 MB	512 MB	2 Gb	2	x16					1Top + 1Bot or 2Top or 2Bot
256 MB	128 MB	512 Mb	2	x16	128 MB	512 Mb	2	x16	2Top + 2Bot
512 MB	256 MB	1 Gb	2	x16	256 MB	1 Gb	2	x16	2Top + 2Bot
1 GB	512 MB	2 Gb	2	x16	512 MB	2 Gb	2	x16	2Top + 2Bot
1 GB	512 MB	1 Gb	4	X8	512 MB	1 Gb	4	x8	4Top + 4Bot
2 GB	1 GB	2 Gb	4	x8	1 GB	2 Gb	4	x8	4Top + 4Bot

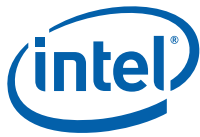

6.7 Supported DRAM Devices

Table 69. Supported DDR2 DRAM Devices

DRAM Density	Data Width	Banks	Bank Address	Row Address	Column Address	Page Size
256 Mb	x8	4	BA[1:0]	MA[12:0]	MA[9:0]	1 kB
512 Mb	x8	4	BA[1:0]	MA[13:0]	MA[9:0]	1 kB
1 Gb	x8	8	BA[2:0]	MA[13:0]	MA[9:0]	1 kB
2 Gb	x8	8	BA[2:0]	MA[14:0]	MA[9:0]	1 kB
512 Mb	x16	4	BA[1:0]	MA[12:0]	MA[9:0]	2 kB
1 Gb	x16	8	BA[2:0]	MA[12:0]	MA[9:0]	2 kB
2 Gb	x16	8	BA[2:0]	MA[13:0]	MA[9:0]	2 kB

6.8 Supported Rank Configurations

Table 70. Memory Size Per Rank

Memory Size/Rank	DRAM Chips/Rank	DRAM Chip Density	DRAM Chip Data Width	Banks/Chip	Page Size/Chip	Page Size @ 32-bit Data Bus
128 MB	4	256 Mb	x8	4	1 kB	4 kB = 1 kB x 4 Chips
256 MB	4	512 Mb	x8	4	1 kB	4 kB = 1 kB x 4 Chips
512 MB	4	1 Gb	x8	8	1 kB	4 kB = 1 kB x 4 Chips
1 GB	4	2 Gb	x8	8	1 kB	4 kB = 1 kB x 4 Chips
128 MB	2	512 Mb	x16	4	2 kB	4 kB = 2 kB x 2 Chips
256 MB	2	1 Gb	x16	8	2 kB	4 kB = 2 kB x 2 Chips
512 MB	2	2 Gb	x16	8	2 kB	4 kB = 2 kB x 2 Chips



6.9 Address Mapping and Decoding

For any rank, the address range it implements is mapped into the physical address regions of the devices on that rank. This is addressable by bank (B), row (R), and column (C) addresses. Once a rank is selected as described above, the range that it is implementing is mapped into the device's physical address as described in Table 71.

Table 71. DRAM Address Decoder (Sheet 1 of 2)

Tech	DDR2	DDR2	DDR2	DDR2	DDR2	DDR2	DDR2	DDR2
Rank Size	128 MB	128 MB	256 MB	256 MB	512 MB	512 MB	512 MB	1 GB
Density	256 Mb	512 Mb	512 Mb	1 Gb	1 Gb	1 Gb	2 Gb	2 Gb
Width	x8	x16	x8	x16	x8	x8	x16	x8
Bank Bits	2	2	2	3	3	3	3	3
Row Bits	13	13	14	13	14	14	14	15
Column Bits	10	10	10	10	10	10	10	10
A[31]								
A[30]								RS
A[29]						RS	RS	R14
A[28]			RS	RS	R13	R13	R13	R13
A[27]	RS	RS	R13	B2	B2	B2	B2	B2
A[26]	R12	R12	R12	R12	R12	R12	R12	R12
A[25]	R11	R11	R11	R11	R11	R11	R11	R11
A[24]	R10	R10	R10	R10	R10	R10	R10	R10
A[23]	R9	R9	R9	R9	R9	R9	R9	R9
A[22]	R8	R8	R8	R8	R8	R8	R8	R8
A[21]	R7	R7	R7	R7	R7	R7	R7	R7
A[20]	B1	B1	B1	B1	B1	B1	B1	B1
A[19]	R6	R6	R6	R6	R6	R6	R6	R6
A[18]	R5	R5	R5	R5	R5	R5	R5	R5
A[17]	R4	R4	R4	R4	R4	R4	R4	R4
A[16]	R3	R3	R3	R3	R3	R3	R3	R3
A[15]	R2	R2	R2	R2	R2	R2	R2	R2
A[14]	R1	R1	R1	R1	R1	R1	R1	R1

Notes:

1. R = Row Address bit
2. C = Column Address bit
3. B = Bank Select bit (M_BS[2:0])
4. RS = Rank select. If RS = 0, then Chip Select bit (M_CS[0]#). If RS = 1, the Chip Select bit (M_CS[1]#).

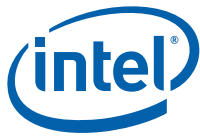

Table 71. DRAM Address Decoder (Sheet 2 of 2)

A[13]	R0	R0	R0	R0	R0	R0	R0	R0
A[12]	B0	B0	B0	B0	B0	B0	B0	B0
A[11]	C9	C9	C9	C9	C9	C9	C9	C9
A[10]	C8	C8	C8	C8	C8	C8	C8	C8
A[9]	C7	C7	C7	C7	C7	C7	C7	C7
A[8]	C6	C6	C6	C6	C6	C6	C6	C6
A[7]	C5	C5	C5	C5	C5	C5	C5	C5
A[6]	C4	C4	C4	C4	C4	C4	C4	C4
A[5]	C3	C3	C3	C3	C3	C3	C3	C3
A[4]	C2	C2	C2	C2	C2	C2	C2	C2
A[3]	C1	C1	C1	C1	C1	C1	C1	C1
A[2]	C0	C0	C0	C0	C0	C0	C0	C0

Notes:

1. R = Row Address bit
2. C = Column Address bit
3. B = Bank Select bit (M_BS[2:0])
4. RS = Rank select. If RS = 0, then Chip Select bit (M_CS[0]#). If RS = 1, the Chip Select bit (M_CS[1]#).





7.0 Graphics, Video, and Display

7.1 Chapter Contents

This chapter contains the following information:

- Overview
- 3D Core Key Features
- Video Encode Overview
- Video Decode Overview
- Display Overview
- Register Description

7.2 Overview

The Intel® Atom™ Processor E6xx Series contains an integrated graphics engine, video decode and encode capabilities, and a display controller that can support one LVDS display and one SDVO display (see [Figure 5](#)).

Figure 5. Graphics Unit

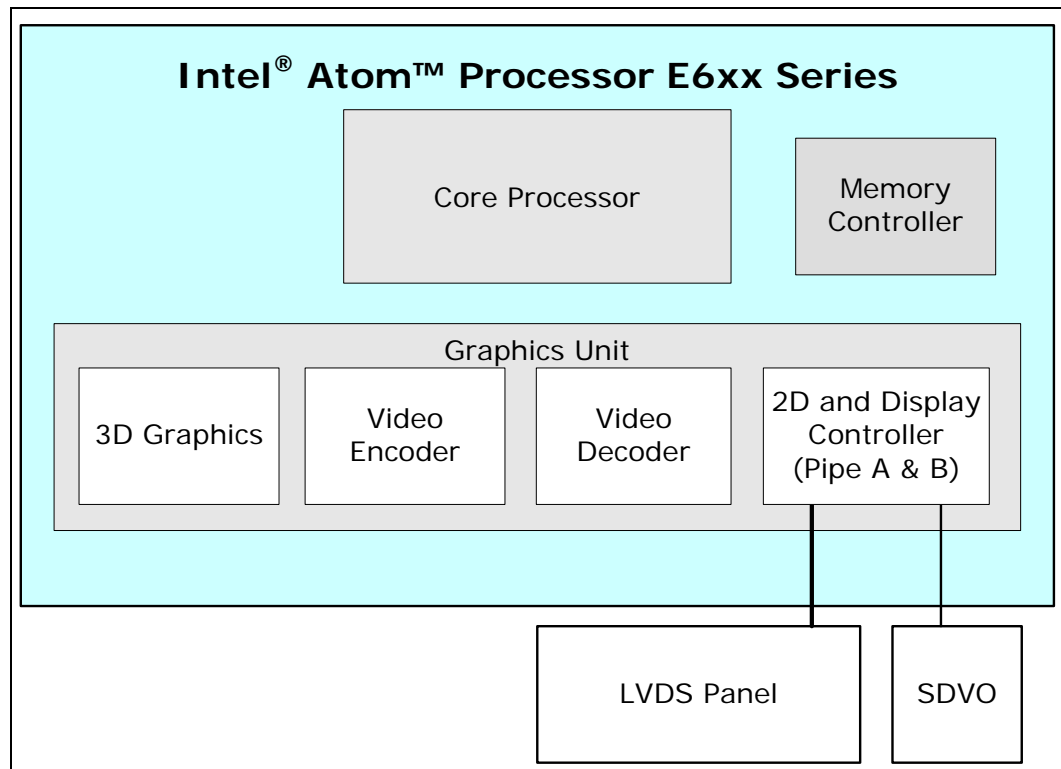

7.2.1 3D Graphics

The following lists the key features of the 3D graphics engine.

- Two pipe scalable unified shader implementation
 - 3D peak performance



- Fill rate: two pixels per clock
- Vertex rate: One triangle 15 clocks (transform only)
- Vertex/Triangle ratio average = 1 vtx/tri, peak 0.5 vtx/tri
- Texture maximum size = 2048 x 2048
- Programmable 4x multi-sampling anti-aliasing (MSAA)
 - Rotated grid
 - ISP performance related to AA mode, TSP performance unaffected by AA mode
- Optimized memory efficiency using multi-level cache architecture

7.2.2 Shading Engine Key Features

The unified pixel/vertex shader engine supports a broad range of instructions.

- Unified programming model
 - Multi-threaded with four concurrently running threads
 - Zero-cost swapping in/out of threads
 - Cached program execution model – unlimited program size
 - Dedicated pixel processing instructions
 - Dedicated vertex processing instructions
 - 2048 32-bit registers
- SIMD pipeline supporting operations in:
 - 32-Bit IEEE Float
 - 2-way, 16-bit fixed point
 - 4-way, 8-bit integer
 - 32-bit, bit-wise (logical only)
- Static and dynamic flow control
 - Subroutine calls
 - Loops
 - Conditional branches
 - Zero-cost instruction predication
- Procedural geometry
 - Allows generation of more primitives on output compared with input data
 - Effective geometry compression
 - High order surface support
- External data access
 - Permits reads from main memory by cache (can be bypassed)
 - Permits writes to main memory
 - Data fence facility provided
 - Dependent texture reads



7.2.3 Vertex Processing

Modern graphics processors perform two main procedures to generate 3D graphics. First, vertex geometry information is transformed and lit to create a 2D representation in the screen space. Those transformed and lit vertices are then processed to create display lists in memory. The pixel processor then rasterizes these display lists on a regional basis to create the final image.

The integrated graphic processor supports DMA data accesses from main memory. DMA accesses are controlled by a main scheduler and data sequencer engine. This engine coordinates the data and instruction flow for the vertex processing, pixel processing, and general purpose operations.

Transform and lighting operations are performed by the vertex processing pipeline. A 3D object is usually expressed in terms of triangles, each of which is made up of three vertices defined by X–Y–Z coordinate space. The transform and lighting process is performed by processing data through the unified shader core. The results of this process are sent to the pixel processing function. The steps to transform and light a triangle or vertex are explained below.

7.2.3.1 Vertex Transform Stages

- **Local space**—Relative to the model itself (e.g., using the model center at the reference point). Prior to being placed into a scene with other objects.
- **World space: (transform LOCAL to WORLD)**—This is needed to bring all objects in the scene together into a common coordinate system.
- **Camera space (transform WORLD to CAMERA (also called EYE))**—This is required to transform the world in order to align it with camera view. In OpenGL the local to world and world to camera transformation matrix is combined into one, called the ModelView matrix.
- **Clip space (transform CAMERA to CLIP)**—The projection matrix defines the viewing frustum onto which the scene will be projected. Projection can be orthographic, or perspective. Clip is used because clipping occurs in clip space.
- **Perspective space (transform CLIP to PERSPECTIVE)**—The perspective divide is basically what enables 3D objects to be projected onto a 2D space. A divide is necessary to represent distant objects as smaller on the screen. Coordinates in perspective space are called normalized device coordinates ([-1, 1] in each axis).
- **Screen space (transform PERSPECTIVE to SCREEN)**—This space is where 2D screen coordinates are finally computed, by scaling and biasing the normalized device coordinates according to the required render resolution.

7.2.3.2 Lighting Stages

Lighting is used to generate modifications to the base color and texture of vertices; examples of different types of lighting are:

- **Ambient** lighting is constant in all directions and the same color to all pixels of an object. Ambient lighting calculations are fast, but objects appear flat and unrealistic.
- **Diffuse** lighting takes into account the light direction relative to the normal vector of the object's surface. Calculating diffuse lighting effects takes more time because the light changes for each object vertex, but objects appear shaded with more three-dimensional depth.
- **Specular** lighting identifies bright reflected highlights that occur when light hits an object surface and reflects toward the camera. It is more intense than diffuse light and falls off more rapidly across the object surface. Although it takes longer to



calculate specular lighting than diffuse lighting, it adds significant detail to the surface of some objects.

- **Emissive** lighting is light that is emitted by an object, such as a light bulb.

7.2.4 Pixel Processing

After vertices are transformed and lit by the vertex processing pipeline, the pixel processor takes the vertex information and generates the final rasterized pixels to be displayed. The steps of this process include removing hidden surfaces, applying textures and shading, and converting pixels to the final display format. The vertex/pixel shader engine is described in [Section 7.2.5](#).

The pixel processing operations also have their own data scheduling function that controls image processor functions and the texture and shader routines.

7.2.4.1 Hidden Surface Removal

The image processor takes the floating-point results of the vertex processing and further converts them to polygons for rasterization and depth processing. During depth processing, the relative positions of objects in a scene, relative to the camera, are determined. The surfaces of objects hidden behind other objects are then removed from the scene, thus preventing the processing of un-seen pixels. This improves the efficiency of subsequent pixel-processing.

7.2.4.2 Applying Textures and Shading

After hidden surfaces are removed, textures and shading are applied. Texture maps are fetched, mipmaps calculated, and either is applied to the polygons. Complex pixel-shader functions are also applied at this stage.

7.2.4.3 Final Pixel Formatting

The pixel formatting module is the final stage of the pixel-processing pipeline and controls the format of the final pixel data sent to the memory. It supplies the unified shader with an address into the output buffer, and the shader core returns the relevant pixel data. The pixel formatting module also contains scaling functions, as well as a dithering and data format packing function.

7.2.5 Unified Shader

The unified shader engine contains a specialized programmable microcontroller with capabilities specifically suited for efficient processing of graphics geometries (vertex shading), graphics pixels (pixel shading), and general-purpose video and image processing programs. In addition to data processing operations, the unified shader engine has a rich set of program-control functions permitting complex branches, subroutine calls, tests, etc., for run-time program execution.

The unified shader core also has a task and thread manager which tries to maintain maximum performance utilization by using a 16-deep task queue to keep the 16 threads full.

The unified store contains 16 banks of 128 registers. These 32-bit registers contain all temporary and output data, as well as attribute information. The store employs features which reduce data collisions such as data forwarding, pre-fetching of a source argument from the subsequent instruction. It also contains a write back queue.

Like the register store, the arithmetic logic unit (ALU) pipelines are 32-bits wide. For floating-point instructions, these correlate to IEEE floating point values. However, for integer instructions, they can be considered as one 32-bit value, two 16-bit values, or



four 8-bit values. When considered as four 8-bit values, the integer unit effectively acts like a four-way SIMD ALU, performing four operations per clock. It is expected that in legacy applications pixel processing will be done on 8-bit integers, roughly quadrupling the pixel throughput compared to processing on float formats.

7.2.6 Multi Level Cache

The multi-level cache is a three-level cache system consisting of two modules, the main cache module and a request management and formatting module. The request management module also provides Level-0 caching for texture and unified shader core requests.

The request management module can accept requests from the data scheduler, unified shaders and texture modules. Arbitration is performed between the three data streams, and the cache module also performs any texture decompression that may be required.

7.3 Video Encode

The Intel® Atom™ Processor E6xx Series supports full hardware video encode. The video encode hardware accelerator improves video capture performance by providing dedicated hardware-based acceleration. Other benefits are low power consumption, low host processor load, and high picture quality. The processor supports full hardware acceleration of the following video encode:

- Permits 720P30 H.264 BP encode
- MPEG4 encode and H.263 video conferencing

With integrated hardware encoding the host processor only needs to deal with higher-level control code functions, such as providing the image to encode and processing the video elementary stream.

The processor supports a standard definition video encoder that has as an input, a series of frames which are encoded to produce an elementary bit stream. This section describes the top level interactions between all modules contained in encode hardware.

7.3.1 Supported Input Formats

The following input formats are supported for the video input planar Luma and planar or interleaved Chroma 4:2:0. The following is a list of the formats:

- YUV IMC2 Planar Pixel Format
- YUV YV12 Planar Pixel Format
- YUV PL8 Planar Pixel Format
- YUV PL12 Planar Pixel Format

The first stage is to fetch the data in its original format UYVYUYVYUYVYUYVY and then translate this to the following format UVUVUVUV YYYYYYYY. Only the Chroma data is TDMA'd back to the EIOB and then TDMA'd from the EIOB back into the ESB again to de-interleave the chroma components.

7.3.1.1 Encoding Pipeline

In general, the encoding process is pipelined into a number of stages. For MPEG-4/H.263/H.264 encoding, the data is processed in macroblocks, with a minimum of interaction from the embedded controller within each processing stage.



7.3.1.2 Encode Codec Support

The Intel® Atom™ Processor E6xx Series supports the following profiles and levels as shown in Table 72.

Table 72. Encode Profiles and Levels of Support

Standard	Profile	Maximum Bit Rate (bps)	Typical Picture and Frame Rate
H.264	BP	128K	QCIF @15 fps
H.264	BP	192K	QCIF @30 fps
H.264	BP	384K	CIF @15 fps or QVGA @ 20 fps
H.264	BP	2M	CIF @ 30 fps or QVGA @ 30 fps
H.264	BP	10M	720x480 @ 30 fps, 720x576 @ 25 fps, VGA @ 30 fps
MPEG4	SP	64K	QCIF @ 15 fps
MPEG4	SP	128K	QCIF @ 30 fps, CIF @ 15 fps, QVGA @ 15 fps
MPEG4	SP	384K	CIF @ 30 fps or QVGA @ 30 fps
MPEG4	SP	128K	QCIF @ 15 fps
MPEG4	SP	384K	QCIF @ 30 fps, CIF @ 15 fps, QVGA @ 15 fps
MPEG4	SP	768K	CIF @ 30 fps or QVGA @ 30 fps
MPEG4	SP	8M	720x480 @ 30 fps, 720x576 @ 25 fps, VGA @ 30 fps
H.263	BP	64K	QCIF @ 15 fps
H.263	BP	128K	QCIF @ 30 fps, CIF @ 15 fps, QVGA @ 15 fps
H.263	BP	384K	CIF @ 30 fps, QVGA @ 30 fps
H.263	BP	2M	CIF @ 30 fps, QVGA @ 30 fps
H.263	BP	128K	QCIF @ 15 fps
H.263	BP	4M	CIF @ 60 fps
H.263	BP	8M	720x240 @ 60 fps, 720x288 @ 50 fps
H.264	MP	14M	1280x720 @ 30 fps
MPEG4	SP		1280x720 @ 30 fps
H.263	BP	16M	720x480 @ 60 fps, 720x576 @ 50 fps

7.3.1.3 Encode Specifications Supported

ITU-T H.264 (03/2005)

- Series H—Audio-visual and multimedia systems. Infrastructure of audio-visual services—Coding of moving video—Advanced video coding for generic audio-visual services

H.263 (01/2005)

- Series H—Audio-visual and multimedia systems. Infrastructure of audio-visual services—Coding of moving video – Video coding for low bit rate communication

MPEG4 (06/2004)

- ISO/IEC 14496-2 Second edition, Information Technology—Coding of audio-visual objects - Part 2: Visual

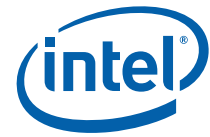

7.4 Video Decode

The video decode accelerator improves video performance/power by providing hardware-based acceleration at the macroblock level (variable length decode stage entry point). The Intel® Atom™ Processor E6xx Series supports full hardware acceleration of the following video decode standards.

Table 73. Hardware Accelerated Video Decoding Support

Codec	Profile	Level	Note
H.264	Baseline profile	L3	
H.264	Main profile	L4.1 (1080p @ 30 fps)	
H.264	High profile	L4.1 (1080p @ 30 fps)	
MPEG2	Main profile	High	
MPEG4	Simple profile	L3	
MPEG4	Advanced simple profile	L5	
VC1	Simple profile	Medium	
VC1	Main profile	High	
VC1	Advanced profile	L3 up to (1080p @ 30 fps)	
WMV9	Simple profile	Medium	
WMV9	Main profile	High	

Video Decode is performed in four processing modules, which are described in the following sections:

- Entropy coding processing
- Motion compensation
- Deblocking
- Final pixel formatting

7.4.1 Entropy Coding

The entropy encoding module serves as the master controller for the video accelerator. The master data stream control and bitstream parsing functions for the macroblock level and below are performed here. Required control parameters are sent to the motion compensation and deblocking modules.

The macroblock bit-stream parsing performs the entropy encoding functions for VLC, CALVC, and CABAC techniques used in video codecs. The entropy encoding module also performs the motion vector reconstruction using the motion vector predictors.

After entropy encoding, the iDCT coefficients are extracted and inverse scan ordered. Then inverse quantization, rescaling, and AC/DC coefficient processing is performed.

The re-scaled coefficients are passed to the Inverse Transform engine for processing. The Hadamard transform is also supported and performed. The inverse-transformed data is connected to the output port of entropy coding module, which provides the residual data to the motion compensation module.



7.4.1.1 Motion Compensation

The entropy encoder or host can write a series of commands to define the type of motion predication used. The motion predicated data is then combined with residual data, and the resulting reconstructed data is passed to the de-blocker.

The Motion Compensation module is made-up of four sub-modules:

- The Module Control Unit module controls the overall motion compensation operation. It parses the command stream to detect errors in the commands sent, and extracts control parameters for use in later parts of the processing pipeline. The Module Control Unit also accepts residual data (either direct from VEC or by a system register), and re-orders the frame/field format to match the predicted tile format.
- The Reference Cache module accepts the Inter/Intra prediction commands, along with the motion vectors and index to reference frame in the case of Inter prediction. The module calculates the location of reference data in the frame store (including out-of-bounds processing requirements). The module includes cache memory, which is checked before external system memory reads are requested (the cache can significantly reduce system memory bandwidth requirements). In H264 mode, the module also extracts and stores Intra-boundary data, which is used in Intra prediction. The output of the reference cache is passed to the 2D filter module.
- The 2D filter module implements up to eight tap Vertical and Horizontal filters to generate predicted data for sub-pixel motion vectors (to a resolution of up to 1/8th of a pixel). The 2D filter module also generates H.264 intra prediction tiles (based on the intra prediction mode and boundary data extracted by the reference cache). For VC1 and WMV9, the 2D filter module also implements Range scaling and Intensity Compensation on inter reference data prior to sub-pixel filtering.
- The Pixel Reconstruction Unit combines predicted data from the 2D filter with the re-ordered residual data from the Module Control Unit. In the case of bidirectional macroblocks with two motion vectors per tile, the Pixel Reconstruction Unit combines the two tiles of predicted data prior to combining the result with residual data. In the case of H.264, the Pixel Reconstruction Unit also implements weighted averaging. The final reconstructed data is then passed to the VDEB for de-blocking (as well as being fed-back to the reference cache so that intra-boundary data can be extracted).

7.4.1.2 Deblocking

The deblocking module is responsible for codec back-end video filtering. It is the last module within the high definition video decoder module pipeline. The deblocking module performs overlap filtering and in-loop de-blocking of the reconstructed data generated by the motion-compensation module. The frames generated are used for display and for reference of subsequent decoded frames.

The deblocking module performs the following specific codec functions:

- H.264 Deblocking, including ASO modes
- VC-1/WMV9 overlap filter and in-loop deblocking
- Range-mapping
- Pass-through of reconstructed data for codec-modes that do not require deblocking (MPEG2, MPEG4).

7.4.1.3 Output Reference Frame Storage Format

Interlaced pictures (as opposed to progressive pictures) are always stored in system memory as interlaced frames, including interlaced field pictures.



7.4.1.4 Pixel Format

The pixel format has the name 420PL12YUV8. This consists of a single plane of luma (Y) and a second plane consisting of interleaved Cr/Cb (V/U) components. For 420PL12YUV8, the number of chroma samples is a quarter of the quantity of luma samples—half as many vertically, half as many horizontally. See [Table 74](#) and [Table 75](#) for pixel formats.

Table 74. Pixel Format for the Luma (Y) Plane

Bit	Symbol	Description
63:56	Y7[7:0]	8-bit Y luma component
55:48	Y6[7:0]	8-bit Y luma component
47:40	Y5[7:0]	8-bit Y luma component
39:32	Y4[7:0]	8-bit Y luma component
31:24	Y3[7:0]	8-bit Y luma component
23:16	Y2[7:0]	8-bit Y luma component
15:8	Y1[7:0]	8-bit Y luma component

Table 75. Pixel Formats for the Cr/Cb (V/U) Plane

Bit	Symbol	Description
Format 1		
7:0	Y0[7:0]	8-bit Y luma component
63:56	U3[7:0]	8-bit U/Cb chroma component
55:48	V3[7:0]	8-bit V/Cr chroma component
47:40	U2[7:0]	8-bit U/Cb chroma component
39:32	V2[7:0]	8-bit V/Cr chroma component
31:24	U1[7:0]	8-bit U/Cb chroma component
23:16	V1[7:0]	8-bit V/Cr chroma component
15:8	U0[7:0]	8-bit U/Cb chroma component
7:0	V0[7:0]	8-bit V/Cr chroma component
Format 2 (Cr and Cb are reversed relative to Format 1)		
63:56	V3[7:0]	8-bit U/Cr chroma component
55:48	U3[7:0]	8-bit V/Cb chroma component
47:40	V2[7:0]	8-bit U/Cr chroma component
39:32	U2[7:0]	8-bit V/Cb chroma component
31:24	V1[7:0]	8-bit U/Cr chroma component
23:16	U1[7:0]	8-bit V/Cb chroma component
15:8	V0[7:0]	8-bit U/Cr chroma component
7:0	U0[7:0]	8-bit V/Cb chroma component

7.5 Display

The Display Controller provides the 2D graphics functionalities for the display pipeline. The Display Controller converts a set of source images or surfaces, and merges them and delivers them at the proper timing to output interfaces that are connected to the

LVDS display devices (see Figure 6). Along the display pipe, the display data can be converted from one format to another, stretched or shrunk, and color corrected or gamma converted.

Figure 6. Display Link Interface

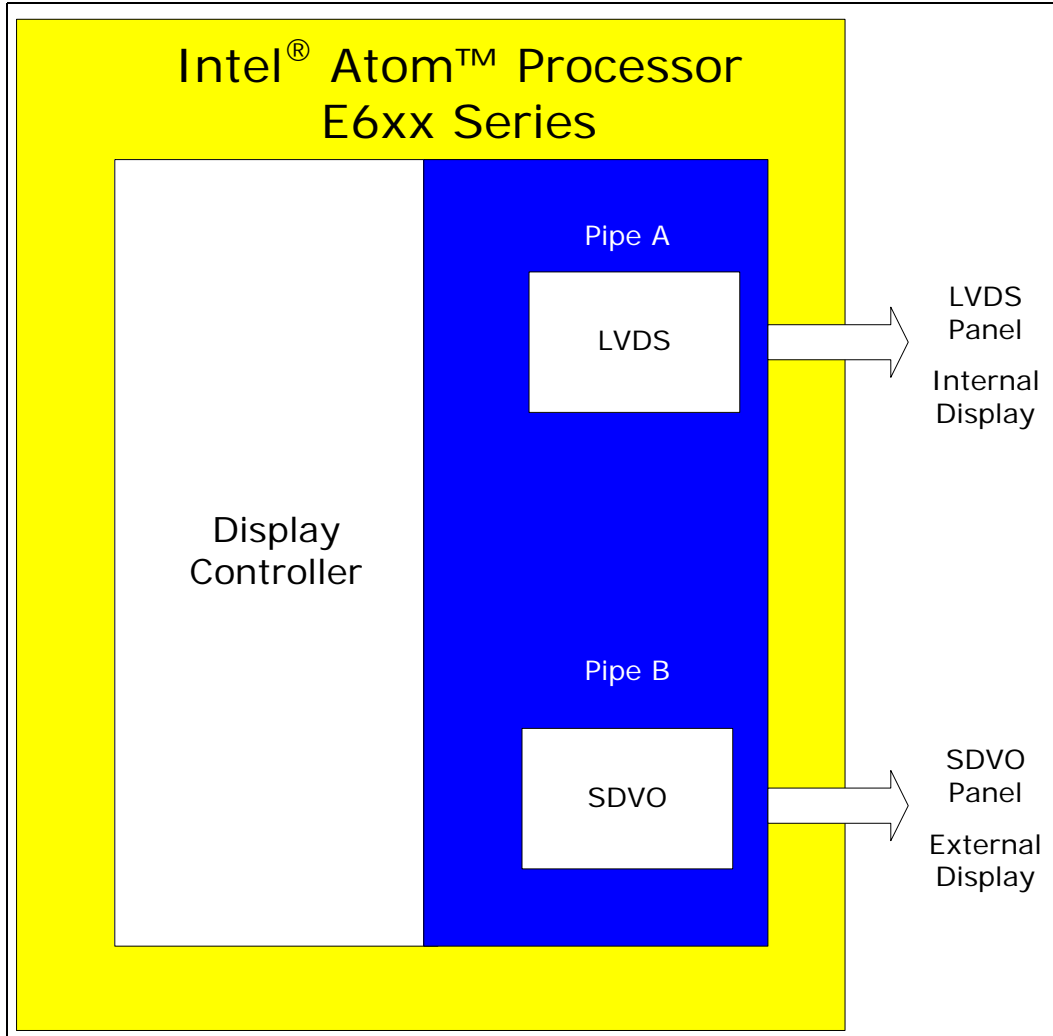

The Display Controller supports five display planes and two cursor planes and is running in the core display clock domain.

The Display Controller supports the following features:

- Seven planes: Display Plane A, B, Display C/sprite, Overlay, Cursor A, Cursor B, and VGA
- Dual Independent display pipes, Pipe A and Pipe B
 - Display Pipe A: Outputs directly as LVDS
 - Display Pipe B: Outputs directly as SDVO
- Supports 64-bit FP color format, NPO2 Tiling, and 180 degree rotation
- Output pixel width: 24-bit RGB (LVDS 24.1, 24.0 and 18.0 as well).
- Supports NV12 data format



- 3x3 Panel Fitter shared by two pipes
- Support Constant Alpha mode on Display C/Video sprite plane
- DPST 3.0

The display contains the following functions:

- Display data fetching
- Out of order display data handling
- Display blending
- Gamma correction
- Panel fitter function

7.5.1 Display Output Stages

The display output can be divided into three stages:

- Planes
 - Request/Receive data from memory
 - Format memory data into pixels
 - Handle fragmentation, tiling, physical address mapping
- Pipes
 - Generate display timing
 - Scaling, LUT
- Ports
 - Format pixels for output (LVDS or SDVO)
 - Interface to physical layer

7.5.1.1 Planes

The Display Controller contains a variety of planes (such as Display and Cursor). A plane consists of a rectangular shaped image that has characteristics (such as source, size, position, method, and format). These planes get attached to source surfaces, which are rectangular areas in memory with a similar set of characteristics. They are also associated with a particular destination pipe.

- **Display Plane**—The primary and secondary display plane works in an indexed mode, hi-color mode, or a true color mode. The true color mode allows for an 8-bit alpha channel. One of the primary operations of the display plane is the set mode operation. The set-mode operation occurs when it is desired to enable a display, change the display timing, or source format. The secondary display plane can be used as a primary surface on the secondary display or as a sprite planes on either the primary or secondary display.
- **Cursor Plane**—The cursor plane is one of the simplest display planes. With a few exceptions, the cursor plane supports sizes of 64 x 64, 128 x 128 and 256 x 256 fixed Z-order (top). In legacy modes, cursor can cause the display data below it to be inverted.
- **VGA Plane**—VGA mode provides compatibility for pre-existing software that set the display mode using the VGA CRTC registers. VGA Timings are generated based on the VGA register values (the hi-resolution timing generator registers are not used).



Note: The Intel® Atom™ Processor E6xx Series has limited support for a VGA Plane. The VGA plane is suitable for usages, such as BIOS boot screens, pre-OS splash screens, etc. Other usages of the VGA plane (like DOS-based games, for example) are not supported.

7.5.1.2 Display Pipes

The display consists of two pipes:

- Display Pipe A
- Display Pipe B

A pipe consists of a set of combined planes and a timing generator. The timing generators provide timing information for each of the display pipes. The Intel® Atom™ Processor E6xx Series has two independent display pipes that can allow for support of two independent display streams. A port is the destination for the result of the pipe.

Pipe A can operate in a single-wide mode.

The Clock Generator Units (DPLL) provides a stable frequency for driving display devices. It operates by converting an input reference frequency into an output frequency. The timing generators take their input from internal DPLL devices that are programmable to generate pixel clocks to a maximum pixel clock rate up to 80 MHz for LVDS and 160 MHz for SDVO.

Note: Unused display PLLs can be disabled to save power.

7.5.2 Display Ports

Display ports are the destination for the display pipe. These are the places where the display data finally appears to devices outside the graphics device. The Intel® Atom™ Processor E6xx Series has one dedicated LVDS and one SDVO port.

Since two display ports available for its two pipes, the processor can support up to two different images on two different display devices. Timings and resolutions for these two images may be different.



Figure 7. Display Resolutions

Resolution	Refresh	Pixel Clock Freq	sDVO support	LVDS support	
640x480	50 Hz	19.75 MHz	Y	Y	
640x480	60 Hz	23.75 MHz	Y	Y	
848x480	50 Hz	26 MHz	Y	Y	
848x480RB	60 Hz	29.75 MHz	Y	Y	
640x480	75 Hz	30.75 MHz	Y	Y	
800x600	50 Hz	30.75 MHz	Y	Y	
848x480	60 Hz	31.5 MHz	Y	Y	
640x480	85 Hz	35 MHz	Y	Y	
800x600RB	60 Hz	35.5 MHz	Y	Y	
800x600	60 Hz	38.25 MHz	Y	Y	
848x480	75 Hz	41 MHz	Y	Y	
848x480	85 Hz	46.75 MHz	Y	Y	
800x600	75 Hz	49 MHz	Y	Y	
1024x768	50 Hz	52 MHz	Y	Y	
1024x768RB	60 Hz	56 MHz	Y	Y	
800x600	85 Hz	56.75 MHz	Y	Y	
1024x768	60 Hz	63.5 MHz	Y	Y	
1280x768	50 Hz	65.25 MHz	Y	Y	
1280x768RB	60 Hz	68.25 MHz	Y	Y	
1280x768	60 Hz	79.5 MHz	Y	Y	Max LVDS interface support
1400x1050	60 Hz	121.75 MHz	Y		
1280x960	75 Hz	130 MHz	Y		
1600x1200RB	60 Hz	130.25 MHz	Y		
1600x1200	50 Hz	131.5 MHz	Y		
1920x1080RB	60 Hz	138.5 MHz	Y		
1280x1024	75 Hz	138.75 MHz	Y		
1920x1080	50 Hz	141.5 MHz	Y		
1280x960	85 Hz	148.25 MHz	Y		
1400x1050	75 Hz	156 MHz	Y		
1280x1024	85 Hz	159.5 MHz	Y		Max SDVO interface support

7.5.2.1 LVDS Port

A single LVDS channel only is supported. The single LVDS channel can support clock frequency ranges up to a maximum pixel clock rate up to 80 MHz.

The graphics core is responsible to read the EDID ROM from the installed panel (if present) specifications through I²C* interface and the software driver uses it to program the pipe A timing registers.

The Intel® Atom™ Processor E6xx Series supports a single LVDS channel with several modes and data formats. The single LVDS channel consists of 4 data pairs and a clock pair. The phase locked transmit clock is transmitted over the LVDS clock pair in parallel with the data being sent out over the data pairs. The pixel serializer supports 8-bit or 6-bit per color channel. The display data from the display pipe is sent to the LVDS

transmitter port at the dot clock frequency, which is determined by the panel timing requirements. The serialized output of LVDS is running at the serial clock of 7x dot clock frequency.

The transmitter can operate in a variety of modes and supports several data formats. The serializer supports 6-bit or 8-bit color per lane (for 18-bit and 24-bit color respectively) and single-channel operating modes. The display stream from the display pipe is sent to the LVDS transmitter port at the dot clock frequency, which is determined by the panel timing requirements. The output of LVDS is running at a fixed multiple of the dot clock frequency.

The single LVDS channel can take 18 or 24 bits of RGB pixel data plus 3 bits of timing control (HSYNC/VSYNC/DE) and output them on four differential data pair outputs.

This display port is normally used in conjunction with the pipe functions of panel up-scaling and 6-to 8-bit dither. This display port is also used in conjunction with the panel power sequencing and additional associated functions.

When enabled, the LVDS constant current drivers consume significant power. Individual pairs or sets of pairs can be selected to be powered down when not being used. However, when disabled, individual or sets of pairs will enter a low power state. When the port is disabled, all pairs enters a low power mode. The panel power sequencing can be set to override the selected power state of the drivers during power sequencing.

7.5.2.2 LVDS Backlight Control

To support LVDS Backlight Control, the Intel® Atom™ Processor E6xx Series will generate five types of messages to the display cluster. The display cluster will in turn drive VDDEN and BKLTEN and modulate the duty cycle before driving it out through BKLCTL. These three signals are multiplexed with the normal GPIO pins under the LVDS_CTL_MODE (address to be defined). The DDC_CLK and DDC_DATA is emulated through software.

Figure 8. LVDS Control Signal Solution

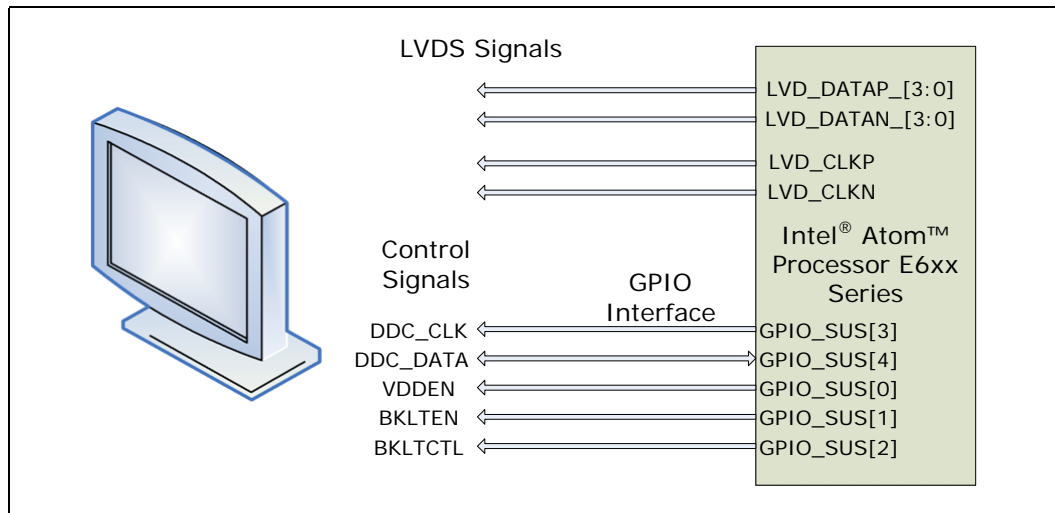

7.5.2.3 SDVO Digital Display Port

Display Pipe B is configured to use the SDVO port. The SDVO port can support a variety of display types (VGA, LVDS, DVI, TV-Out, etc.) by an external SDVO device. SDVO devices translate SDVO protocol and timings to the desired display format and timings.

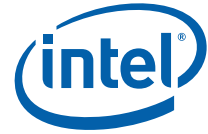

A maximum pixel clock of 160 MHz is supported on the SDVO interface.

7.5.2.4 SDVO DVI/HDMI

DVI (and HDMI), a 3.3-V interface standard supporting the TMDS protocol, is a prime candidate for SDVO. The Intel® Atom™ Processor E6xx Series provides an unscaled mode where the display data is centered within the attached display area. Monitor Hot Plug functionality is supported.

7.5.2.4.1 SDVO LVDS

The Intel® Atom™ Processor E6xx Series can use the SDVO port to drive an LVDS transmitter. Flat Panel is a fixed resolution display. The processor supports panel fitting in the transmitter, receiver or an external device, but has no native panel fitting capabilities. The processor provides an unscaled mode where the display data is centered within the attached display area. Scaling in the LVDS transmitter through the SDVO stall input pair is also supported.

7.5.2.4.2 SDVO TV-Out

The SDVO port supports both standard and high-definition TV displays in a variety of formats. The SDVO port generates the proper blank and sync timing, but the external encoder is responsible for generation of the proper format signal and output timings.

The processor will support NTSC/PAL/SECAM standard definition formats. The processor will generate the proper timing for the external encoder. The external encoder is responsible for generation of the proper format signal.

7.5.2.4.3 Flicker Filter and Overscan Compensation

The overscan compensation scaling and the flicker filter is done in the external TV encoder chip. Care must be taken to allow for support of TV sets with high performance de-interlacers and progressive scan displays connected to by way of a non-interlaced signal. Timing will be generated with pixel granularity to allow more overscan ratios to be supported.

7.6 Control Bus

The SDVO port defines a two-wire (SDVO_CTRLCLK and SDVO_CTRLDATA) communication path between the SDVO device and the processor. Traffic destined for the PROM or DDC will travel across the control bus, and will then require the SDVO device to act as a switch and direct traffic from the control bus to the appropriate receiver. The control bus is able to operate at up to 1 MHz.

Display Pipe B is configured to use the SDVO port. The SDVO port can support a variety of display types (VGA, LVDS, DVI, TV-Out, etc.) by an external SDVO device. SDVO devices translate SDVO protocol and timings to the desired display format and timings. A maximum pixel clock of 160 MHz is supported on the SDVO interface.



7.7 Configuration Registers

7.7.1 D2:F0 PCI Configuration Registers

Table 76. PCI Header for D2

Offset	Register	Description
00h	GVD.ID	D2: PCI Device and Vendor ID Register
04h	GVD.PCICMDSTS	PCI Command and Status Register
08h	GVD.RIDCC	Revision Identification and Class Codes
0Ch	GVD.HDR	Header Type
10h	GVD.MMADR	Memory Mapped Address Range. This is the base address for all memory mapped registers.
14h	GVD.GFX_IOBAR	I/O Base Address. This is used only by SBIOS and is the base address for the MMIO_INDEX and MMIO_DATA registers.
18h	GVD.GMADR	Graphics Memory Address Range
1Ch	GVD.GTTADR	Graphics Translation Table Address Range
2Ch	GVD.SSID	Subsystem Identifiers
34h	GVD.CAPPOINT	Capabilities Pointer
3Ch	GVD.INTR	Interrupt. This register is programmed by SBIOS. It is not used by the graphics/display driver.
50h	GVD.MGGC	Graphics Control
5Ch	GVD.BSM	Base of Stolen Memory
60h	GVD.MSAC	Multi Size Aperture Control
90h	GVD.MSI_CAPID	Message Signaled Interrupts Capability ID and Control Register
94h	GVD.MA	Message Address
98h	GVD.MD	Message Data
B0h	GVD.VCID	Vendor Capability ID
B4h	GVD.VC	Vendor Capabilities
C4h	GVD.FD	Functional Disable. This register is used by SBIOS, not by driver.
D0h	GVD.PMCAP	Power Management Capabilities
D4h	GVD.PMCS	Power Management Control/Status. Driver does not use this register. SBIOS doesn't use this register.
E0h	GVD.SWSMISCI	Software SMI or SCI
E4h	GVD.ASLE	System Display Event Register. SBIOS writes this register to generate an interrupt to the graphics/display driver.
F4h	GVD.LBB	Legacy Backlight Brightness. The display driver in the processor does not use this register since ASLE is available.
F8h	GVD.MANUFACTURING_ID	Manufacturing ID
FCh	GVD.ASLS ASL	Storage. The processor display driver does not need this register since memory Operational Region (OpRegion) is available. This register is kept for use as scratch space.



Table 77. 00h: GVD.ID – D2: PCI Device and Vendor ID Register

Size: 32 bit		Default: 41088086h		Power Well: Core
Access		PCI Configuration B:D:F 0:2:0		Offset Start: 00h Offset End: 01h
		Message Bus Port: 06h		Register Address: 00h
Bit Range	Default	Access	Acronym	Description
31 : 20	410h	RO		DIDH: Identifier assigned to the Device 2 Graphics PCI device. Bits[31:20] of this register are strapped at the processor top level.
19 : 16	fus_GfxDevID_nczfwoh [3:0]	RO		DIDL: Identifier assigned to the Device 2 Graphics PCI device. Bits[19:16] of this register are determined by fuse fus_GfxDevID_nczfwoh.
15 : 0	8086h	RO		VID: PCI standard identification for Intel.

Table 78. 04h: GVD.PCICMDSTS – PCI Command and Status Register (Sheet 1 of 2)

Size: 32 bit		Default: 00100000h		Power Well: Core
Access		PCI Configuration B:D:F 0:2:0		Offset Start: 04h Offset End:
		Message Bus Port: 06h		Register Address: 01h
Bit Range	Default	Access	Acronym	Description
31 : 21	0h	RO	RESERVED	Reserved
20	1b	RO	CAPABILITY_LIST	CAP: Indicates that the CAPPOINT register at 34h provides an offset into PCI Configuration Space containing a pointer to the location of the first item in the list.
19	0b	RO	INTERRUPT_STATUS	IS: Reflects the state of the interrupt in the graphics device. Is set to 1 if the aggregate display/gfx/ved/vpb/vec interrupt (as determined by IIR and IER memory interface registers) is set to 1. Otherwise is set to 0.
18 : 16	0h	RO	RESERVED	Reserved
15 : 11	0000b	RO	RESERVED	Reserved
10	0b	RW	INTERRUPT_DISABLE	ID: When 1, blocks the sending of a Message bus interrupt. The interrupt status is not blocked from; being reflected in PCICMDSTS.IS. When 0, permits the sending of a Message bus interrupt.
9 : 3	0000000b	RO	RESERVED	Reserved
2	0b	RW	BUS_MASTER_ENABLE	BME: Enables GVD to function as a PCI compliant master. When 0, blocks the sending of MSI interrupts. When 1, permits the sending of MSI interrupts.
1	0b	RW	MEMORY_SPACE_ENABLE	MSE: When set, accesses to this device's memory space is enabled. When 1, the GVD will compare scdwn3_address[31:20] with; MMADR[31:20]. As well, GVD will compare the address scdwn3_address[31:29,28, or 27] with GMADR[31:29,28, or 27], respectively. (Whether the comparison is 31:29, 31:28 or 31:27 depends on the value of MSAC[17:16].) As well, the GVD will check if scdwn3_address[31:0] is in the VGA memory range. (The VGA memory range is A0000h to BFFFFh). If there is a match (with MMADR, or GMADR, or VGA memory address range) and if the SCL command is either a MEMRD or MEMWR, the GVD will select the command (i.e. issue a scdwn3_hit). Care should be taken in setting up MMADR and GMADR that more than 1 match is not made as this will result in unpredictable behavior. When 0, the GVD will not select a MEMRD or MEMWR SCL command.



Table 78. 04h: GVD.PCI_CMDSTS – PCI Command and Status Register (Sheet 2 of 2)

Size: 32 bit		Default: 00100000h		Power Well: Core
Access	PCI Configuration		B:D:F 0:2:0	Offset Start: 04h Offset End:
	Message Bus		Port: 06h	Register Address: 01h
Bit Range	Default	Access	Acronym	Description
0	0b	RW	IO_SPACE_ENABLE	IOSE: When set, accesses to this device's I/O space is enabled. When 1, the GVD will check if sclown3_address[15:0] is in the VGA IO range. (The VGA IO range is 03B0h - 03BBh and 03C0h - 03DFh.) As well, the GVD will check sclown3_address[15:3] with GFX_IOBAR[15:3]. If there is a match (with VGA IO address range or GFX_IOBAR) and if the SCL command is either an IORD or IOWR, the GVD will select the command (i.e. issue a sclown3_hit). Care should be taken in setting up GFX_IOBAR that more than 1 match is not made as this will result in unpredictable behavior. When 0, the GVD will not select a IORD or IOWR SCL command.

Table 79. 08h: GVD.RIDCC - Revision Identification and Class Code

Size: 32 bit		Default:		Power Well: Core
Access	PCI Configuration		B:D:F 0:2:0	Offset Start: 08h Offset End:
	Message Bus		Port: 06h	Register Address: 02h
Bit Range	Default	Access	Acronym	Description
31 : 24	03h	RO	BASE_CLASS_CODE	BCC: Indicates a display controller.
23 : 16	00h	RO	SUB_CLASS_CODE	When MGGC[1] = VD = 0b (default), this value is 00h. When MGGC[1] = VD = 0b or when MGGC[6:4] = GMS = 000b, this value is 80h.
15 : 8	00h	RO	PROGRAMMING_INTERFACE	PI: Indicates a display controller.
7 : 0	Refer to bit description	RO	REVISION_ID	Revision Identification Number: This is an 8-bit value that indicates the revision identification number for the device. For the B-0 Stepping, this value is 03h. For B-1 Stepping, this value is 05h.

Table 80. 0Ch: GVD.HDR – Header Type

Size: 32 bit		Default: 00000000h		Power Well: Core
Access	PCI Configuration		B:D:F 0:2:0	Offset Start: 0Ch Offset End:
	Message Bus		Port: 06h	Register Address: 03h
Bit Range	Default	Access	Acronym	Description
31 : 24	00h	RO	RESERVED	Reserved
23	0b	RO	MULTI_FUNCTION_STATUS	MFUNC: Integrated graphics is a single function.
22 : 16	00h	RO	HEADER_CODE	HDR: Indicates a type 0 header format.
15 : 0		RO	RESERVED	Reserved

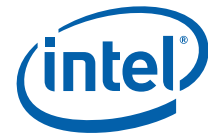

Table 81. 10h: GVD.MMADR – Memory Mapped Address Range

Size: 32 bit		Default: 00000000h		Power Well: Core
Access		PCI Configuration B:D:F 0:2:0		Offset Start: 10h Offset End:
		Message Bus Port: 06h		Register Address: 04h
Bit Range	Default	Access	Acronym	Description
31 : 20	000h	RW	BASE_ADDRESS	BA: Set by the OS, these bits correspond to address signals [31:20]. The GVD will compare the SCL address scldown3_address[31:20] with MMADR[31:20]. If there is a match, and PCICMDSTS[1] = MSE = 1 and the SCL command is either a MEMRD or MEMWR, the GVD will select the command and present it on the RMBus. The MMADR is to be used for register programming the GVD memory interface registers, the display controller registers, the graphics cluster (GFX) registers, the video decode (VED) registers, the video encode (VEC) registers, and the video processing block (VPB) registers. If the display controller registers don't assert claim, then GVD will report a miss on the SCL bus. For all other register address that are part of this address range, GVD will assert a hit on the SCL bus.
19 : 1	0000h	RO	RESERVED	Reserved
0	0b	RO	RESOURCE_TYPE	RTE: Indicates a request for memory space.

Table 82. 14h: GVD.GFX_IOBAR – I/O Base Address

Size: 32 bit		Default: 00000001h		Power Well: Core
Access		PCI Configuration B:D:F 0:2:0		Offset Start: 14h Offset End:
		Message Bus Port: 06h		Register Address: 05h
Bit Range	Default	Access	Acronym	Description
31 : 16	0000h	RO	RESERVED	Reserved
15 : 3	0000h	RW	BASE_ADDRESS	BA: Set by the OS, these bits correspond to address signals [15:3]. The GVD will compare the SCL address scldown3_address[15:3] with GFX_IOBAR[15:3]. If there is a match, and PCICMDSTS[0] = IOSE = 1 and the SCL command is either an IORD or IOWR, the GVD will select the command (i.e. issue a scldown3_hit). The GFX_IOBAR is to be used for register programming the GVD memory interface registers, the display controller registers, the graphics cluster (GFX) registers, the video decode (VED) registers, the video encode (VEC) registers, and the video processing block (VPB) registers using the indirect register access method. The GFX_IOBAR is to be used for GTT write on SCL using the indirect access method.
2 : 1	0h	RO	RESERVED	Reserved
0	1h	RO	RESOURCE_TYPE	Indicates a request for I/O space.



Table 83. 18h: GVD.GMADR – Graphics Memory Address Range

Size: 32 bit		Default: 00000000h		Power Well: Core
Access		PCI Configuration B:D:F 0:2:0		Offset Start: 18h Offset End:
		Message Bus Port: 06h		Register Address: 06h
Bit Range	Default	Access	Acronym	Description
31 : 29	0h	RW	BASE_ADDRESS	BA: Set by the OS, these bits correspond to address signals [31:28]. The GVD will compare the SCL address scldown3_address[31:29,28, or 27] with GMADR[31:29,28, or 27], respectively. (Whether the comparison is 31:29, 31:28 or 31:27 depends on the value of MSAC[17:16].) If there is a match, and MSE = 1 and the SCL command is either a MEMRD or MEMWR, the GVD will select the command (i.e. issue a scldown3_hit). The GMADR is to be used for the graphics cluster (GFX) tiled memory space.
28	0b	RWL	512_MB_ADDR ESS_MASK	M512M: This bit is either part of the Memory Base Address (RW) or part of the Address Mask (RO), depending on the value of MSAC.UAS. If this bit is used in the address comparison, the address space is limited to 256 MB.
27	0b	RWL	256_MB_ADDR ESS_MASK	M256M: This bit is either part of the Memory Base Address (RW) or part of the Address Mask (RO), depending on the value of MSAC.UAS. If this bit is used in the address comparison, the address space is limited to 128 MB.
26 : 1	0h	RO	RESERVED	Reserved
0	0b	RO	RESOURCE _TYPE_RTE	Indicates a request for memory space.

Table 84. 1Ch: GVD.GTTADR – Graphics Translation Table Address Range

Size: 32 bit		Default: 00000000h		Power Well: Core
Access		PCI Configuration B:D:F 0:2:0		Offset Start: 1Ch Offset End:
		Message Bus Port: 06h		Register Address: 07h
Bit Range	Default	Access	Acronym	Description
31 : 19	0h	RW	BASE_ADDRESS	BA: Set by the OS, these bits correspond to address signals [31:19]. The GVD will compare the SCL address scldown3_address[31:19,18, or 17] with GTTBAR[31:19,18, or 17], respectively. (Whether the comparison is 31:19, 31:18 or 31:17 depends on the value of MSAC[17:16].) If there is a match, and MSE = 1 and the SCL command is either a MEMRD or MEMWR, the GVD will select the command (i.e. issue a scldown3_hit). The GVD will then issue a memory read/write (via the LP arbiter RequestGB1 interface with Bunit). The address of the read/write will be an offset from Page Table Base Address[31:1] defined in MMIO register 02020h.
18	0b	RWL	512_KB_ADDR SS_MASK	M512K: This bit is either part of the GTT Base Address (RW) or part of the Address Mask (RO), depending on the value of MSAC.UAS. If this bit is used in the address comparison, the address space is limited to 256 kB.
17	0b	RWL	256_KB_ADDR SS_MASK	M256K: This bit is either part of the GTT Base Address (RW) or part of the Address Mask (RO), depending on the value of MSAC.UAS. If this bit is used in the address comparison, the address space is limited to 128 kB.
16 : 1	0h	RO	RESERVED	Reserved
0	0b	RO	BASE_ADDRESS	RTE: Indicates a request for memory space.

**Table 85. 2Ch: GVD.SSID – Subsystem Identifiers**

Size: 32 bit		Default: 00000000h		Power Well: Core
Access		PCI Configuration B:D:F 0:2:0		Offset Start: 2Ch Offset End:
		Message Bus Port: 06h		Register Address: 0Bh
Bit Range	Default	Access	Acronym	Description
31:0	0h	WOARnROAW	SUBSYSTEM_ID ENTIFIERS	The value in this field is programmed by the system BIOS. According to the PCI spec, only the BIOS can write it, and only once after reset. After the first write, this register becomes read-only. The content of this register may also be read (not written) from the Device 0 subsystem register address.

Table 86. 34h: GVD.CAPPOINT – Capabilities Pointer

Size: 32 bit		Default: 000000D0h		Power Well: Core
Access		PCI Configuration B:D:F 0:2:0		Offset Start: 34h Offset End:
		Message Bus Port: 06h		Register Address: 0Dh
Bit Range	Default	Access	Acronym	Description
31:8	000000h	RO	RESERVED	Reserved
7:0	D0h	RO	CAPABILITIES_ POINTER	The first item in the capabilities list is at address D0h.

Table 87. 3Ch: GVD.INTR – Interrupt

Size: 32 bit		Default: 00000100h		Power Well: Core
Access		PCI Configuration B:D:F 0:2:0		Offset Start: 3Ch Offset End:
		Message Bus Port: 06h		Register Address: 0Fh
Bit Range	Default	Access	Acronym	Description
31:16	0000h	RO	RESERVED	Reserved
15:8	01h	RO	INTERRUPT_PI N	IPIN: Value indicates which interrupt pin this device uses. This field is hard coded to 1h since the processor Device 2 is a single function device. The PCI spec requires that it use INTA#.
7:0	00h	RW	INTERRUPT_LI NE	ILIN: BIOS written value to communicate interrupt line routing information to the device driver.



Table 88. 50h: GVD.MGGC – Graphics Control

Size: 32 bit		Default: 00300000h		Power Well: Core
Access		PCI Configuration		B:D:F 0:2:0
		Message Bus		Port: 06h
				Offset Start: 50h Offset End:
				Register Address: 14h
Bit Range	Default	Access	Acronym	Description
31 : 23	0	RO	RESERVED	
22 : 20	011b	RW	GRAPHICS_MODE_SELECT	<p>GMS: This field is used to select the amount of memory pre-allocated to support the graphics device in VGA (non-linear) and Native (linear) modes. If graphics is disabled, this value must be programmed to 000h.</p> <p>000 = No memory pre-allocated. Graphics does not claim VGA cycles (Mem and IO), and CC.SCC is 80h.</p> <p>001 = DVMT (UMA) mode, 1 MB of memory pre-allocated for frame buffer</p> <p>010 = DVMT (UMA) mode, 4 MB of memory pre-allocated for frame buffer</p> <p>011 = DVMT (UMA) mode, 8 MB of memory pre-allocated for frame buffer</p> <p>100 = DVMT (UMA) mode, 16 MB of memory pre-allocated for frame buffer</p> <p>101 = DVMT (UMA) mode, 32 MB of memory pre-allocated for frame buffer</p> <p>110 = DVMT (UMA) mode, 48 MB of memory pre-allocated for frame buffer</p> <p>111 = DVMT (UMA) mode, 64 MB of memory pre-allocated for frame buffer</p> <p>When GMS not equal to 000 (and VD=0) the GVD will check if the SCL address scldown3_address[31:0] is in the VGA memory range. (The VGA memory range is A0000h to BFFFFh.) If there is a match and MSE = 1 and the SCL command is either a MEMRD or MEMWR, the GVD will initiate an RMDwvgamemen_cr cycle on the RMBus. If the RMBus returns a hit the GVD will select the command. As well, when 0 the GVD will check if scldown3_address[15:0] is one of the VGA IO register range. (The VGA IO range is 03B0h - 03BBh and 03C0h - 03DFh.) If there is a match and IOSE = 1 and the SCL command is either an IORD or IOWR, the GVD will initiate a (VGA) register cycle on the RMBus. If the RMBus returns a hit the GVD will select the command. When GMS is equal to 000, the GVD will not check if the SCL address is in the VGA memory range or in the VGA IO register address range. Also, when GMS is set to 3'b000, then CC[15:8] is changed to 8'h80 from 8'h00.</p>
19 : 18	0	RO	RESERVED	Reserved
17	0b	RW	VGA_DISABLE	<p>VD: When set, VGA memory or I/O cycles are not claimed, and CC.SCC is set to 80h. When cleared, VGA memory and I/O cycles are enabled, and CC.SCC is set to 00h.</p> <p>When 0 (and GMS not equal to 000), the GVD will check if the SCL address scldown3_address[31:0] is in the VGA memory range. (The VGA memory range is A0000h to BFFFFh.) If there is a match and MSE=1 and the SCL command is either a MEMRD or MEMWR, the GVD will initiate an RMDwvgamemen_cr cycle on the RMBus. If the RMBus returns a hit the GVD will select the command. As well, when 0 the GVD will check if scldown3_address[15:0] is one of the VGA IO register range. (The VGA IO range is 03B0h - 03BBh and 03C0h - 03DFh.) If there is a match and IOSE = 1 and the SCL command is either an IORD or IOWR, the GVD will initiate a (VGA) register cycle on the RMBus. If the RMBus returns a hit then the command will be claimed by the GVD. When 1, the GVD will not check if the SCL address is in the VGA memory range or in the VGA IO register address range. Also, when the field is set 1'b1 and GMS = 3'b000, then CC[15:8] is changed to 8'h80 from 8'h00.</p>
16 : 0	00000h	RO	RESERVED	Reserved

**Table 89. 5Ch: GVD.BSM – Base of Stolen Memory**

Size: 32 bit		Default: 00000000h		Power Well: Core
Access		PCI Configuration B:D:F 0:2:0		Offset Start: 5Ch Offset End:
		Message Bus Port: 06h		Register Address: 17h
Bit Range	Default	Access	Acronym	Description
31 : 20	000h	RW	BASE_OF_STOLEN_MEMORY	BSM: This register contains bits 31 to 20 of the base address of stolen DRAM memory. When the GVD receives a VGA memory request address[19:5] from the vrdunit or vrhunit, the GVD appends the base address BSM[31:20] to form the full physical address to send to the Bunit.
19 : 0	00000h	RO	RESERVED	Reserved

Table 90. 60h: GVD.MSAC – Multi Size Aperture Control

Size: 32 bit		Default: 00020000h		Power Well: Core
Access		PCI Configuration B:D:F 0:2:0		Offset Start: 60h Offset End:
		Message Bus Port: 06h		Register Address: 18h
Bit Range	Default	Access	Acronym	Description
31 : 18	0000h	RW	SCRATCH	Spare bits
17 : 16	10b	RW	UN_TRUSTED_APERTURE_SIZE_UAS	This register determines the size of the graphics memory aperture and untrusted space. by default the aperture size is 256 MB. Only BIOS writes this register based on address allocation efforts. Drivers may read this register to determine the correct aperture size. BIOS must restore this data upon S3 resume. The value in this field affects the size of the GMADR and the size of the GTTBAR that is formed and used by the GVD. 00 - Reserved. 01 - 512 MB. Bits 28 and 27 of GMADR are read-only, allowing 512 MB of address space to be mapped. The un-trusted GTT is 512 kB. 10 - 256 MB. Bit 28 is read-write and bit 27 of GMADR is read-only limiting the address space to 256 MB. The un-trusted GTT is 256 KB 11 - 128 MB. Bits 28 and 27 of GMADR are read-write limiting the address space to 128 MB. The un-trusted GTT is 128 KB.
15 : 0	0000h	RW	SCRATCH	Spare bits

Table 91. 90h: GVD.MSI_CAPID – Message Signaled Interrupts Capability ID and Control Register (Sheet 1 of 2)

Size: 32 bit		Default: 00000005h		Power Well: Core
Access		PCI Configuration B:D:F 0:2:0		Offset Start: 90h Offset End:
		Message Bus Port: 06h		Register Address: 24h
Bit Range	Default	Access	Acronym	Description
31 : 24	00h	RO	RESERVED	Reserved
23	0	RO	64_BIT_ADDRESS_CAPABLE	C64: 32-bit capable only.

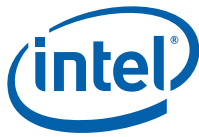

Table 91. 90h: GVD.MSI_CAPID – Message Signaled Interrupts Capability ID and Control Register (Sheet 2 of 2)

Size: 32 bit		Default: 00000005h		Power Well: Core
Access		PCI Configuration B:D:F 0:2:0		Offset Start: 90h Offset End:
		Message Bus Port: 06h		Register Address: 24h
Bit Range	Default	Access	Acronym	Description
22 : 20	000b	RW	MULTIPLE_MESSAGE_ENABLE	MME: This field is RW for software compatibility, but only a single message is ever generated.
19 : 17	000b	RO	MULTIPLE_MESSAGE_CAPABLE	MMC: This device is only single message capable.
16	0b	RW	MSI_ENABLE	MSIE: If set, MSI is enabled and traditional interrupts are not used to generate interrupts. PCICMDSTS.BME must be set for an MSI to be generated. When 0, blocks the sending of a MSI interrupt and permits the sending of a Message bus interrupt. (The interrupt status is not blocked from being reflected in the PCICMDSTS.IS bit.) When 1, permits sending of a MSI interrupt and blocks the sending of a Message bus interrupt. (The interrupt status is not blocked from being reflected in the PCICMDSTS.IS bit.)
15 : 8	00h	RO	POINTER_TO_NEXT_CAPABILITY	Indicates this is the last item in the list.
7 : 0	05h	RO	CAPABILITY_ID	CAPID: Indicates an MSI capability.

Table 92. 94h: GVD.MA – Message Address

Size: 32 bit		Default: 00000000h		Power Well: Core
Access		PCI Configuration B:D:F 0:2:0		Offset Start: 94h Offset End:
		Message Bus Port: 06h		Register Address: 25h
Bit Range	Default	Access	Acronym	Description
31 : 2	00000000h	RW	ADDRESS	MA: Lower 32-bits of the system specified message address, always DW aligned. When the GVD issues an MSI interrupt as a MEMWR on the SCL, the memory address corresponds to the value of this field.
1 : 0	00b	RO	RESERVED	Reserved

Table 93. 98h: GVD.MD – Message Data

Size: 32 bit		Default: 00000000h		Power Well: Core
Access		PCI Configuration B:D:F 0:2:0		Offset Start: 98h Offset End:
		Message Bus Port: 06h		Register Address: 26h
Bit Range	Default	Access	Acronym	Description
31 : 16	0000h	RO	RESERVED	Reserved
15 : 0	0000h	RW	DATA	MD: This 16-bit field is programmed by system software and is driven onto the lower word of data during the data phase of the MSI write transaction. When the GVD issues an MSI interrupt as a MEMWR on the SCL, the write data corresponds to the value of this field.

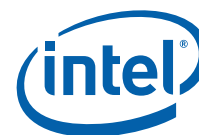

Table 94. B0h: GVD.VCID – Vendor Capability ID

Size: 32 bit		Default: 01070009h		Power Well: Core
Access		PCI Configuration B:D:F 0:2:0		Offset Start: B0h Offset End:
		Message Bus Port: 06h		Register Address: 2Ch
Bit Range	Default	Access	Acronym	Description
31 : 24	01h	RO	VERSION	VS: Identifies this as the first revision of the CAPID register definition.
23 : 16	07h	RO	LENGTH	LEN: This field has the value 07h to indicate the structure length (8 bytes).
15 : 8	00h	RO	NEXT_CAPABILITY_POINTER	If FD.MD is cleared, this reports 90h (MSI capability). If FD.MD is set, this reports 00h (last item in the list).
7 : 0	09h	RO	CAPABILITY_ID_CID	Identifies this as a vendor dependent capability pointers.

Table 95. B4h: GVD.VC – Vendor Capabilities

Size: 32 bit		Default: 00000000h		Power Well: Core
Access		PCI Configuration B:D:F 0:2:0		Offset Start: B4h Offset End:
		Message Bus Port: 06h		Register Address: 2Dh
Bit Range	Default	Access	Acronym	Description
31 : 0	0h	RO	RESERVED	Reserved

Table 96. C4h: GVD.FD – Functional Disable

Size: 32 bit		Default: C4h		Power Well: Core
Access		PCI Configuration B:D:F 0:2:0		Offset Start: C4h Offset End:
		Message Bus Port: 06h		Register Address: 31h
Bit Range	Default	Access	Acronym	Description
31 : 2	00000000h	RO	RESERVED	Reserved
1	0b	RW	MSI_DISABLE	MD: When set, the MSI capability pointer is not available - the item which points to the MSI capability (the power management capability), will instead indicate that this is the last item in the list.
0	0b	RW	FUNCTION_DISABLE	FD: When set, the function is disabled (configuration space is disabled). When set, the GVD stops accepting any new requests on the SCL bus including any new configuration cycle requests to clear this bit. Since the processor does not support a separate external PCI graphics card, this bit should never be set.

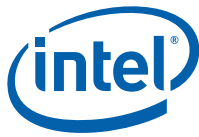

Table 97. D0h: GVD.PMCAP – Power Management Capabilities

Size: 32 bit		Default: 0022B001h		Power Well: Core
Access		PCI Configuration B:D:F 0:2:0		Offset Start: D0h Offset End:
		Message Bus Port: 06h		Register Address: 34h
Bit Range	Default	Access	Acronym	Description
31 : 27	00h	RO	PME_SUPPORT	PMES The graphics controller does not generate PME#.
26	0b	RO	D2_SUPPORT	D2S: The D2 power management state is not supported.
25	0b	RO	D1_SUPPORT	D1S: The D1 power management state is not supported.
24 : 22	000b	RO	RESERVED	Reserved
21	1b	RO	DEVICE_SPECIFIC_INITIALIZATION	Hardwired to 1 to indicate that special initialization of the graphics controller is required before generic class device driver is to use it.
20 : 19	00b	RO	RESERVED	Reserved
18 : 16	010b	RO	VERSION	VS: Indicates compliance with revision 1.1 of the PCI Power Management Specification.
15 : 8	B0h	RO	NEXT_POINTER	Indicates the next item in the capabilities list.
7 : 0	01h	RO	CAPABILITIES_ID	CAPID: SIG defines this ID is 01h for power management.

Table 98. D4h: GVD.PMCS – Power Management Control/Status

Size: 32 bit		Default: 00000000h		Power Well: Core
Access		PCI Configuration B:D:F 0:2:0		Offset Start: D4h Offset End:
		Message Bus Port: 06h		Register Address: 35h
Bit Range	Default	Access	Acronym	Description
31 : 2	00000000h	RO	RESERVED	Reserved
1 : 0	00b	RW	POWER_STATE_PS	In the processor, power management is implemented by writing to control registers in the Punit. This field may be programmed by the software driver, but no action is taken based on writing to this field.

Table 99. E0h: GVD.SWSMISCI – Software SMI or SCI (Sheet 1 of 2)

Size: 32 bit		Default: 00000000h		Power Well: Core
Access		PCI Configuration B:D:F 0:2:0		Offset Start: E0h Offset End:
		Message Bus Port: 06h		Register Address: 38h
Bit Range	Default	Access	Acronym	Description
31 : 16	0000h	RO	RESERVED	Reserved
15	0b	RW	SMI_OR_SCI_EVENT_SELECT	MCS: SMI or SCI event select. 0 = SMI 1 = SCI
14 : 1	0000h	RW	SOFTWARE_SCATCH_BITS	Used by driver to communicate information to SBIOS. No hardware functionality.

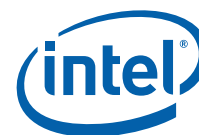

Table 99. E0h: GVD.SWSMISCI – Software SMI or SCI (Sheet 2 of 2)

Size: 32 bit		Default: 00000000h		Power Well: Core
Access		PCI Configuration B:D:F 0:2:0		Offset Start: E0h Offset End:
		Message Bus Port: 06h		Register Address: 38h
Bit Range	Default	Access	Acronym	Description
0	0b	RW	SMI_OR_SCI_EVENT	MCE: If MCS=1, setting this bit causes an SCI. If MCS=0, setting this bit causes an SMI. A 1 to 0, 0 to 0 or 1 to 1 transition of this bit does not trigger any events. The graphics driver writes to this register as a means to interrupt the SBIOS.

Table 100. E4h: GVD.ASLE – System Display Event Register

Size: 32 bit		Default: 00000000h		Power Well: Core
Access		PCI Configuration B:D:F 0:2:0		Offset Start: E4h Offset End:
		Message Bus Port: 06h		Register Address: 39h
Bit Range	Default	Access	Acronym	Description
31 :24	00h	RW	ASLE_SCRATCH_TRIGGER_3	AST3: The writing of this by field (byte) - even if just writing back the original contents - will trigger a display controller interrupt (when the memory interface register bits IER[0] = 1 and IMR[0] = 0). If written as part of a 16-bit or 32-bit write, only one interrupt is generated in common.
23 :16	00h	RW	ASLE_SCRATCH_TRIGGER_2	AST2: The writing of this by field (byte) - even if just writing back the original contents - will trigger a display controller interrupt (when the memory interface register bits IER[0] = 1 and IMR[0] = 0). If written as part of a 16-bit or 32-bit write, only one interrupt is generated in common.
15 :8	00h	RW	ASLE_SCRATCH_TRIGGER_1	AST1: The writing of this by field (byte) - even if just writing back the original contents - will trigger a display controller interrupt (when the memory interface register bits IER[0] = 1 and IMR[0] = 0). If written as part of a 16-bit or 32-bit write, only one interrupt is generated in common.
7 :0	00h	RW	ASLE_SCRATCH_TRIGGER_0	AST0: The writing of this by field (byte) - even if just writing back the original contents - will trigger a display controller interrupt (when the memory interface register bits IER[0] = 1 and IMR[0] = 0). If written as part of a 16-bit or 32-bit write, only one interrupt is generated in common.

Table 101. F4h: GVD.LBB – Legacy Backlight Brightness (Sheet 1 of 2)

Size: 32 bit		Default: 00000000h		Power Well: Core
Access		PCI Configuration B:D:F 0:2:0		Offset Start: F4h Offset End:
		Message Bus Port: 06h		Register Address: 39h
Bit Range	Default	Access	Acronym	Description
31 :24	00h	RW	SCRATCH_3	Software scratch byte 3. Any write to this byte, even writing back the same value read, will trigger GVD to send the contents of LEGACY_BACKLIGHT_BRIGHTNESS byte to the VSunit.



Table 101. F4h: GVD.LBB – Legacy Backlight Brightness (Sheet 2 of 2)

Size: 32 bit		Default: 00000000h		Power Well: Core
Access		PCI Configuration B:D:F 0:2:0		Offset Start: F4h Offset End:
		Message Bus Port: 06h		Register Address: 39h
Bit Range	Default	Access	Acronym	Description
23 : 16	00h	RW	SCRATCH_2	Software scratch byte 2. Any write to this byte, even writing back the same value read, will trigger GVD to send the contents of LEGACY_BACKLIGHT_BRIGHTNESS byte to the VSunit.
15 : 8	00h	RW	SCRATCH_1	Software scratch byte 1. Any write to this byte, even writing back the same value read, will trigger GVD to send the contents of LEGACY_BACKLIGHT_BRIGHTNESS byte to the VSunit.
7 : 0	00h	RW	LEGACY_BACKLIGHT_BRIGHTNESS	LBES: The value of zero is the lowest brightness setting and the value of 255 is the brightest. A write to this register will cause a flag to be set (LBES) in the PIPEBSTATUS register and cause an interrupt if Backlight Event in the PIPEBSTATUS register and cause an Interrupt if Backlight Event (LBEE) and Display B Event is enabled by software. The field value (byte) is forwarded by the GVD to the VSunit.

Table 102. FCh: GVD.ASL ASL – ASL Storage

Size: 32 bit		Default: 00000000h		Power Well: Core
Access		PCI Configuration B:D:F 0:2:0		Offset Start: FCh Offset End:
		Message Bus Port: 06h		Register Address: 3Fh
Bit Range	Default	Access	Acronym	Description
31 : 0	00000000h	RW	SCRATCH	This register provides a means for the BIOS to communicate with the driver. This definition of this scratch register is worked out in common between System BIOS and driver software. Storage for up to 6 devices is possible. For each device, the ASL control method requires two bits for <u>_DOD</u> (BIOS detectable yes or no, VGA/NonVGA), one bit for <u>_DGS</u> (enable/disable requested), and two bits for <u>DCS</u> (enabled now/disabled now, connected or not).

7.7.2 D3:F0 PCI Configuration Registers

Table 103. PCI Header (Sheet 1 of 2)

Start	End	Symbol	Register Name
00	03	ID	Identifiers
04	05	CMD	Command
06	07	STS	Device Status
08	08	RID	Revision Identification
09	0B	CC	Class Codes
0E	0E	HTYPE	Header Type
10	13	MMABR	Memory Mapped Base Address
14	17	IOBAR	I/O Base Address
2C	2F	SS	Subsystem Identifiers



Table 103. PCI Header (Sheet 2 of 2)

Start	End	Symbol	Register Name
34	35	CAP_PTR	Capabilities Pointer
3C	3D	INTR	Interrupt Information
58	5B	SSRW	Software Scratch Read Write
60	61	HSRW	Hardware Scratch Read Write
90	91	MID	Message Signaled Interrupts Capability
92	93	MC	Message Control
94	97	MA	Message Address
98	99	MD	Message Data
C4	C7	FD	Functional Disable
E0	E1	SWSCI_SMI	Software SCI/SMI
E4	E7	ASLE	System Display Event Register
F0	F1	GCR	Graphics Clock Ratio
F4	F7	LBB	Legacy Backlight Brightness

7.7.2.1 Offset 00h: ID – Identifiers

Table 104. Offset 00h: ID – Identifiers

Size: 32 bit		Default: 41088086h		Power Well: Core
Access		PCI Configuration B:D:F 0:3:0		Offset Start: 00h Offset End: 03h
Bit Range	Default	Access	Acronym	Description
31 : 16		RO	DID	Device Identification Number: Identifier assigned to the processor core/primary PCI device. The lower 3 bits of this register are determined by a fuse.
15 : 00	8086h	RO	VID	Vendor Identification Number: PCI standard identification for Intel.

7.7.2.2 Offset 04h: CMD – PCI Command

Table 105. Offset 04h: CMD – PCI Command (Sheet 1 of 2)

Size: 16 bit		Default: 0000h		Power Well: Core
Access		PCI Configuration B:D:F 0:3:0		Offset Start: 04h Offset End: 05h
Bit Range	Default	Access	Acronym	Description
15 : 11	00h		RSVD	Reserved
10	0	RW	ID	Interrupt Disable: This bit disables the device from asserting INTx_B. When cleared, enables the assertion of this device's INTx_B signal. When set, disables the assertion of this device's INTx_B signal.
09 : 03	0		RSVD	Reserved
02	0	RW	BME	Bus Master Enable: Enables the IGD to function as a PCI compliant master.
01	0	RW	MSE	Memory Space Enable: When set, accesses to this device's memory space is enabled.



Table 105. Offset 04h: CMD – PCI Command (Sheet 2 of 2)

Size: 16 bit		Default: 0000h		Power Well: Core
Access		PCI Configuration B:D:F 0:3:0		Offset Start: 04h Offset End: 05h
Bit Range	Default	Access	Acronym	Description
00	0	RW	IOSE	I/O Space Enable: When set, accesses to this device's I/O space is enabled.

7.7.2.3 Offset 06h: STS - PCI Status

Table 106. Offset 06h: STS - PCI Status

Size: 16 bit		Default: 0010h		Power Well: Core
Access		PCI Configuration B:D:F 0:3:0		Offset Start: 06h Offset End: 07h
Bit Range	Default	Access	Acronym	Description
15 : 05	0	RO	RSVD	Reserved
04	1	RO	CAP	Capability List: Indicates that the register at 34h provides an offset into PCI Configuration Space containing a pointer to the location of the first item in the list.
03	0	RO	IS	Interrupt Status: Reflects the state of the interrupt in the device in the graphics device.
02 : 00	000b	RO	RSVD	Reserved

7.7.2.4 Offset 08h: RID - Revision Identification

This value matches the revision ID register of the LPC bridge.

Table 107. Offset 08h: RID - Revision Identification

Size: 8 bit		Default: Refer to bit description		Power Well: Core
Access		PCI Configuration B:D:F 0:3:0		Offset Start: 08h Offset End: 08h
Bit Range	Default	Access	Acronym	Description
7 : 0	Refer to bit description	RO	RID	Revision ID: Refer to the <i>Intel® Atom™ Processor E6xx Series Specification Update</i> for the value of the Revision ID Register. For the B-0 Stepping, this value is 01h. For B-1 Stepping, this value is 02h.

7.7.2.5 Offset 09h: CC - Class Codes

Table 108. Offset 09h: CC - Class Codes (Sheet 1 of 2)

Size: 24 bit		Default: 00000000h		Power Well: Core
Access		PCI Configuration B:D:F 0:3:0		Offset Start: 09h Offset End: 0Bh
Bit Range	Default	Access	Acronym	Description
23 : 16	Refer to bit description	RO	BCC	Base Class Code: Indicates a display controller. For B-0 stepping, this value is 03h. For B-1 stepping, this value is 04h.



Table 108. Offset 09h: CC - Class Codes (Sheet 2 of 2)

Size: 24 bit		Default: 00000000h		Power Well: Core
Access		PCI Configuration B:D:F 0:3:0		Offset Start: 09h Offset End: 0Bh
Bit Range	Default	Access	Acronym	Description
15 : 08	00h/80h	RO	SCC	Sub-Class Code: When GC.VD is cleared, this value is 00h. When GC.VD is set, this value is 80h.
07 : 00	00h	RO	PI	Programming Interface: Indicates a display controller.

7.7.2.6 Offset 0Eh: HDR - Header Type

Table 109. Offset 0Eh: HDR - Header Type

Size: 8 bit		Default: 00000000h		Power Well: Core
Access		PCI Configuration B:D:F 0:3:0		Offset Start: 0Eh Offset End: 0Eh
Bit Range	Default	Access	Acronym	Description
07	0	RO	MFUNC	Multi Function Status: Integrated graphics is a single function.
06 : 00	00h	RO	HDR	Header Code: Indicates a type 0 header format.

7.7.2.7 Offset 10h: MMADR - Memory Mapped Base Address

This register requests allocation for the IGD registers and instruction ports. The allocation is for 512 KB.

Table 110. Offset 10h: MMADR - Memory Mapped Base Address

Size: 32 bit		Default: 00000000h		Power Well: Core
Access		PCI Configuration B:D:F 0:3:0		Offset Start: 10h Offset End: 13h
Bit Range	Default	Access	Acronym	Description
31 : 19	0000h	RW	BA	Base Address: Set by the OS, these bits correspond to address signals [31:19].
18 : 01	0000h	RO	RSVD	Reserved
00	0	RO	RTE	Resource Type: Indicates a request for memory space.



7.7.2.8 Offset 14h: IOBAR - I/O Base Address

This register provides the base offset of 8 bytes of I/O registers within this device. Access to I/O space is allowed in the D0 state when CMD.IOSE is set. Access is disallowed in states D1-D3 or if CMD.IOSE is cleared. Access to this space is independent of VGA functionality.

Table 111. Offset 14h: IOBAR - I/O Base Address

Size: 32 bit		Default: 00000001h		Power Well: Core
Access		PCI Configuration		B:D:F 0:3:0
Offset Start: 14h				Offset End: 17h
Bit Range	Default	Access	Acronym	Description
31 : 16	0000h	RO	RSVD	Reserved
15 : 03	0000h	RW	BA	Base Address: Set by the OS, these bits correspond to address signals [15:3].
02 : 01	00	RO	RSVD	Reserved
00	1	RO	RTE	Resource Type: Indicates a request for I/O space.

7.7.2.9 Offset 2Ch: SS - Subsystem Identifiers

This register matches the value written to the LPC bridge.

7.7.2.10 Offset 34h: CAP_PTR - Capabilities Pointer

Table 112. Offset 34h: CAP_PTR - Capabilities Pointer

Size: 8 bit		Default: D0h		Power Well: Core
Access		PCI Configuration		B:D:F 0:3:0
Offset Start: 34h				Offset End: 34h
Bit Range	Default	Access	Acronym	Description
07 : 00	D0h	RO	PTR	Pointer: The first item in the capabilities list is at address D0h.

7.7.2.11 Offset 3Ch: INTR - Interrupt Information

Table 113. Offset 3Ch: INTR - Interrupt Information

Size: 16 bit		Default: xx00h		Power Well: Core
Access		PCI Configuration		B:D:F 0:3:0
Offset Start: 3Ch				Offset End: 3Dh
Bit Range	Default	Access	Acronym	Description
15 : 08	Variable	RO	IPIN	Interrupt Pin: This value reflects the value of D02IP.GP in the LPC configuration space.
07 : 00	00h	RW	ILIN	Interrupt Line: Software written value to indicate which interrupt line (vector) the interrupt is connected to. No hardware action is taken on this bit.

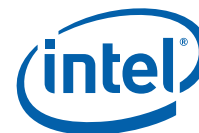

7.7.2.12 Offset 58h: SSRW - Software Scratch Read Write

Table 114. Offset 58h: SSRW - Software Scratch Read Write

Size: 32 bit		Default: 00000000h		Power Well: Core
Access		PCI Configuration B:D:F 0:3:0		Offset Start: 58h Offset End: 5Bh
Bit Range	Default	Access	Acronym	Description
31 : 00	00h	RO	S	Scratch: Scratchpad bits.

7.7.2.13 Offset 60h: HSRW - Hardware Scratch Read Write

Table 115. Offset 60h: HSRW - Hardware Scratch Read Write

Size: 16 bit		Default: 0000h		Power Well: Core
Access		PCI Configuration B:D:F 0:3:0		Offset Start: 60h Offset End: 61h
Bit Range	Default	Access	Acronym	Description
15 : 00	00h	RW	RSVD	Reserved

7.7.2.14 Offset 90h: MID - Message Signaled Interrupts Capability

Table 116. Offset 90h: MID - Message Signaled Interrupts Capability

Size: 16 bit		Default: 0005h		Power Well: Core
Access		PCI Configuration B:D:F 0:3:0		Offset Start: 90h Offset End: 91h
Bit Range	Default	Access	Acronym	Description
15 : 08	00	RO	NEXT	Pointer to Next Capability: Indicates this is the last item in the list.
07 : 00	05h	RO	ID	Capability ID: Indicates an MSI capability.

7.7.2.15 Offset 92h: MC - Message Control

Table 117. Offset 92h: MC - Message Control (Sheet 1 of 2)

Size: 16 bit		Default: 0000h		Power Well: Core
Access		PCI Configuration B:D:F 0:3:0		Offset Start: 92h Offset End: 93h
Bit Range	Default	Access	Acronym	Description
15 : 08	00h	RO		Reserved
07	000h	RO	C64	64-bit Address Capable: 32-bit capable only.
06 : 04	000h	RW	MME	Multiple Message Enable: This field is RW for software compatibility, but only a single message is ever generated.
03 : 01	000	RO	MMC	Multiple Message Capable: This device is only single message capable.



Table 117. Offset 92h: MC - Message Control (Sheet 2 of 2)

Size: 16 bit		Default: 0000h		Power Well: Core
Access		PCI Configuration		B:D:F 0:3:0
Offset Start: 92h Offset End: 93h				
Bit Range	Default	Access	Acronym	Description
00	0	RW	MSIE	MSI Enable: If set, MSI is enabled and traditional interrupts are not used to generate interrupts. CMD.BME must be set for an MSI to be generated. Note: Overall, a MSI interrupt is sent when the expression (IS & ~ID & BME & MSIE) changes from 0 to 1. Overall, a Message bus interrupt assert is sent when the expression (IS & ~ID & ~MSIE) changes from 0 to 1. The corresponding Message bus interrupt de-assert is sent when the expression (IS & ~ID & ~MSIE) changes from 1 to 0. See IS description for conditions that cause IS bit to be set to 1 and cleared to 0.

7.7.2.16 Offset 94h: MA - Message Address

Table 118. Offset 94h: MA - Message Address

Size: 32 bit		Default: 00000000h		Power Well: Core
Access		PCI Configuration		B:D:F 0:3:0
Offset Start: 94h Offset End: 97h				
Bit Range	Default	Access	Acronym	Description
31 : 02	0	RW	ADDR	Address: Lower 32-bits of the system specified message address, always DW aligned.
01 : 00	0h	RO	RSVD	Reserved.

7.7.2.17 Offset 98h: MD - Message Data

Table 119. Offset 98h: MD - Message Data

Size: 16 bit		Default: 0000h		Power Well: Core
Access		PCI Configuration		B:D:F 0:3:0
Offset Start: 98h Offset End: 99h				
Bit Range	Default	Access	Acronym	Description
15 : 00	0	RW	DATA	Data: This 16-bit field is programmed by system software and is driven onto the lower word of data during the data phase of the MSI write transaction

7.7.2.18 Offset C4h: FD - Functional Disable

Table 120. Offset C4h: FD - Functional Disable (Sheet 1 of 2)

Size: 32 bit		Default: 00000000h		Power Well: Core
Access		PCI Configuration		B:D:F 0:3:0
Offset Start: C4h Offset End: C7h				
Bit Range	Default	Access	Acronym	Description
31 : 02	0	RO	RSVD	Reserved
01	0h	RW	MD	MSI Disable: When set, the MSI capability pointer is not available - the item which points to the MSI capability (the power management capability), will instead indicate that this is the last item in the list.



Table 120. Offset C4h: FD - Functional Disable (Sheet 2 of 2)

Size: 32 bit		Default: 00000000h		Power Well: Core
Access		PCI Configuration B:D:F 0:3:0		Offset Start: C4h Offset End: C7h
Bit Range	Default	Access	Acronym	Description
00	0h	RW	D	Disable: When set, the function is disabled (configuration space is disabled).

7.7.2.19 Offset E0h: SWSCISMI - Software SCI/SMI

Table 121. Offset E0h: SWSCISMI - Software SCI/SMI

Size: 16 bit		Default: 0000h		Power Well: Core
Access		PCI Configuration B:D:F 0:3:0		Offset Start: E0h Offset End: E1h
Bit Range	Default	Access	Acronym	Description
15	0	RWO	MCS	SCI or SC Event Select: When set, SCI is selected. When cleared, SMI is selected.
14 : 01	0h	RW	SS	Software Scratch Bits: Used by software. No hardware functionality.
00	0h	RW	SWSCI	Software SCI Event: If MCS is set, setting this bit causes an SCI.

7.7.2.20 Offset E4h: ASLE - System Display Event Register

Table 122. Offset E4h: ASLE - System Display Event Register

Size: 32 bit		Default: N/A		Power Well: Core
Access		PCI Configuration B:D:F 0:3:0		Offset Start: E4h Offset End: E7h
Bit Range	Default	Access	Acronym	Description
31 : 24	N/A	RW	AST3	ASLE Scratch Trigger 3: When written, this scratch byte triggers an interrupt when IER bit 0 is enabled and IMR bit 0 is unmasked. If written as part of a 16-bit or 32-bit write, only one interrupt is generated in common.
23 : 16	N/A	RW	AST2	ASLE Scratch Trigger 2: Same definition as AST3.
15 : 08	N/A	RW	AST1	ASLE Scratch Trigger 1: Same definition as AST3.
07 : 00	N/A	RW	AST0	ASLE Scratch Trigger 0: Same definition as AST3.

7.7.2.21 Offset F0h: GCR - Graphics Clock Ratio

Table 123. Offset F0h: GCR - Graphics Clock Ratio (Sheet 1 of 2)

Size: 16 bit		Default: 0006h		Power Well: Core
Access		PCI Configuration B:D:F 0:3:0		Offset Start: F0h Offset End: F1h
Bit Range	Default	Access	Acronym	Description
15 : 04	0	RO	RSVD	Reserved

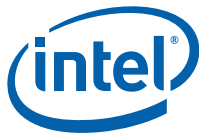

Table 123. Offset F0h: GCR - Graphics Clock Ratio (Sheet 2 of 2)

Size: 16 bit		Default: 0006h		Power Well: Core
Access		PCI Configuration		B:D:F 0:3:0
Offset Start: F0h		Offset End: F1h		
Bit Range	Default	Access	Acronym	Description
03 : 02	01	RW	GFX2X_GFX_RATIO	graphics 2x Clock to Graphics Clock Ratio: This field should be set by software to correspond with the gfx2xclkp (graphics 2x clock) to gfxclkp (graphics clock) ratio. The field is used to configure the graphics 2D processing engine. 00: gfx2xclkp to gfxclkp ratio is 1:1 01: gfx2xclkp to gfxclkp ratio is 2:1 10: Reserved 11: Reserved
01 : 00	10	RW	GCCR	Graphics Clock to Core Clock Ratio: Set by SW to correspond with the graphics clock to core clock ratio.

7.7.2.22 Offset F4h: LBB - Legacy Backlight Brightness

Table 124. Offset F4h: LBB - Legacy Backlight Brightness

Size: 32 bit		Default: N/A		Power Well: Core
Access		PCI Configuration		B:D:F 0:3:0
Offset Start: F4h		Offset End: F7h		
Bit Range	Default	Access	Acronym	Description
31 : 24	N/A	RW	LST3	LBPC Scratch Trigger 3: When written, triggers an interrupt when LBEE is enabled in Pipe B Status register and the Display B Event is enabled in IER and unmasked in IMR etc. If written as part of a 16-bit or 32-bit write, only one interrupt is generated in common.
23 : 16	N/A	RW	LST2	LBPC Scratch Trigger 2: Same definition as LST3.
15 : 08	N/A	RW	LST1	LBPC Scratch Trigger 1: Same definition as LST3.
07 : 00	N/A	RW	LBES	Legacy Backlight Brightness: The value of zero is the lowest brightness setting and 255 is the brightest. If field LBES is written as part of a 16-bit (word) or 32-bit (dword) write to LBB, this will cause a flag to be set (LBES) in the PIPEBSTATUS register and cause an interrupt if Backlight event in the PIPEBSTATUS register and cause an interrupt if Backlight Event (LBEE) and Display B Event is enabled by software. (If field LBES is written as a (one) byte write to LBB (i.e. if only least significant byte of LBB is written), no flag or interrupt will be generated.)

§ §



8.0 PCI Express*

8.1 Functional Description

There are four PCI Express* root ports available in the Intel® Atom™ Processor E6xx Series. They reside in device 23, 24, 25, and 26, and all take function 0. Port 0 is device 23, Port 1 is device 24, Port 2 is device 25 and Port 3 is device 26.

8.1.1 Interrupt Generation

The processor generates interrupts on behalf of hot plug and power management events, when enabled. These interrupts can either be pin-based or can be MSIs. When pin-based, the pin that is driven is based on the setting of the D23/24/25/26IP and D23/24/25/26IR registers. Table 125 summarizes interrupt behavior for Message Signal Interrupt (MSI) and wire-modes. In the table, “bits” refers to the hot plug and PME interrupt bits.

Table 125. MSI vs. PCI IRQ Actions

Interrupt Register	Wire-mode Action	MSI Action
All bits '0'	Wire inactive	No action
One or more bits set to '1'	Wire active	Send message
One or more bits set to '1,' new bit gets set to '1'	Wire active	Send message
One or more bits set to '1,' software clears some (but not all) bits	Wire active	Send message
One or more bits set to '1,' software clears all bits	Wire inactive	No action
Software clears one or more bits, and one or more bits are set on the same clock.	Wire active	Send message

8.1.2 Power Management

8.1.2.1 Sleep State Support

Software initiates the transition to S3/S4/S5 by performing a write to PM1C.SLPEN. After the write completion has been returned to the CPU, each root port will send a PME_Turn_Off message on its link. The device attached to the link eventually responds with a PME_TO_Ack followed by a PM_Enter_L23 DLLP to enter L23. When all ports links are in the L2/3 state, the power management control logic will proceed with the entry into S3/S4/S5.

8.1.2.2 Resuming from Suspended State

The root port can detect a wake event through the WAKE_B signal and wake the system. When the root port detects WAKE_B assertion, an internal signal is sent to the processor power management controller to cause the system to wake up. This internal message is not logged in any register, nor is an interrupt/GPE generated.

8.1.2.3 Device Initiated PM_PME Message

When the system has returned to S0, a device requesting service sends PM_PME messages until acknowledged by the processor. If RSTS.PS is cleared, the root port sets RSTS.PS, and logs the PME Requester ID into RSTS.RID. If RSTS.PS is set, the root port sets RSTS.PP and logs the PME Requester ID in a hidden register. When RSTS.PS is cleared, the root port sets RSTS.PS, clears RSTS.PP, and moves the requester ID from the hidden register into RSTS.RID.

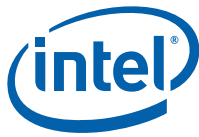

If RCTL.PIE is set, an interrupt is generated. If RCTL.PIE is not set, an SCI/SMI_B may be set. If RSTS.PS is set, and RCTL.PIE is later written from a '0' to a '1,' an interrupt is generated.

8.1.2.4 SMI/SCI Generation

To support power management on non PCI Express* aware operating systems, power management events can be routed to generate SCI, by setting MPC.PMCE. In addition, RTSTS.PS and PMCES.PME must be set and root port must be in D3hot power state (by setting PMCS.PS) to generate SCI. When set, a power management event causes SMSCS.PMCS to be set. BIOS workarounds for power management are supported by setting MPC.PMME. When set, power management events set SMSCS.PMMS, and SMI_B is generated. This bit is set regardless of whether interrupts or SCI are enabled. The SMI_B may occur concurrently with an interrupt or SCI.

8.1.3 Additional Clarifications

8.1.3.1 Non-Snoop Cycles Are Not Supported

The processor does not support No Snoop cycles on PCIe*. DCTL.ENS can never be set. Platform BIOS must disable generation of these cycles in all installed PCIe* devices. Generation of a No Snoop request by a PCIe* device may result in a protocol violation and lead to errors.

For example, a no-snoop read by a device may be returned by a snooped completion, and this attribute difference, a violation of the specification, will cause the device to ignore the completion.

8.2 PCI Express* Configuration Registers

8.2.1 PCI Type 1 Bridge Header

Table 126. PCI Type 1 Bridge Header (Sheet 1 of 2)

Register Name	Register Symbol	Register Start	Register End	Default Value	Access
Vendor Identification	VID	0	1	8086h	RO;
Device Identification	DID	2	3		RO;
PCI Command	CMD	4	5	0000h	RO; RW;
PCI Status	PSTS	6	7	0010h	RO; RWC;
Revision Identification	RID	8	8	01h (for B-0 Stepping) 02h (for B-1 Stepping)	RO;
Class Code	CC	9	B	060400h	RO;
Cache Line Size	CLS	C	C	00h	RW;
Header Type	HTYPE	E	E	01h	RO;
Primary Bus Number	PBN	18	18	00h	RW;
Secondary Bus Number	SCBN	19	19	00h	RW;

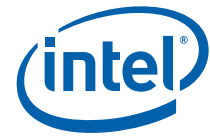

Table 126. PCI Type 1 Bridge Header (Sheet 2 of 2)

Register Name	Register Symbol	Register Start	Register End	Default Value	Access
Subordinate Bus Number	SBBN	1A	1A	00h	RW;
I/O Base Address	IOBASE	1C	1C	00h	RW; RO;
I/O Limit Address	IOLIMIT	1D	1D	00h	RW; RO;
Secondary Status	SSTS	1E	1F	0000h	RWC; RO;
Memory Base Address	MB	20	21	0000h	RW;
Memory Limit Address	ML	22	23	0000h	RW;
Prefetchable Memory Base Address	PMB	24	25	0000h	RW;
Prefetchable Memory Limit Address	PML	26	27	0000h	RW;
Capabilities Pointer	CAPP	34	34	40h	RO;
Interrupt Line	ILINE	3C	3C	00h	RW;
Interrupt Pin	IPIN	3D	3D	01h	RO;
Bridge Control	BCTRL	3E	3F	0000h	RO; RW;

8.2.1.1 VID — Vendor Identification

This register combined with the Device Identification register uniquely identifies any PCI device.

Table 127. Offset 00h: VID — Vendor Identification

Size: 16 bit		Default: 8086h		Power Well: Core
Access		PCI Configuration B:D:F 0:23-26:0		Offset Start: 0h Offset End: 1h
Bit Range	Default	Access	Acronym	Description
15 : 00	8086h	RO	VID1	Vendor Identification: PCI standard identification for Intel.

8.2.1.2 DID — Device Identification

This register combined with the Vendor Identification register uniquely identifies any PCI device.



Table 128. Offset 02h: DID — Device Identification

Size: 16 bit		Default:		Power Well: Core
Access		PCI Configuration		B:D:F 0:23-26:0
Offset Start: 2h Offset End: 3h				
Bit Range	Default	Access	Acronym	Description
15 : 00		RO	DID(UB)	Device Identification Number: Identifier assigned to the device (virtual PCI-to-PCI bridge) PCIe* Device 23 = 8184h PCIe* Device 24 = 8185h PCIe* Device 25 = 8180h PCIe* Device 26 = 8181h

8.2.1.3 CMD — PCI Command

Table 129. Offset 04h: CMD — PCI Command

Size: 16 bit		Default: 0000h		Power Well: Core
Access		PCI Configuration		B:D:F 0:23-26:0
Offset Start: 4h Offset End: 5h				
Bit Range	Default	Access	Acronym	Description
15 : 11	00h	RO	RSVD	Reserved
10	0b	RW	ID	Interrupt Disable: This disables pin-based INTx_B interrupts on enabled hot plug and power management events. When set, internal INTx_B messages will not be generated. When cleared, internal INTx_B messages are generated if there is an interrupt for hot plug or power management. This bit does not effect interrupt forwarding from devices connected to the root port. Assert_INTX and Deassert_INTX messages will still be forwarded to the internal interrupt controllers if this bit is set.
09	0b	RO	RSVD	Reserved
08	0b	RW	SEE	SERR_B Enable: When set, this enables the root port to generate SERR_B when PSTS.SSE is set.
07 : 03	00000b	RO	RSVD	Reserved
02	0b	RW	BME	Bus Master Enable: When set, allows the root port to forward cycles onto the backbone from a PCI Express* device. When cleared, all cycles from the device are master aborted.
01	0b	RW	MSE	Memory Space Enable: When set, memory cycles within the range specified by the memory base and limit registers can be forwarded to the PCI Express* device. When cleared, these memory cycles are master aborted on the backbone.
00	0b	RW	IOSE	I/O Space Enable: When set, I/O cycles within the range specified by the I/O base and limit registers can be forwarded to the PCI Express* device. When cleared, these cycles are master aborted on the backbone.

8.2.1.4 PSTS — Primary Status

This register reports the occurrence of error conditions associated with the primary side of the “virtual” Host-PCI Express* bridge embedded within the processor.



Table 130. Offset 06h: PSTS — Primary Status

Size: 16 bit		Default: 0010h		Power Well: Core
Access		PCI Configuration B:D:F 0:23-26:0		Offset Start: 6h Offset End: 7h
Bit Range	Default	Access	Acronym	Description
15	0b	RO	RSVD	Reserved
14	0b	RWC	SSE	Signaled System Error: This bit is set when this device sends an SERR due to detecting an ERR_FATAL or ERR_NONFATAL condition and the SERR Enable bit in the Command register is '1.' Both received (if enabled by BCTRL1[1]) and internally detected error messages do not effect this field.
13 : 05	000000 000b	RO	RSVD	Reserved
04	1b	RO	CLIST	Capabilities List: Indicates the presence of a capabilities list
03	0b	RO	IS	Interrupt Status: Indicates status of hot plug and power management interrupts on the root port that result in INTx_B message generation. This bit is set regardless of the state of CMD.ID.
02 : 00	000b	RO	RSVD	Reserved

8.2.1.5 RID — Revision Identification

This register contains the revision number of the device. These bits are read only and writes to this register have no effect.

Table 131. Offset 08h: RID — Revision Identification

Size: 8 bit		Default: Refer to bit description		Power Well: Core
Access		PCI Configuration B:D:F 0:23-26:0		Offset Start: 8h Offset End: 8h
Bit Range	Default	Access	Acronym	Description
07 : 00	Refer to bit description	RO	RID1	Revision Identification Number: This is an 8-bit value that indicates the revision identification number for the device. For the B-0 Stepping, this value is 01h. For B-1 Stepping, this value is 02h.

8.2.1.6 CC — Class Code

This register identifies the basic function of the device, a more specific sub-class, and a register-specific programming interface.

Table 132. Offset 09h: CC — Class Code

Size: 24 bit		Default: 060400h		Power Well: Core
Access		PCI Configuration B:D:F 0:23-26:0		Offset Start: 9h Offset End: Bh
Bit Range	Default	Access	Acronym	Description
23 : 16	06h	RO	BCC	Base Class Code: This indicates the base class code for this device. This code has the value 06h, indicating a Bridge device.
15 : 08	04h	RO	SUBCC	Sub-Class Code: This indicates the sub-class code for this device. The code is 04h indicating a PCI-to-PCI bridge.
07 : 00	00h	RO	PI	Programming Interface: This indicates the programming interface of this device. This value does not specify a particular register set layout and provides no practical use for this device.



8.2.1.7 CLS — Cache Line Size

Table 133. Offset 0Ch: CLS — Cache Line Size

Size: 8 bit		Default: 00h		Power Well: Core
Access		PCI Configuration		B:D:F 0: 23-26:0
Offset Start: Ch		Offset End: Ch		
Bit Range	Default	Access	Acronym	Description
07 : 00	00h	RW	CLS	Cache Line Size: Implemented by PCI Express* devices as a read-write field for legacy compatibility purposes but has no impact on any PCI Express* device functionality.

8.2.1.8 HTYPE — Header Type

This register identifies the header layout of the configuration space. No physical register exists at this location.

Table 134. Offset 0Eh: HTYPE — Header Type

Size: 8 bit		Default: 01h		Power Well: Core
Access		PCI Configuration		B:D:F 0: 23-26:0
Offset Start: Eh		Offset End: Eh		
Bit Range	Default	Access	Acronym	Description
07 : 00	01h	RO	HDR	Header Type Register: Returns 01h to indicate that this is a single function device with a bridge header layout.

8.2.1.9 PBN — Primary Bus Number

This register identifies that this “virtual” Host-PCI Express* bridge is connected to PCI bus #0.

Table 135. Offset 18h: PBN — Primary Bus Number

Size: 8 bit		Default: 00h		Power Well: Core
Access		PCI Configuration		B:D:F 0: 23-26:0
Offset Start: 18h		Offset End: 18h		
Bit Range	Default	Access	Acronym	Description
07 : 00	00h	RW	PBN	Primary Bus Number: Configuration software typically programs this field with the number of the bus on the primary side of the bridge. Since the device is an internal device, its primary bus is always 0.

8.2.1.10 SCBN — Secondary Bus Number

This register identifies the bus number assigned to the second bus side of the “virtual” bridge, in other words, to the PCI Express* device. This number is programmed by the PCI configuration software to allow mapping of configuration cycles to the PCI Express* device.



Table 136. Offset 19h: SCBN — Secondary Bus Number

Size: 8 bit		Default: 00h		Power Well: Core
Access		PCI Configuration B:D:F 0:23-26:0		Offset Start: 19h Offset End: 19h
Bit Range	Default	Access	Acronym	Description
07 : 00	00h	RW	SCBN	Secondary Bus Number: This field is programmed by configuration software with the bus number assigned to the PCI Express* device.

8.2.1.11 SBBN — Subordinate Bus Number

This register identifies the subordinate bus (if any) that resides at the level below the PCI Express* device. This number is programmed by the PCI configuration software to allow mapping of configuration cycles to the PCI Express* device.

Table 137. Offset 1Ah: SBBN — Subordinate Bus Number

Size: 8 bit		Default: 00h		Power Well: Core
Access		PCI Configuration B:D:F 0:23-26:0		Offset Start: 1Ah Offset End: 1Ah
Bit Range	Default	Access	Acronym	Description
07 : 00	00h	RW	SBBN	Subordinate Bus Number: This register is programmed by configuration software with the number of the highest subordinate bus that lies behind the device bridge. When only a single PCI device resides on the segment, this register will contain the same value as the SCBN register.

8.2.1.12 IOBASE — I/O Base Address

This register controls the CPU to PCI Express* I/O access routing based on the following formula: IO_BASE = < address =< IO_LIMIT. Only the upper four bits are programmable. For the purpose of address decode, address bits A[11:0] are treated as 0. Thus, the bottom of the defined I/O address range will be aligned to a 4 kB boundary.

Table 138. Offset 1Ch: IOBASE — I/O Base Address

Size: 8 bit		Default: 00h		Power Well: Core
Access		PCI Configuration B:D:F 0:23-26:0		Offset Start: 1Ch Offset End: 1Ch
Bit Range	Default	Access	Acronym	Description
07 : 04	0h	RW	IOBA	I/O Base Address: I/O Base bits corresponding to address lines 15:12 for 4 kB alignment. Bits 11:0 are assumed to be padded to 000h. The BIOS must not set this register to 00h; otherwise, 0CF8h/0CFCh accesses will be forwarded to the PCI Express* hierarchy associated with this device.
03 : 00	0h	RO	IOBC	I/O Base Address Capability: The bridge does not support 32-bit I/O addressing.

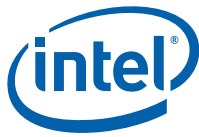

8.2.1.13 IOLIMIT — I/O Limit Address

This register controls the CPU to PCI Express* I/O access routing based on the following formula: IO_BASE =< address =< IO_LIMIT. Only the upper four bits are programmable. For the purpose of address decode, address bits A[11:0] are assumed to be FFFh. Thus, the top of the defined I/O address range will be at the top of a 4 kB aligned address block.

Table 139. Offset 1Dh: IOLIMIT — I/O Limit Address

Size: 8 bit		Default: 00h		Power Well: Core
Access		PCI Configuration		B:D:F 0:23-26:0
Offset Start: 1Dh		Offset End: 1Dh		
Bit Range	Default	Access	Acronym	Description
07 : 04	0h	RW	IOLA	I/O Address Limit: I/O Base bits corresponding to address lines 15:12 for 4 kB alignment. Bits 11:0 are assumed to be padded to FFFh. Devices between this upper limit and IOBASE will be passed to the PCI Express* hierarchy associated with this device.
03 : 00	0h	RO	IOLC	I/O Limit Address Capability: Indicates that the bridge does not support 32-bit I/O addressing.

8.2.1.14 SSTS — Secondary Status

SSTS is a 16-bit status register that reports the occurrence of error conditions associated with secondary side of the “virtual” PCI-to-PCI bridge embedded within the processor.

Table 140. Offset 1Eh: SSTS — Secondary Status (Sheet 1 of 2)

Size: 16 bit		Default: 0000h		Power Well: Core
Access		PCI Configuration		B:D:F 0:23-26:0
Offset Start: 1Eh		Offset End: 1Fh		
Bit Range	Default	Access	Acronym	Description
15	0b	RWC	DPE	Detected Parity Error: This bit is set by the Secondary Side for a Type 1 Configuration Space header device whenever it receives a Poisoned TLP, regardless of the state of the Parity Error Response Enable bit in the Bridge Control Register.
14	0b	RWC	RSE	Received System Error: This bit is set when the Secondary Side for a Type 1 configuration space header device receives an ERR_FATAL or ERR_NONFATAL.
13	0b	RWC	RMA	Received Master Abort: This bit is set when the Secondary Side for Type 1 Configuration Space Header Device (for requests initiated by the Type 1 Header Device itself) receives a Completion with Unsupported Request Completion Status.
12	0b	RWC	RTA	Received Target Abort: This bit is set when the Secondary Side for Type 1 Configuration Space Header Device (for requests initiated by the Type 1 Header Device itself) receives a Completion with Completer Abort Completion Status.
11	0b	RO	STA	Signaled Target Abort: Not applicable or implemented — hardwired to 0. The processor does not generate Target Aborts (the processor will never complete a request using the Completer Abort Completion status).
10 : 09	00b	RO	SDTS	Secondary DEVSEL_B Timing Status: Reserved per PCI Express* Base Specification
08	0b	RWC	DPD	Data Parity Error Detected: When set, this indicates that the MCH received across the link (upstream) a Read Data Completion Poisoned TLP (EP=1). This bit can only be set when the Parity Error Enable bit BCTRL.PERE in the Bridge Control register is set.

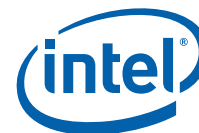

Table 140. Offset 1Eh: SSTS — Secondary Status (Sheet 2 of 2)

Size: 16 bit		Default: 0000h		Power Well: Core
Access		PCI Configuration B:D:F 0:23-26:0		Offset Start: 1Eh Offset End: 1Fh
Bit Range	Default	Access	Acronym	Description
07 : 00	00000000b	RO	RSVD	Reserved

8.2.1.15 MB — Memory Base Address

Accesses that are within the ranges specified in this register and the ML register will be sent to the attached device if the Memory Space Enable bit of PCICMD is set. Accesses from the attached device that are outside the ranges specified will be forwarded to the internal processor if the Bus Master Enable bit of PCICMD is set.

Table 141. Offset 20h: MB — Memory Base Address

Size: 16 bit		Default: 0000h		Power Well: Core
Access		PCI Configuration B:D:F 0:23-26:0		Offset Start: 20h Offset End: 21h
Bit Range	Default	Access	Acronym	Description
15 : 04	000h	RW	MB	Memory Base: These bits are compared with bits 31:20 of the incoming address to determine the lower 1 MB aligned value of the range.
03 : 00	0h	RO	RSVD	Reserved

8.2.1.16 ML — Memory Limit Address

Table 142. Offset 22h: ML — Memory Limit Address

Size: 16 bit		Default: 0000h		Power Well: Core
Access		PCI Configuration B:D:F 0:23-26:0		Offset Start: 22h Offset End: 23h
Bit Range	Default	Access	Acronym	Description
15 : 04	000h	RW	ML	Memory Limit: These bits are compared with bits 31:20 of the incoming address to determine the upper 1 MB aligned value of the range.
03 : 00	0h	RO	RSVD	Reserved

8.2.1.17 PMB — Prefetchable Memory Base Address

This register controls the CPU to PCI Express* prefetchable memory access routing based on the following formula: $PREFETCHABLE_MEMORY_BASE = \langle address \rangle = \langle PREFETCHABLE_MEMORY_LIMIT \rangle$. The upper 12 bits of this register are read/write and correspond to address bits A[31:20] of the 32-bit address. This register must be initialized by the configuration software. For the purpose of address decode, address bits A[19:0] are assumed to be 0. Thus, the bottom of the defined memory address range will be aligned to a 1 MB boundary.

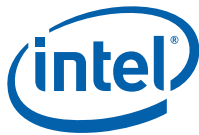

Table 143. Offset 24h: PMB — Prefetchable Memory Base Address

Size: 16 bit		Default: 0000h		Power Well: Core
Access		PCI Configuration B:D:F 0:23-26:0		Offset Start: 24h Offset End: 25h
Bit Range	Default	Access	Acronym	Description
15 : 04	000h	RW	PMB	Prefetchable Memory Base Address: This corresponds to A[31:20] of the lower limit of the memory range that will be passed to PCI Express*.
03 : 00	0h	RW	RSVD	Reserved

8.2.1.18 PML — Prefetchable Memory Limit Address

This register controls the CPU to PCI Express* prefetchable memory access routing based on the following formula: $PREFETCHABLE_MEMORY_BASE = \langle address = \langle PREFETCHABLE_MEMORY_LIMIT$. The upper 12 bits of this register are read/write and correspond to address bits A[31:20] of the 32-bit address. This register must be initialized by the configuration software. For the purpose of address decode, address bits A[19:0] are assumed to be FFFFh. Thus, the top of the defined memory address range will be at the top of a 1 MB aligned memory block. Note that prefetchable memory range is supported to allow segregation by the configuration software between the memory ranges that must be defined as UC and the ones that can be designated as USWC (in other words, prefetchable) from the CPU perspective.

Table 144. Offset 26h: PML — Prefetchable Memory Limit Address

Size: 16 bit		Default: 0000h		Power Well: Core
Access		PCI Configuration B:D:F 0:23-26:0		Offset Start: 26h Offset End: 27h
Bit Range	Default	Access	Acronym	Description
15 : 04	000h	RW	PML	Prefetchable Memory Address Limit: This corresponds to A[31:20] of the upper limit of the address range passed to PCI Express*.
03 : 00	0h	RW	RSVD	Reserved

8.2.1.19 CAPP — Capabilities Pointer

The capabilities pointer provides the address offset to the location of the first entry in this device's linked list of capabilities.

Table 145. Offset 34h: CAPP — Capabilities Pointer

Size: 8 bit		Default: 40h		Power Well: Core
Access		PCI Configuration B:D:F 0:23-26:0		Offset Start: 34h Offset End: 34h
Bit Range	Default	Access	Acronym	Description
07 : 00	40h	RO	PTR	First Capability: The first capability in the list is the Subsystem ID and Subsystem Vendor ID Capability.

8.2.1.20 ILINE — Interrupt Line

This register contains interrupt line routing information. The device itself does not use this value, rather it is used by device drivers and operating systems to determine priority and vector information.

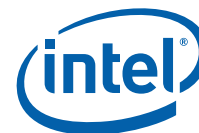

Table 146. Offset 3Ch: ILINE — Interrupt Line

Size: 8 bit		Default: 00h		Power Well: Core
Access		PCI Configuration B:D:F 0:23-26:0		Offset Start: 3Ch Offset End: 3Ch
Bit Range	Default	Access	Acronym	Description
07 : 00	00h	RW	ILINE	Interrupt Line: This software written value indicates to which interrupt line (vector) the interrupt is connected. No hardware action is taken on this register.

8.2.1.21 IPIN — Interrupt Pin

This register specifies which interrupt pin this device uses.

Table 147. Offset 3Dh: IPIN — Interrupt Pin

Size: 8 bit		Default: 01h		Power Well: Core
Access		PCI Configuration B:D:F 0:23-26:0		Offset Start: 3Dh Offset End: 3Dh
Bit Range	Default	Access	Acronym	Description
07 : 00	01h	RO	IPIN	Interrupt Pin (IPIN): This indicates the interrupt pin driven by the root port. At reset, this register takes on the following values, which reflect the reset state of the D23/24/25/26IP register in chipset configuration space: Port Bits[15:12] Bits[11:08] 0 0h D23IP.P11P 1 0h D24IP.P11P 2 0h D25IP.P11P 3 0h D26IP.P11P The value that is programmed into Interrupt Pin Configuration register is always reflected in this register.

8.2.1.22 BCTRL — Bridge Control

This register provides extensions to the PCICMD1 register that are specific to PCI-to-PCI bridges. The BCTRL provides additional control for the secondary interface as well as some bits that effect the overall behavior of the “virtual” Host-PCI Express* bridge embedded within the processor, for example, VGA compatible address ranges mapping.

Table 148. Offset 3Eh: BCTRL — Bridge Control (Sheet 1 of 2)

Size: 16 bit		Default: 0000h		Power Well: Core
Access		PCI Configuration B:D:F 0:23-26:0		Offset Start: 3Eh Offset End: 3Fh
Bit Range	Default	Access	Acronym	Description
15 : 12	0h	RO	RSVD	Reserved
11	0b	RO	DTSE	Discard Timer SERR_B Enable: Reserved per PCI Express* spec.
10	0b	RO	DTS	Discard Timer Status: Reserved per PCI Express* spec.
09	0b	RO	SDT	Secondary Discard Timer: Reserved per PCI Express* spec.
08	0b	RO	PDT	Primary Discard Timer: Reserved per PCI Express* spec.
07	0b	RO	FBE	Fast Back to Back Enable: Reserved per PCI Express* spec.
06	0b	RW	SBR	Secondary Bus Reset: This triggers a Hot Reset on the PCI Express* port.

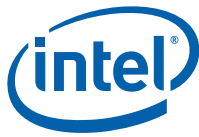

Table 148. Offset 3Eh: BCTRL — Bridge Control (Sheet 2 of 2)

Size: 16 bit		Default: 0000h		Power Well: Core
Access		PCI Configuration		Offset Start: 3Eh Offset End: 3Fh
		B:D:F 0:23-26:0		
Bit Range	Default	Access	Acronym	Description
05	0b	RO	MAM	Master Abort Mode: Reserved per PCI Express* spec.
04	0b	RW	V16	VGA 16-Bit Decode: When set, this indicates that the I/O aliases of the VGA range (see BCTRL.VE definition below) are not enabled and only the base I/O ranges can be decoded.
03	0b	RW	VE	VGA Enable: When set, the following ranges will be claimed off the backbone by the root port: <ul style="list-style-type: none"> Memory ranges A0000h-BFFFFh I/O ranges 3B0h–3BBh and 3C0h–3DFh, and all aliases of bits 15:10 in any combination of 1s
02	0b	RW	IE	ISA Enable: This bit only applies to I/O addresses that are enabled by the I/O Base and I/O Limit registers and are in the first 64 kB of PCI I/O space. If this bit is set, the root port will block any forwarding from the backbone to the device of I/O transactions addressing the last 768 bytes in each 1 kB block (offsets 100h to 3FFh).
01	0b	RW	SE	SERR_B Enable: When set, ERR_COR, ERR_NONFATAL, and ERR_FATAL messages received are forwarded to the backbone. When cleared, they are not.
00	0b	RW	PERE	Parity Error Response Enable: When set, poisoned write TLPs and completions indicating poisoned TLPs will set the SSTS.DPD.

8.2.2 Root Port Capability Structure

The following registers follow the PCI Express* capability list structure as defined in the PCI Express* specification, to indicate the capabilities of the root interconnect.

Table 149. Root Port Capability Structure

Start	End	Symbol	Register Name
42	43	XCAP	PCI Express* Capabilities
44	47	DCAP	Device Capabilities
48	49	DCTL	Device Control
4A	4B	DSTS	Device Status
4C	4F	LCAP	Link Capabilities
50	51	LCTL	Link Control
52	53	LSTS	Link Status
54	57	SLCAP	Slot Capabilities
58	59	SLCTL	Slot Control
5A	5B	SLSTS	Slot Status
5C	5D	RCTL	Root Control
5E	5F	RCAP	Root Capabilities
60	63	RSTS	Root Status
64	65	LCTL2	Link Control 2
66	67	LSTS2	Link Status 2



8.2.2.1 CLIST — Capabilities List

Table 150. Offset 40h: CLIST — Capabilities List

Size: 16 bit		Default: 9010h		Power Well: Core
Access		PCI Configuration B:D:F 0:23-26:0		Offset Start: 40h Offset End: 41h
Bit Range	Default	Access	Acronym	Description
15 : 08	90h	RO	NEXT	Next Capability: Value of 90h indicates the location of the next pointer.
07 : 00	10h	RO	CID	Capability ID: This indicates this is a PCI Express* capability.

8.2.2.2 XCAP — PCI Express* Capabilities

Table 151. Offset 42h: XCAP — PCI Express* Capabilities

Size: 16 bit		Default: 0041h		Power Well: Core
Access		PCI Configuration B:D:F 0:23-26:0		Offset Start: 42h Offset End: 43h
Bit Range	Default	Access	Acronym	Description
15 : 14	0h	RO	RSVD	Reserved
13 : 09	0h	RO	IMN	Interrupt Message Number: The processor does not have multiple MSI interrupt numbers.
08	0b	RWO	SI	Slot Implemented: This indicates whether the root port is connected to a slot. Slot support is platform-specific. The BIOS programs this field, and it is maintained until a platform reset.
07 : 04	4h	RO	DT	Device/Port Type: This indicates this is a PCI Express* root port.
03 : 00	1h	RO	CV	Capability Version: This indicates PCI Express* 1.0a.

8.2.2.3 DCAP — Device Capabilities

Table 152. Offset 44h: DCAP — Device Capabilities (Sheet 1 of 2)

Size: 32 bit		Default: 00008FC0h		Power Well: Core
Access		PCI Configuration B:D:F 0:23-26:0		Offset Start: 44h Offset End: 47h
Bit Range	Default	Access	Acronym	Description
31 : 28	0h	RO	RSVD	Reserved
27 : 26	00b	RO	CSPS	Captured Slot Power Limit Scale: Not supported
25 : 18	0h	RO	CSPV	Captured Slot Power Limit Value: Not supported
17 : 16	00b	RO	RSVD	Reserved
15	1b	RO	RBER	Role-based Error Reporting: Indicates that this device implements the functionality defined in the Error Reporting ECN for the PCI Express* 1.0a specification
14	0b	RO	PIP	Power Indicator Present: This indicates that no power indicator is present on the root port.
13	0b	RO	AIP	Attention Indicator Present: This indicates that no attention indicator is present on the root port.
12	0b	RO	ABP	Attention Button Present: This indicates that no attention button is present on the root port.



Table 152. Offset 44h: DCAP — Device Capabilities (Sheet 2 of 2)

Size: 32 bit		Default: 00008FC0h		Power Well: Core
Access		PCI Configuration		B:D:F 0:23-26:0
Offset Start: 44h		Offset End: 47h		
Bit Range	Default	Access	Acronym	Description
11 : 09	111b	RO	E1AL	Endpoint L1 Acceptable Latency: This indicates more than 4 μ s. This field essentially has no meaning for root ports since root ports are not endpoints.
08 : 06	111b	RO	EOAL	Endpoint L0 Acceptable Latency: This indicates more than 64 μ s. This field essentially has no meaning for root ports since root ports are not endpoints.
05	0b	RO	ETFS	Extended Tag Field Supported: This bit indicates that 5-bit tag fields are supported.
04 : 03	00b	RO	PFS	Phantom Functions Supported: No phantom functions supported
02 : 00	000b	RO	MPS	Max Payload Size Supported: This indicates that the maximum payload size supported is 128B.

8.2.2.4 DCTL — Device Control

Table 153. Offset 48h: DCTL — Device Control

Size: 16 bit		Default: 0000h		Power Well: Core
Access		PCI Configuration		B:D:F 0:23-26:0
Offset Start: 48h		Offset End: 49h		
Bit Range	Default	Access	Acronym	Description
15	0b	RO	RSVD	Reserved
14 : 12	000b	RO	MRRS	Max Read Request Size: Hardwired to 0
11	0b	RO	ENS	Enable No Snoop: Not supported. The root port will never issue non-snoop requests.
10	0b	RW	APME	AUX Power PM Enable: This must be RW for OS testing. The OS will set this bit to '1' if the device connected has detected AUX power. It has no effect on the root port otherwise.
09	0b	RO	PFE	Phantom Functions Enable: Not supported
08	0b	RO	ETFE	Extended Tag Field Enable: Not supported
07 : 05	000b	RW	MPS	Max Payload Size: The root port only supports 128B payloads, regardless of the programming of this field.
04	0b	RO	ERO	Enable Relaxed Ordering: Not supported
03	0b	RW	URE	Unsupported Request Reporting Enable: When set, the root port will generate errors when detecting an unsupported request.
02	0b	RW	FEE	Fatal Error Reporting Enable: When set, the root port will generate errors when detecting a fatal error. When cleared, the root port will ignore fatal errors.
01	0b	RW	NFE	Non-Fatal Error Reporting Enable: When set, the root port will generate errors when detecting a non-fatal error. When cleared, the root port will ignore non-fatal errors.
00	0b	RW	CEE	Correctable Error Reporting Enable: When set, the root port will generate errors when detecting a correctable error. When cleared, the root port will ignore correctable errors.



8.2.2.5 DSTS — Device Status

Table 154. Offset 4Ah: DSTS — Device Status

Size: 16 bit		Default: 0010h		Power Well: Core
Access		PCI Configuration		B:D:F 0:23-26:0
Offset Start: 4Ah		Offset End: 4Bh		
Bit Range	Default	Access	Acronym	Description
15 : 06	0	RO	RSVD	Reserved
05	0	RO	TDP	Transactions Pending: This bit has no meaning for the root port since only one transaction may be pending to the processor. A read of this cannot occur until it has already returned to '0.'
04	1	RO	APD	AUX Power Detected: The root port contains AUX power for wake-up.
03	0	RWC	URD	Unsupported Request Detected: This indicates that an unsupported request was detected.
02	0	RWC	FED	Fatal Error Detected: This indicates that a fatal error was detected. It is set when a fatal error occurred on from a data link protocol error, buffer overflow, or malformed TLP.
01	0	RWC	NFED	Non-Fatal Error Detected: This indicates that a non-fatal error was detected. It is set when an received a non-fatal error occurred from a poisoned TLP, unexpected completions, unsupported requests, completer abort, or completer time-out.
00	0	RWC	CED	Correctable Error Detected: This indicates that a correctable error was detected. It is set when received an internal correctable error from receiver errors / framing errors, TLP CRC error, DLLP CRC error, replay num. rollover, or replay time-out.

8.2.2.6 LCAP — Link Capabilities

Table 155. Offset 4Ch: LCAP — Link Capabilities

Size: 32 bit		Default: XX154C11h		Power Well: Core
Access		PCI Configuration		B:D:F 0:23-26:0
Offset Start: 4Ch		Offset End: 4Fh		
Bit Range	Default	Access	Acronym	Description
31 : 24	01h, 02h, 03h or 04h	RO	PN	Port Number: This indicates the port number for the root port. This value is different for each implemented port. Port 0 reports 01h. Port 1 reports 02h. Port 2 reports 03h. Port 3 reports 04h.
23 : 21	0b	RO	RSVD	Reserved
20	1b	RO	LARC	Link Active Reporting Capable: This port supports the optional capability of reporting the DL_Active state of the Data Link Control and Management State Machine.
19	0b	RO	RSVD	Reserved
18	1b	RO	CPM	Clock Power Management: This indicates that clock power management is supported.
17 : 15	010b	RO	EL1	L1 Exit Latency: This indicates an exit latency of 2 μ s to 4 μ s.
14 : 12	100h	RO	ELO	L0s Exit Latency: This indicates an exit latency based on common-clock configuration. When cleared, it uses MPC.UCEL. When set, it uses MPC.CCEL.
11 : 10	3h	RO	APMS	Active State Link PM Support: This indicates that both L0s and L1 are supported.
09 : 04	01h	RO	MLW	Maximum Link Width: May only be a single lane
03 : 00	1h	RO	MLS	Maximum Link Speed: This indicates that the link speed is 2.5 Gb/s



8.2.2.7 LCTL — Link Control

Table 156. Offset 50h: LCTL — Link Control

Size: 16 bit		Default: 0000h		Power Well: Core
Access		PCI Configuration B:D:F 0:23-26:0		Offset Start: 50h Offset End: 51h
Bit Range	Default	Access	Acronym	Description
15 :	0	RO	RSVD	Reserved
07	0b	RW	ES	Extended Synch: When set, this forces extended transmission of FTS ordered sets in FTS and extra TS2 at exit from L1 prior to entering L0.
06	0b	RW	CCC	Common Clock Configuration: When set, this indicates that the processor and device are operating with a distributed common reference clock.
05	0b	RO/W	RL	Retrain Link: When set, the root port will train its downstream link. This bit always returns '0' when read. Software uses LSTS.LT and LSTS.LTE to check the status of training.
04	0b	RW	LD	Link Disable: When set, the root port will disable the link.
03	0b	RO	RCBC	Read Completion Boundary Control: Read completion boundary is 64 bytes.
02	0b	RO	RSVD	Reserved
01 : 00	0h	RW	APMC	Active State Link PM Control: This indicates if the root port should enter L0s or L1 or both. 00 = Disabled (The processor does not support disable mode; writing 00 has no effect.) 01 = L0s Entry Enabled 10 = L1 Entry Enabled 11 = L0s and L1 Entry Enabled

8.2.2.8 LSTS — Link Status

Table 157. Offset 52h: LSTS — Link Status

Size: 16 bit		Default: 1001h		Power Well: Core
Access		PCI Configuration B:D:F 0:23-26:0		Offset Start: 52h Offset End: 53h
Bit Range	Default	Access	Acronym	Description
13	0	RO	LA	Link Active: This is set to 1b when the Data Link Control and Management State Machine is in the DL_Active state; it is 0b otherwise.
12	1	RO	SCC	Slot Clock Configuration: The processor uses the same reference clock as on the platform and does not generate its own clock.
11	0	RO	LT	Link Training: The root port sets this bit whenever link training is occurring. It clears the bit on completion of link training.
10	0	RO	LTE	Link Training Error: Not supported
09 : 04	00h	RO	NLW	Negotiated Link Width: This may only take the value of a single link (01h). The value of this register is undefined if the link has not successfully trained.
03 : 00	1h	RO	LS	Link Speed: Link is 2.5 Gb/s.

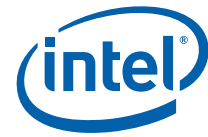

8.2.2.9 SLCAP — Slot Capabilities

Table 158. Offset 54h: SLCAP — Slot Capabilities

Size: 32 bit		Default: 00000060h		Power Well: Core
Access		PCI Configuration B:D:F 0:23-26:0		Offset Start: 54h Offset End: 57h
Bit Range	Default	Access	Acronym	Description
31 : 19	0000h	RWO	PSN	Physical Slot Number: This is a value that is unique to the slot number. The BIOS sets this field and it remains set until a platform reset.
18 : 17	00b	RO	RSVD	Reserved
16 : 15	00b	RWO	SLS	Slot Power Limit Scale: This specifies the scale used for the slot power limit value. The BIOS sets this field and it remains set until a platform reset.
14 : 07	00h	RWO	SLV	Slot Power Limit Value: This specifies the upper limit (in conjunction with SLS value), on the upper limit on power supplied by the slot. The two values together indicate the amount of power in watts allowed for the slot. The BIOS sets this field, and it remains set until a platform reset.
06	1b	RO	HPC	Hot Plug Capable: This indicates that hot plug is supported.
05	1b	RO	HPS	Hot Plug Surprise: This indicates that the device may be removed from the slot without prior notification.
04	0b	RO	PIP	Power Indicator Present: This indicates that a power indicator LED is not present for this slot.
03	0b	RO	AIP	Attention Indicator Present: This indicates that an attention indicator LED is not present for this slot.
02	0b	RO	MSP	MRL Sensor Present: This indicates that an MRL sensor is not present.
01	0b	RO	PCP	Power Controller Present: This indicates that a power controller is not implemented for this slot.
00	0b	RO	ABP	Attention Button Present: This indicates that an attention button is not implemented for this slot.

8.2.2.10 SLCTL — Slot Control

Table 159. Offset 58h: SLCTL — Slot Control (Sheet 1 of 2)

Size: 16 bit		Default: 0000h		Power Well: Core
Access		PCI Configuration B:D:F 0:23-26:0		Offset Start: 58h Offset End: 59h
Bit Range	Default	Access	Acronym	Description
15 : 13	0h	RO	RSVD	Reserved
12	0b	RW	LACE	Link Active Changed Enable: When set, this field enables generation of a hot plug interrupt when the Data Link Layer Link Active field is changed.
11 : 10	0b	RO	RSVD	Reserved
09 : 08	00b	RW	PIC	Power Indicator Control: PIC is not supported
07 : 06	00b	RW	AIC	Attention Indicator Control: AIC is not supported
05	0b	RW	HPE	Hot Plug Interrupt Enable: When set, enables generation of a hot plug interrupt on enabled hot plug events.
04	0b	RO	CCE	Command Completed Interrupt Enable: CCE is not supported



Table 159. Offset 58h: SLCTL — Slot Control (Sheet 2 of 2)

Size: 16 bit		Default: 0000h		Power Well: Core
Access		PCI Configuration		B:D:F 0:23-26:0
Offset Start: 58h		Offset End: 59h		
Bit Range	Default	Access	Acronym	Description
03	0b	RW	PDE	Presence Detect Changed Enable: When set, enables the generation of a hot plug interrupt or wake message when the presence detect logic changes state.
02	0b	RO	MSE	MRL Sensor Changed Enable: MSE is not supported, but it is read/write for ease of implementation and to easily draft off of the PCI Express* specification.
01	0b	RW	PFE	Power Fault Detected Enable: PFE is not supported, but it is read/write for ease of implementation and to easily draft off of the PCI Express* specification.
00	0b	RW	ABE	Attention Button Pressed Enable: ABE is not supported, but it is read/write for ease of implementation and to easily draft off of the PCI Express* specification.

8.2.2.11 SLSTS — Slot Status

Table 160. Offset 5Ah: SLSTS — Slot Status

Size: 16 bit		Default: 0000h		Power Well: Core
Access		PCI Configuration		B:D:F 0:23-26:0
Offset Start: 5Ah		Offset End: 5Bh		
Bit Range	Default	Access	Acronym	Description
15 : 09	0	RO	RSVD	Reserved
08	0	RWC	LASC	Link Active State Changed: This bit is set when the value reported in the Data Link Layer Link Active field of the Link Status register is changed. In response to a Data Link Layer State Changed event, software must read the Data Link Layer Link Active field of the Link Status register to determine if the link is active before initiating configuration cycles to the hot plugged device.
07	0	RO	RSVD	Reserved
06	0	RO	PDS	Presence Detect State: If XCAP.S1 is set (indicating that this root port spawns a slot), this bit indicates whether a device is connected ('1') or empty ('0'). If XCAP.S1 is cleared, this bit is a '1.'
05	0	RO	MS	MRL Sensor State: Reserved as the MRL sensor is not implemented
04	0	RO	RSVD	Reserved
03	0	RWC	PDC	Presence Detect Changed: This bit is set by the root port when the PDS bit changes state.
02	0	RO	MSC	MRL Sensor Changed: Reserved as the MRL sensor is not implemented
01	0	RO	PFD	Power Fault Detected: Reserved as a power controller is not implemented
00	0	RO	ABP	Attention Button Pressed: Reserved as Attention Button Pressed is not implemented



8.2.2.12 RCTL — Root Control

Table 161. Offset 5Ch: RCTL — Root Control

Size: 16 bit		Default: 0000h		Power Well: Core
Access		PCI Configuration B:D:F 0:23-26:0		Offset Start: 5Ch Offset End: 5Bh
Bit Range	Default	Access	Acronym	Description
15 : 04	0	RO	RSVD	Reserved
03	0	RW	PIE	PME Interrupt Enable: When set, this enables interrupt generation when RSTS.PS is in a set state (either due to a '0' to '1' transition, or due to this bit being set with RSTS.PS already set).
02	0	RW	SFE	SERR_B on FE Enable: When set, SERR_B is generated if a fatal error is reported on this port, including fatal errors in this port. This bit is not dependant on CMD.SEE being set.
01	0	RW	SNE	SERR_B on NFE Enable: When set, SERR_B is generated if a non-fatal error is reported on the port, including non-fatal errors in the port. This bit is not dependant on CMD.SEE being set.
00	0	RW	SCE	SERR_B on CE Enable: When set, SERR_B is generated if a correctable error is reported on this port, including correctable errors in this port. This bit is not dependant on CMD.SEE being set.

8.2.2.13 RCAP — Root Capabilities

Table 162. Offset 5Eh: RCAP — Root Capabilities

Size: 16 bit		Default: 0000h		Power Well: Core
Access		PCI Configuration B:D:F 0:23-26:0		Offset Start: 5Eh Offset End: 5Fh
Bit Range	Default	Access	Acronym	Description
15 : 01	0	RO	RSVD	Reserved
00	0	RO	CSV	CRS Software Visibility: This bit is not supported by the processor. This bit, when set, indicates that the Root Port is capable of returning Configuration Request Retry Status (CRS) Completion Status to software.

8.2.2.14 RSTS — Root Status

Table 163. Offset 60h: RSTS — Root Status

Size: 32 bit		Default: 00000000h		Power Well: Core
Access		PCI Configuration B:D:F 0:23-26:0		Offset Start: 60h Offset End: 63h
Bit Range	Default	Access	Acronym	Description
31 : 18	0	RO	RSVD	Reserved
17	0	RO	PP	PME Pending: This will never be set by the processor.
16	0	RWC	PS	PME Status: This indicates that PME was asserted by the requestor ID in RID. Subsequent PMEs are kept pending until this bit is cleared.
15 : 00	0	RO	RID	PME Requestor ID: This indicates the PCI requestor ID of the last PME requestor. Valid only when PS is set. Root ports are capable of storing the requestor ID for two PM_PME messages, with one active (this register) and a one deep pending queue. Subsequent PM_PME messages will be dropped.

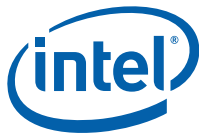

8.2.3 PCI Bridge Vendor Capability

Table 164. PCI Bridge Vendor Capability

Start	End	Symbol	Register Name
90	91	SVCAP	Subsystem Vendor Capability ID
94	97	SVID	Subsystem Vendor IDs

8.2.3.1 SVCAP — Subsystem Vendor Capability

Table 165. Offset 90h: SVCAP — Subsystem Vendor Capability

Size: 16 bit		Default: 0000h		Power Well: Core
Access		PCI Configuration B:D:F 0:23-26:0		Offset Start: 90h Offset End: 91h
Bit Range	Default	Access	Acronym	Description
15 : 08	A0h	RO	NEXT	Next Capability: This indicates the location of the next pointer in the list.
07 : 00	0Dh	RO	CID	Capability Identifier: The value of 0Dh indicates that this is a PCI bridge subsystem vendor capability.

8.2.3.2 SVID — Subsystem Vendor IDs

Table 166. Offset 94h: SVID — Subsystem Vendor IDs

Size: 32 bit		Default: 0000h		Power Well: Core
Access		PCI Configuration B:D:F 0:23-26:0		Offset Start: 94h Offset End: 97h
Bit Range	Default	Access	Acronym	Description
31 : 00	00000000h	RO	SVID	Subsystem Vendor ID: The value in this register matches the value of the SS register in the LPC bridge.

8.2.4 PCI Power Management Capability

Table 167. PCI Power Management Capability

Start	End	Symbol	Register Name
A0	A1	PMCAP	Power Management Capability ID
A2	A3	PMC	Power Management Capabilities
A4	A7	PMCS	Power Management Control And Status



8.2.4.1 PMCAP — Power Management Capability ID

Table 168. Offset A0h: PMCAP — Power Management Capability ID

Size: 16 bit		Default: 0001h		Power Well: Core
Access		PCI Configuration B:D:F 0:23-26:0		Offset Start: A0h Offset End: A1h
Bit Range	Default	Access	Acronym	Description
15 : 08	00h	RO	NEXT	Next Capability: Last item in the list
07 : 00	01h	RO	CID	Capability Identifier: The value of 01h indicates that this is a PCI power management capability.

8.2.4.2 PMC — PCI Power Management Capabilities

Table 169. Offset A2h: PMC — PCI Power Management Capabilities

Size: 16 bit		Default: C802h		Power Well: Core
Access		PCI Configuration B:D:F 0:23-26:0		Offset Start: A2h Offset End: A3h
Bit Range	Default	Access	Acronym	Description
15 : 11	11001	RO	PMES	PME Support: This indicates that PME_B is supported for states D0, D3 _{HOT} and D3 _{COLD} . The root port does not generate PME_B, but reporting that it does is necessary for legacy Microsoft* operating systems to enable PME_B in devices connected behind this root port.
10	0	RO	D2S	D2 Support: The D2 state is not supported.
09	0	RO	D1S	D1 Support: The D1 state is not supported.
08 : 06	000	RO	AC	AUX Current: This reports the 375 mA maximum suspend well current when in the D3 _{COLD} state.
05	0	RO	DSI	Device Specific Initialization: This indicates that no device-specific initialization is required.
04	0	RO	RSVD	Reserved
03	0	RO	PMEC	PME Clock: This indicates that the PCI clock is not required to generate PME_B.
02 : 00	010	RO	VS	Version: This indicates support for Revision 1.1 of the <i>PCI Power Management Specification</i> .

8.2.4.3 PMCS — PCI Power Management Control And Status

Table 170. Offset A4h: PMCS — PCI Power Management Control And Status (Sheet 1 of 2)

Size: 32 bit		Default: 00000000h		Power Well: Core
Access		PCI Configuration B:D:F 0:23-26:0		Offset Start: A4h Offset End: A7h
Bit Range	Default	Access	Acronym	Description
31 : 16	0	RO	RSVD	Reserved
15	0	RO	PMES	PME Status: This indicates that a PME was received on the downstream link.
14 : 09	0	RO	RSVD	Reserved



Table 170. Offset A4h: PMCS — PCI Power Management Control And Status (Sheet 2 of 2)

Size: 32 bit		Default: 00000000h		Power Well: Core
Access		PCI Configuration		Offset Start: A4h Offset End: A7h
		B:D:F 0:23-26:0		
Bit Range	Default	Access	Acronym	Description
08	0	RW	PMEE	PME Enable: The root port takes no action on this bit, but it must be RW for legacy Microsoft* operating systems to enable PME on devices connected to this root port.
07 : 02	0	RO	RSVD	Reserved
01 : 00	00	RW	PS	Power State: This field is used both to determine the current power state of the root port and to set a new power state. The values are: 00 = D0 state 11 = D3 _{HOT} state When in D3 _{HOT} , the port's configuration space is available, but I/O, memory, and type 1 configuration cycles are not accepted. Interrupts are blocked as software disables interrupts prior to placing the port into D3 _{HOT} . Writes of '10' or '01' are ignored.

8.2.5 Port Configuration

Table 171. Port Configuration

Start	End	Symbol	Register Name
D8	DB	MPC	Miscellaneous Port Configuration
DC	DF	SMSCS	SMI / SCI Status



8.2.5.1 MPC — Miscellaneous Port Configuration

Table 172. Offset D8h: MPC — Miscellaneous Port Configuration

Size: 32 bit		Default: 00110000h		Power Well: Core
Access		PCI Configuration		B:D:F 0:23-26:0
				Offset Start: D8h Offset End: DBh
Bit Range	Default	Access	Acronym	Description
31	0	RW	PMCE	Power Management SCI Enable: This enables SCI for power management events.
30	0	RW	HPCE	Hot Plug SCI Enable: This enables SCI for hot plug events.
29	0	RW	LHO	Link Hold Off: When set, the port will not take any TLP. It is used during loopback mode to fill the downstream queue.
28	0	RW	ATE	Address Translator Enable: This enables address translation via AT during loopback mode.
27 : 21	0000000	RO	RSVD	Reserved
20 : 18	100	RW	UCEL	Unique Clock Exit Latency: L0s Exit Latency when LCAP.CCC is cleared.
17 : 15	010	RW	CCEL	Common Clock Exit Latency: L0s Exit Latency when LCAP.CCC is set.
14 : 12	000	RW	RSVD	Reserved
11 : 08	0	RW	AT	Address Translator: During loopback, these bits are XORd with bits [31:28] of the receive address when ATE is set.
07 : 02	000000	RO	RSVD	Reserved
01	0	RW	HPME	Hot Plug SMI Enable: This enables the port to generate SMI for hot plug events.
00	0	RW	PMME	Power Management SMI Enable: This enables the port to generate SMI for power management events.

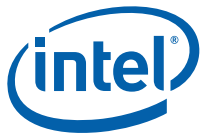

8.2.5.2 SMSCS — SMI / SCI Status

Table 173. Offset DCh: SMSCS — SMI / SCI Status

Size: 32 bit		Default: 00000000h		Power Well: Core
Access		PCI Configuration		Offset Start: DCh Offset End: DFh
		B:D:F 0:23-26:0		
Bit Range	Default	Access	Acronym	Description
31	0	RWC	PMCS	Power Management SCI Status: This is set if the root port PME control logic needs to generate an interrupt and this interrupt has been routed to generate an SCI.
30	0	RWC	HPCS	Hot Plug SCI Status: This is set if the hot plug controller needs to generate an interrupt and this interrupt has been routed to generate an SCI.
29 : 05	0	RO	RSVD	Reserved
04	0	RWC	HPLAS	Hot Plug Link Active State Changed SMI Status: This is set when SLSTS.LASC transitions from '0' to '1' and MPC.HPME is set. When set, SMI_B is generated.
03 : 02	0	RO	RSVD	Reserved
01	0	RWC	HPPDM	Hot Plug Presence Detect SMI Status: This is set when SLSTS.PDC transitions from '0' to '1' and MPC.HPME is set. When set, SMI_B is generated.
00	0	RWC	PMMS	Power Management SMI Status: This is set when RSTS.PS transitions from '0' to '1' and MPC.PMME is set. When set, SMI_B is generated.



8.2.6 Miscellaneous Configuration

Table 174. Miscellaneous Configuration

Start	End	Symbol	Register Name
FC	FF	FD	Functional Disable

8.2.6.1 FD — Functional Disable

Table 175. Offset FCh: FD — Functional Disable

Size: 32 bit		Default: 00000000h		Power Well: Core
Access		PCI Configuration B:D:F 0:23-26:0		Offset Start: FCh Offset End: FFh
Bit Range	Default	Access	Acronym	Description
31 :03	0	RO	RSVD	Reserved
02	0	RW	CGD	Reserved
01	0	RO	RSVD	Reserved
00	0	RW	D	Disable: When set, the function is disabled (configuration space is disabled).

§ §



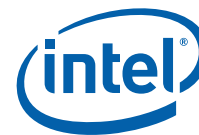

9.0 Intel® High Definition Audio^β D27:F0

9.1 Overview

The Intel® High Definition Audio^β controller consists of a set of DMA engines that are used to move samples of digitally encoded data between system memory and an external codec(s). The controller communicates with the external codec(s) over the Intel® HD Audio^β serial link. The Intel® Atom™ Processor E6xx Series implements two output DMA engines and two input DMA engines. The Output DMA engines move digital data from system memory to a D-A converter in a codec. The processor implements a single Serial Data Output signal (HDA_SDO) that is connected to all external codecs. The Input DMA engines move digital data from the A-D converter in the codec to system memory. The processor supports up to two external codecs by implementing two Serial Data Input signals (HDA_SDI[1:0]), one dedicated to each of the supported codecs.

Audio software renders outbound, and processes inbound data to/from buffers in system memory. The location of the individual buffers is described by a Buffer Descriptor List (BDL) that is fetched and processed by the controller. The data in the buffers is arranged in a pre-defined format. The output DMA engines fetch the digital data from memory and reformat it based on the programmed sample rate, bits/sample and number of channels. The data from the output DMA engines is then combined and serially sent to the external codec(s) over the Intel® HD Audio^β link. The Input DMA engines receive data from the codec(s) over the Intel® HD Audio^β link and format the data based on the programmable attributes for that stream. The data is then written to memory in the pre-defined format for software to process. Each DMA engine moves one "stream" of data. A single codec can accept or generate multiple "streams" of data, one for each A-D or D-A converter in the codec. Multiple codecs can accept the same output "stream" processed by a single DMA engine.

Codec commands and responses are also transported to and from the codec via DMA engines. The DMA engine dedicated to transporting commands from the Command Output Ring Buffer (CORB) in memory to the codec(s) is called the CORB engine. The DMA engine dedicated to transporting responses from the codec(s) to the Response Input Ring Buffer in memory is called the RIRB engine. Every command sent to a codec yields a response from that codec. Some commands are "broadcast" type commands in which case a response will be generated from each codec. A codec may also be programmed to generate unsolicited responses, which the RIRB engine also processes. The processor also supports Programmed IO-based Immediate Command/Response transport mechanism that can be used by BIOS for memory initialization.

9.2 Docking

The Intel® Atom™ Processor E6xx Series controls an external switch that is used to either electrically connect or isolate a dock codec in the docking station from the processor and the Intel® HD Audio^β codec(s) on the motherboard. Prior to and during the physical docking process the dock codec will be electrically isolated from the processor's Intel® HD Audio^β interface. When the physical docking occurs, software will be notified via ACPI control methods. Software then initiates the docking sequence in the Intel® HD Audio^β controller. The Intel® HD Audio^β controller manages the external switch such that the electrical connection between the dock codec and the processor's Intel® HD Audio^β interface occurs during the proper time within the frame sequence and when the signals are not transitioning.

The processor also drives a dedicated reset signal to the dock codec(s). It sequences the switch control signal and dedicated reset signal correctly such that the dock codec experiences a "normal" reset as specified in the Intel® HD Audio^β specification.

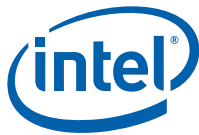

Prior to the physical undocking process the user normally requests undocking. Software then gracefully halts the streams to the codecs in the docking station and then initiates the undocking sequence in the Intel® HD Audio^β controller. Intel® HD Audio^β controller asserts dock reset and then manages the external switch to electrically isolate the dock codec from the processor's Intel® HD Audio^β interface prior to physical undocking. Electrical isolation during surprise undocking is handled external to the Intel® HD Audio^β controller, and software invokes the undocking sequence in the Intel® HD Audio^β controller as part of the clean-up process simply to prepare for a subsequent docking event. The Intel® HD Audio^β controller isn't aware that a surprise undock occurred.

9.2.1 Dock Sequence

Note:

This sequence is followed when the system is running and a docking event occurs as well as when resuming from S3 (RESET_B asserted) and Intel® HD Audio^β controller D3.

1. Since the Intel® Atom™ Processor E6xx Series supports docking, the Docking Supported (DCKSTS.DS) bit defaults to a 1. Post BIOS and ACPI Software use this bit to determine if the Intel® HD Audio^β controller supports docking. BIOS may write a 0 to this RWO bit during POST to effectively turn off the docking feature.
2. After reset in the undocked quiescent state, the Dock Attach (DCKCTL.DA) bit and the Dock Mate (DCKSTS.DM) bit are both de-asserted. The HDA_DOCK_EN_B signal is de-asserted and HDA_DOCKRST_B is asserted. HDA_CLK, HDA_SYNC and HDA_SDO signals may or may not be running at the point in time that the docking event occurs.
3. The physical docking event is signaled to ACPI BIOS software via ACPI control methods. How this is done is outside the scope of this specification.
4. ACPI BIOS software first checks that the docking is supported via DCKSTS.DS=1 and that the DCKSTS.DM=0 and then initiates the docking sequence by writing a 1 to the DCKCTL.DA bit.
5. The Intel® HD Audio^β controller then asserts the HDA_DOCK_EN_B signal so that the HDA_CLK signal begins toggling to the dock codec. HDA_DOCK_EN_B shall be asserted synchronously to HDA_CLK and timed such that HDA_CLK is low, HDA_SYNC is low, and HDA_SDO is low. The first 8 bits of the Command field are "reserved" and always driven to 0. This creates a predictable point in time to always assert HDA_DOCK_EN_B.
6. After the controller asserts HDA_DOCK_EN_B it waits for a minimum of 2400 HDA_CLKs (100 μs) and then de-asserts HDA_DOCKRST_B. This is done in such a way to meet the Intel® HD Audio^β link reset exit specification. HDA_DOCKRST_B de-assertion should be synchronous to HDA_CLK and timed such that there are least four full HDA_CLKs from the de-assertion of HDA_DOCKRST_B to the first frame HDA_SYNC assertion.
7. The Connect/Turnaround/Address Frame hardware initialization sequence will now occur on the dock codecs' HDA_SDI signals. A dock codec is detected when HDA_SDI is high on the last HDA_CLK cycle of the Frame Sync of a Connect Frame. The appropriate bit(s) in the State Change Status (STATESTS) register will be set. The Turnaround and Address Frame initialization sequence then occurs on the dock codecs' HDA_SDI(s).
8. After this hardware initialization sequence is complete (approximately 32 frames), the controller hardware sets the DCKSTS.DM bit to 1 indicating that the dock is now mated. ACPI BIOS polls the DCKSTS.DM bit and when it detects it is set to 1, conveys this to the OS through a plug-N-play IRP. This eventually invokes the Intel® HD Audio^β Bus Driver which then begins its codec discovery, enumeration, and configuration process. Intel® HD Audio^β Bus Driver software "discovers" the dock codecs by comparing the bits now set in the STATESTS register with the bits that were set prior to the docking event.



9.2.2 Undock Sequence

There are two possible undocking scenarios. The first is the one that is initiated by the user that invokes software and gracefully shuts down the dock codecs before they are undocked. The second is referred to as the “surprise undock” where the user undocks while the dock codec is running. Both of these situations appear the same to the controller as it is not cognizant of the “surprise removal”.

1. In the docked quiescent state, the Dock Attach (DCKCTL.DA) bit and the Dock Mate (DCKSTS.DM) bit are both asserted. The HDA_DOCK_EN_B signal is asserted and HDA_DOCKRST_B is de-asserted.
2. The user initiates an undock event through the GUI interface or by pushing a button. This mechanism is outside the scope of this section of the document. Either way ACPI BIOS software will be invoked to manage the undock process.
3. ACPI BIOS will call the The Intel® HD Audio^β Bus Driver driver software in order to halt the stream to the dock codec(s) prior to electrical undocking. If the Intel® HD Audio^β Bus Driver is not capable of halting the stream to the docked codec, ACPI BIOS will initiate the hardware undocking sequence as described in the next step while the dock stream is still running. From this standpoint, the result is similar to the “surprise undock” scenario where an audio glitch may occur to the docked codec(s) during the undock process.
4. The ACPI BIOS initiates the hardware undocking sequence by writing a 0 to the DCKCTL.DA bit.
5. The Intel® HD Audio^β controller asserts HDA_DOCKRST_B. HDA_DOCKRST_B assertion shall be synchronous to HDA_CLK. HDA_DOCKRST_B assertion will occur a minimum of 4 HDA_CLKs after the completion of the current frame. Note that the Intel® HD Audio^β link reset specification requirement that the last Frame sync be skipped will not be met.
6. A minimum of four HDA_CLKs after HDA_DOCKRST_B the controller will de-assert HDA_DOCK_EN_B to isolate the dock codec signals from the Intel® HD Audio^β link signals. HDA_DOCK_EN_B is de-asserted synchronously to HDA_CLK and timed such that HDA_CLK, HDA_SYNC, and HDA_SDO are low.
7. After this hardware undocking sequence is complete, the controller hardware clears the DCKSTS.DM bit to 0 indicating that the dock is now un-mated. ACPI BIOS software polls DCKSTS.DM and when it sees DM set, conveys to the end user that physical undocking can proceed. The controller is now ready for a subsequent docking event.

9.2.3 Relationship Between HDA_DOCKRST_B and HDA_RST_B

HDA_RST_B will be asserted when a RESET_B occurs or when the CRST_B bit is 0. As long as HDA_RST_B is asserted, the HDA_DOCKRST_B signal will also be asserted.

When RESET_B is asserted, the DCKCTL.DA and DCKSTS.DM bits will be get cleared to their default state (0's), and the dock state machine will be reset such that HDA_DOCK_EN_B will be de-asserted, and HDA_DOCKRST_B will be asserted. After any RESET_B, POST BIOS software is responsible for detecting that a dock is attached and then writing a “1” to the DCKCTL.DA bit prior to the Intel® HD Audio^β Bus Driver de-asserting CRST_B.

When CRST_B bit is “0” (asserted), the DCKCTL.DA bit is not cleared. The dock state machine will be reset such that HDA_DOCK_EN_B will be de-asserted, HDA_DOCKRST_B will be asserted and the DCKSTS.DM bit will be cleared to reflect this state. When the CRST_B bit is de-asserted, the dock state machine will detect that DCKCTL.DA is set to “1” and will begin sequencing through the dock process. Note that this does not require any software intervention.

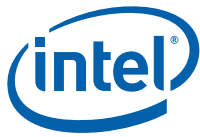

9.2.4 External Pull-Ups/Pull-Downs

The following table shows the resistors that should be mounted on the dock side of the isolation switch. The resistors are used to discharge the signals to reduce the chance of getting charge-sharing induced glitches when the switch is turned on via HDA_DOCK_EN_B assertion. Pull-downs have been specified to match the level of the signals when HDA_DOCK_EN_B is asserted as well as to not conflict with the internal resistors.

Table 176. External Resistors

Signal	Internal Resistors ¹	External Resistors on Dock Side of Isolation Switch ¹
HDA_CLK	Weak Pull-down	None
HDA_SYNC	None	Weak Pull-Down
HDA_SDO	None	Weak Pull-Down
HDA_SDI (from docked codec(s))	Weak Pull-down	None
HDA_RST_B	None	NA
HDA_DOCK_EN_B	None	NA
HDA_DOCKRST_B	None	Weak Pull-Down

Note:

1. Weak Pull-down is about 10 kΩ.

9.3 PCI Configuration Register Space

The Intel® HD Audio^β controller resides in PCI Device 27, Function 0 on Bus 0. This function contains a set of DMA engines that are used to move samples of digitally encoded data between system memory and external codecs.

All controller registers (including the memory mapped registers) must be addressable as byte, word, and D-word quantities. The software must always make register accesses on natural boundaries (i.e., D-word accesses must be on D-word boundaries, word accesses on word boundaries, etc.). Note that the Intel® HD Audio^β memory-mapped register space must not be accessed with the LOCK semantic exclusive-access mechanism. If software attempts exclusive-access mechanisms to the Intel® HD Audio^β memory-mapped register space, the results are undefined.

9.3.1 Registers

Table 177. Intel® High Definition Audio^β PCI Configuration Registers (Sheet 1 of 3)

Start	End	Symbol	Register Name	Reset Value	Access
00	01	VID	Vendor Identification	8086h	RO
02	03	DID	Device Identification	811Bh	RO
04	05	PCICMD	PCI Command	0000h	RW, RO
06	07	PCISTS	PCI Device Status	0010h	RO
08	08	RID	Revision Identification	01h (for B-0 Stepping) 02h (for B-1 Stepping)	RO
09	0B	CC	Class Codes	040300h	RO

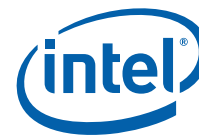
Table 177. Intel® High Definition Audio^β PCI Configuration Registers (Sheet 2 of 3)

Start	End	Symbol	Register Name	Reset Value	Access
0C	0C	CLS	Cache Line Size	00h	RW
0D	0D	LT	Latency Timer	00h	RO
0E	0E	HEADTYP	Header Type	00h	RO
10	13	LBAR	Intel® HD Audio ^β Lower Base Address (Memory)	00000004h	RW, RO
14	17	UBAR	Intel® HD Audio ^β Upper Base Address (Memory)	00000000h	RW
2C	2D	SVID	Subsystem Vendor Identifier	0000h	RWO
2E	2F	SID	Subsystem Identifier	0000h	RWO
34	34	CAP_PTR	Capabilities Pointer	50h	RO
3C	3C	INTLN	Interrupt Line	00h	RW
3D	3D	INTPN	Interrupt Pin	Variable	RO
40	40	HDCTL	Intel® HD Audio ^β Control	00h	RW, RO
4C	4C	DCKCTL	Docking Control	00h	RW, RO
4D	4D	DCKSTS	Docking Status	80h	RWO, RO
50	51	PM_CAPID	PCI Power Management Capability ID	01h	RO
52	53	PM_CAP	Power Management Capabilities	C842h	RO
54	57	PM_CTL_STS	Power Management Control and Status	0000h	RW, RO, RWC
60	61	MSI_CAPID	MSI Capability ID	0005h	RO
62	63	MSI_CTL	MSI Message Control	0080h	RW, RO
64	67	MSI_ADR	MSI Message Address	0000_0000h	RW, RO
68	69	MSI_DATA	MSI Message Data	0000h	RW
70	71	PCIE_CAPID	PCI Express* Capability Identifiers	10h	RO
72	73	PCIECAP	PCI Express* Capabilities	0091h	RO
74	77	DEVCAP	Device Capabilities	0000_0000h	RO
78	79	DEVC	Device Control	0800h	RW, RO
7A	7B	DEVS	Device Status	0000h	RO
FC	FF	FD	Function Disable	0000_0000h	RW, RO
100	103	VCCAP	Virtual Channel Enhanced Capability Header	1301_0002h	RO
104	107	PVCCAP1	Port VC Capability Register 1	0000_0001h	RO
108	10B	PVCCAP2	Port VC Capability Register 2	0000_0000h	RO
10C	10D	PVCCTL	Port VC Control	0000h	RO
10E	10F	PVCSTS	Port VC Status	0000h	RO
110	113	VC0CAP	VC0 Resource Capability	0000_0000h	RO
114	117	VC0CTL	VC0 Resource Control	8000_00FFh	RW, RO
11A	11B	VC0STS	VC0 Resource Status	0000h	RO
11C	11F	VC1CAP	VC1 Resource Capability	0000_0000h	RO
120	123	VC1CTL	VC1 Resource Control	0000_0000h	RW, RO
126	127	VC1STS	VC1 Resource Status	0000h	RO
130	133	RCCAP	Root Complex Link Declaration Enhanced Capability Header	0001_0005h	RO

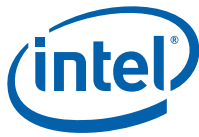

Table 177. Intel® High Definition Audio^β PCI Configuration Registers (Sheet 3 of 3)

Start	End	Symbol	Register Name	Reset Value	Access
134	137	ESD	Element Self Description	0F00_0100h	RO
140	143	L1DESC	Link 1 Description	0000_0001	RO
148	14B	L1ADD	Link 1 Address Register	Variable	RW, RO

9.3.1.1 Offset 00h: VID – Vendor Identification

Table 178. 00h: VID – Vendor Identification

Size: 16 bit		Default: 8086h		Power Well: Core
Access		PCI Configuration B:D:F 0:27:0		Offset Start: 00h Offset End: 01h
Bit Range	Default	Access	Acronym	Description
15 :00	8086h	RO	VID	Vendor ID: This is a 16-bit value assigned to Intel. Intel VID=8086h

9.3.1.2 Offset 02h: DID – Device Identification

Table 179. 02h: DID – Device Identification

Size: 16 bit		Default: 811Bh		Power Well: Core
Access		PCI Configuration B:D:F 0:27:0		Offset Start: 02h Offset End: 03h
Bit Range	Default	Access	Acronym	Description
15 :00	811Bh	RO	DID	Device ID: This is a 16-bit value assigned to the Intel® HD Audio ^β controller.

9.3.1.3 Offset 04h: PCICMD – PCI Command Register

Table 180. 04h: PCICMD – PCI Command Register (Sheet 1 of 2)

Size: 16 bit		Default: 0000h		Power Well: Core
Access		PCI Configuration B:D:F 0:27:0		Offset Start: 04h Offset End: 05h
Bit Range	Default	Access	Acronym	Description
15 :11	0	RO	RSVD	Reserved
10	0	RW	ID	Interrupt Disable: Enables the device to assert an INTx_B. When set, the Intel® HD Audio ^β controller's INTx_B signal will be de-asserted. When cleared, the INTx_B signal may be asserted. Note that this bit does not affect the generation of MSI's.
09 :03	0	RO	RSVD	Reserved
02	0	RW	BME	Bus Master Enable: Controls standard PCI Express* bus mastering capability for Memory and I/O, reads and writes. Note that this bit also controls MSI generation since MSI's are essentially Memory writes. 0= Disable 1= Enable



Table 180. 04h: PCICMD – PCI Command Register (Sheet 2 of 2)

Size: 16 bit		Default: 0000h		Power Well: Core
Access		PCI Configuration B:D:F 0:27:0		Offset Start: 04h Offset End: 05h
Bit Range	Default	Access	Acronym	Description
01	0	RW	MSE	Memory Space Enable: When set, enables memory space accesses to the Intel® HD Audio ^β controller. 0= Disable 1= Enable
00	0	RO	RSVD	Reserved

9.3.1.4 Offset 06h: PCISTS – PCI Status Register

Table 181. 06h: PCISTS – PCI Status Register

Size: 16 bit		Default: 0010h		Power Well: Core
Access		PCI Configuration B:D:F 0:27:0		Offset Start: 06h Offset End: 07h
Bit Range	Default	Access	Acronym	Description
15 :05	0	RO	RSVD	Reserved
04	1	RO	CAP_LIST	Capabilities List Exists: Hardwired to 1. Indicates that the controller contains a capabilities pointer list. The first item is pointed to by looking at configuration offset 34h.
03	0	RO	IS	Interrupt Status: 0= This bit is 0 after the interrupt is cleared. 1= This bit is 1 when the INTx_B is asserted.
02 :00	0	RO	RSVD	Reserved

9.3.1.5 Offset 08h: RID – Revision Identification Register

Table 182. 08h: RID – Revision Identification Register

Size: 8 bit		Default: Refer to bit description		Power Well: Core
Access		PCI Configuration B:D:F 0:27:0		Offset Start: 08h Offset End: 08h
Bit Range	Default	Access	Acronym	Description
07 :00	Refer to bit description	RO	RID	Revision ID: Indicates the device specific revision identifier. For the B-0 Stepping, this value is 01h. For the B-1 Stepping, this value is 02h.



9.3.1.6 Offset 09h: CC – Class Codes Register

Table 183. 09h: CC – Class Codes Register

Size: 24 bit		Default: 040300h		Power Well: Core
Access		PCI Configuration		B:D:F 0: 27:0
Offset Start: 09h Offset End: 0Bh				
Bit Range	Default	Access	Acronym	Description
23 : 16	04h	RO	BCC	Base Class Code: This register indicates that the function implements a multimedia device.
15 : 08	03h	RO	SCC	Sub Class Code: This indicates the device is an Intel® HD Audio ^β audio device, in the context of a multimedia device.
07 : 00	00h	RO	PI	Programming Interface: Indicates Intel® HD Audio ^β programming interface.

9.3.1.7 Offset 0Ch: CLS - Cache Line Size Register

Table 184. 0Ch: CLS - Cache Line Size Register

Size: 8 bit		Default: 00h		Power Well: Core
Access		PCI Configuration		B:D:F 0: 27:0
Offset Start: 0Ch Offset End: 0Ch				
Bit Range	Default	Access	Acronym	Description
07 : 00	00h	RW	CLS	Cache Line Size: Doesn't apply to PCI Express*. The PCI Express* specification requires this to be implemented as a RW register but has no functional impact on the Intel® HD Audio ^β controller.

9.3.1.8 Offset 0Dh: LT – Latency Timer Register

Table 185. 0Dh: LT – Latency Timer Register

Size: 8 bit		Default: 00h		Power Well: Core
Access		PCI Configuration		B:D:F 0: 27:0
Offset Start: 0Dh Offset End: 0Dh				
Bit Range	Default	Access	Acronym	Description
07 : 00	00h	RO	LT	Latency Timer: Doesn't apply to PCI Express*. Hardwired to 00h.



9.3.1.9 Offset 0Eh: HEADTYP - Header Type Register

Table 186. 0Eh: HEADTYP - Header Type Register

Size: 8 bit		Default: 00h		Power Well: Core
Access		PCI Configuration		Offset Start: 0Eh Offset End: 0Eh
		B:D:F 0:27:0		
Bit Range	Default	Access	Acronym	Description
07 :00	00h	RO	HEADTYP	Header Type: Implements Type 0 Configuration header.

9.3.1.10 Offset 10h: LBAR – Lower Base Address Register

This BAR creates 16 Kbytes of memory space to signify the base address of Intel® HD Audio^β memory mapped configuration registers.

Table 187. 10h: LBAR – Lower Base Address Register

Size: 32 bit		Default: 00000004h		Power Well: Core
Access		PCI Configuration		Offset Start: 10h Offset End: 13h
		B:D:F 0:27:0		
Bit Range	Default	Access	Acronym	Description
31 :14	0	RW	LBA	Lower Base Address: Base address for the Intel® HD Audio ^β controller's memory mapped configuration registers. 16 Kbytes are requested by hardwiring bits 13:4 to 0's.
13 :04	0	RO		Hardwired to 0.
03	0	RO	PREF	Prefetchable: Indicates that this BAR is NOT pre-fetchable.
02 :01	10	RO	ADDRNG	Address Range: Indicates that this BAR can be located anywhere in 32-bit address space.
00	0	RO	RTE	Resource Type: Indicates that this BAR is located in memory space.

9.3.1.11 Offset 14h: UBAR – Upper Base Address Register

Table 188. 14h: UBAR – Upper Base Address Register

Size: 32 bit		Default: 00000000h		Power Well: Core
Access		PCI Configuration		Offset Start: 14h Offset End: 17h
		B:D:F 0:27:0		
Bit Range	Default	Access	Acronym	Description
31 :00	0	RW	UBA	Upper Base Address: Upper 32 bits of the Base address for the Intel® HD Audio ^β controller's memory mapped configuration registers.

9.3.1.12 Offset 2Ch: SVID—Subsystem Vendor Identifier

This register should be implemented for any function that could be instantiated more than once in a given system, for example, a system with 2 audio subsystems, one down on the motherboard and the other plugged into a PCI expansion slot, should have the SVID register implemented. The SVID register, in combination with the Subsystem ID register, enables the operating environment to distinguish one audio subsystem from the other.



Software (BIOS) will write the value to this register. After that, the value can be read, but writes to the register will have no effect. The write to this register should be combined with the write to the SID to create one 32-bit write. This register is not affected by D3_{HOT} to D0 reset.

Table 189. 2Ch: SVID—Subsystem Vendor Identifier

Size: 16 bit		Default: 0000h		Power Well: Core
Access		PCI Configuration B:D:F 0:27:0		Offset Start: 2Ch Offset End: 2Dh
Bit Range	Default	Access	Acronym	Description
15 :00	0000h	RWO	SVID	Subsystem Vendor ID: These RWO bits have no functionality.

9.3.1.13 Offset 2Eh: SID—Subsystem Identifier

This register should be implemented for any function that could be instantiated more than once in a given system, for example, a system with 2 audio subsystems, one down on the motherboard and the other plugged into a PCI expansion slot. The SID register, in combination with the Subsystem Vendor ID register make it possible for the operating environment to distinguish one audio subsystem from the other.

Software (BIOS) will write the value to this register. After that, the value can be read, but writes to the register will have no effect. The write to this register should be combined with the write to the SVID to create one 32-bit write. This register is not affected by D3_{HOT} to D0 reset.

Table 190. 2Eh: SID—Subsystem Identifier

Size: 16 bit		Default: 0000h		Power Well: Core
Access		PCI Configuration B:D:F 0:27:0		Offset Start: 2Eh Offset End: 2Fh
Bit Range	Default	Access	Acronym	Description
15 :00	0000h	RWO	SID	Subsystem ID: These RWO bits have no functionality.

9.3.1.14 Offset 34h – CAP_PTR – Capabilities Pointer Register

Table 191. 34h – CAP_PTR – Capabilities Pointer Register

Size: 8 bit		Default: 50h		Power Well: Core
Access		PCI Configuration B:D:F 0:27:0		Offset Start: 34h Offset End: 34h
Bit Range	Default	Access	Acronym	Description
07 :00	50h	RO	SID	Capability Pointer: Indicates that the first capability pointer offset is offset 50h (Power Management Capability).



9.3.1.15 Offset 3Ch – INTLN: Interrupt Line Register

Table 192. 3Ch – INTLN: Interrupt Line Register

Size: 8 bit		Default: 00h		Power Well: Core
Access		PCI Configuration B:D:F 0:27:0		Offset Start: 3Ch Offset End: 3Ch
Bit Range	Default	Access	Acronym	Description
07 : 00	00h	RW		Interrupt Line: The processor does not use this field directly. It is used to communicate to software the interrupt line that the interrupt pin is connected to.

9.3.1.16 Offset 3Dh – INTPN—Interrupt Pin Register

Table 193. 3Dh – INTPN – Interrupt Pin Register

Size: 8 bit		Default: Variable		Power Well: Core
Access		PCI Configuration B:D:F 0:27:0		Offset Start: 3Dh Offset End: 3Dh
Bit Range	Default	Access	Acronym	Description
07 : 04	0	RO	RSVD	Reserved
03 : 00	0	RO		Interrupt Pin: This reflects the value of D27IP.ZIP (Chipset Config Registers: Offset 3110h: bits 3:0).

9.3.1.17 Offset 40h – HDCTL— Intel® High Definition Audio^β Control Register

Table 194. 40h – HDCTL— Intel® High Definition Audio^β Control Register

Size: 8 bit		Default: 00h		Power Well: Core
Access		PCI Configuration B:D:F 0:27:0		Offset Start: 40h Offset End: 40h
Bit Range	Default	Access	Acronym	Description
07 : 01	0	RO	RSVD	Reserved
00	0	RO	LMVE	Low Voltage Mode Enable: LVM is not supported. 0 = The Intel® HD Audio ^β controller operates in high voltage mode. 1 = The Intel® HD Audio ^β controller's AFE operates in low voltage mode.



9.3.1.18 Offset 4Ch – DCKCTL—Docking Control Register

Table 195. 4Ch – DCKCTL – Docking Control Register

Size: 8 bit		Default: 00h		Power Well: Core
Access		PCI Configuration		B:D:F 0:27:0
Offset Start: 4Ch		Offset End: 4Ch		
Bit Range	Default	Access	Acronym	Description
07:01	0	RO	RSVD	Reserved
00	0	RW/RO	DA	<p>Dock Attach: Software writes a 1 to this bit to initiate the docking sequence on the HDA_DOCK_EN_B and HDA_DOCKRST_B signals. When the docking sequence is complete hardware will set the Dock Mated (DCKSTS.DM) status bit to 1.</p> <p>Software writes a 0 to this bit to initiate the undocking sequence on the HDA_DOCK_EN_B and HDA_DOCKRST_B signals. When the undocking sequence is complete hardware will set the Dock Mated (DCKSTS.DM) status bit to 0.</p> <p>Note that software must check the state of the Dock Mated (DCKSTS.DM) bit prior to writing to the Dock Attach bit. Software shall only change the DA bit from 0 to 1 when DM=0. Likewise, software shall only change the DA bit from 1 to 0 when DM=1. If these rules are violated, the results are undefined.</p> <p>Note that this bit is reset on RESET_B. This bit is not reset on CRST_B.</p> <p>Note that this bit is Read Only when the DCKSTS.DS bit = 0.</p>

9.3.1.19 Offset 4Dh – DCKSTS—Docking Status Register

Table 196. 4Dh: DCKSTS – Docking Status Register

Size: 8 bit		Default: 80h		Power Well: Core
Access		PCI Configuration		B:D:F 0:27:0
Offset Start: 4Dh		Offset End: 4Dh		
Bit Range	Default	Access	Acronym	Description
07	1	RWO	DS	<p>Docking Supported: A 1 indicates that the processor supports Intel® HD Audio^β Docking. The DCKCTL.DA bit is only writable when this DS bit is 1. Intel® HD Audio^β driver software should only branch to its docking routine when this DS bit is 1. BIOS may clear this bit to 0 to prohibit the Intel® HD Audio^β driver software from attempting to run the docking routines.</p> <p>Note that this bit is reset to its default value only on a RESET_B, but not on a CRST_B or D3hot-to-D0 transition.</p>
06:01	0	RO	RSVD	Reserved
00	0	RO	DM	<p>Dock Mated: This bit effectively communicates to software that an Intel® HD Audio^β docked codec is physically and electrically attached. Controller hardware sets this bit to 1 after the docking sequence triggered by writing a 1 to the Dock Attach (DCKCTL.DA) bit is completed (HDA_DOCKRST_B deassertion). This bit indicates to software that the docked codec(s) may be discovered via the STATESTS register and then enumerated.</p> <p>Controller hardware sets this bit to 0 after the undocking sequence triggered by writing a 0 to the Dock Attach (DCKCTL.DA) bit is completed (HDA_DOCK_EN_B deasserted). This bit indicates to software that the docked codec(s) may be physically undocked.</p> <p>Note that this bit is reset on RST_B. It is not directly reset on CRST_B, however because the dock state machine is reset on CRST_B and the dock will be electrically isolated, this DM bit will be read as '0' reflecting the undocked state.</p> <p>This bit is Read Only. Writes to this bit have no effect.</p>



9.3.1.20 Offset 50h: PM_CAPID - PCI Power Management Capability ID Register

Table 197. 50h: PM_CAPID - PCI Power Management Capability ID Register

Size: 16 bit		Default: 7001h		Power Well: Core
Access		PCI Configuration B:D:F 0:27:0		Offset Start: 50h Offset End: 51h
Bit Range	Default	Access	Acronym	Description
15 : 08	70h	RO	NEXT	Next Capability: Points to the next capability structure (PCI Express*).
07 : 00	01h	RO	CAP	Cap ID: Indicates that this pointer is a PCI power management capability

9.3.1.21 Offset 52h: PM_CAP – Power Management Capabilities Register

Table 198. 52h: PM_CAP – Power Management Capabilities Register

Size: 16 bit		Default: 4802h		Power Well: Core
Access		PCI Configuration B:D:F 0:27:0		Offset Start: 52h Offset End: 53h
Bit Range	Default	Access	Acronym	Description
15 : 11	01001	RO		PME Support: Indicates PME_B can be generated from D3 _{HOT} and D0 states.
10 : 03	0	RO	RSVD	Reserved
02 : 00	010	RO	VS	Version: Indicates support for Revision 1.1 of the <i>PCI Power Management Specification</i> .

9.3.1.22 Offset 54h: PM_CTL_STS - Power Management Control And Status Register

Table 199. 54h: PM_CTL_STS - Power Management Control And Status Register (Sheet 1 of 2)

Size: 32 bit		Default: 0000h		Power Well: Core
Access		PCI Configuration B:D:F 0:27:0		Offset Start: 54h Offset End: 57h
Bit Range	Default	Access	Acronym	Description
31 : 16	0	RO	RSVD	Reserved
15	0	RWC	PMES	PME Status: 0 = Software clears the bit by writing a 1 to it. 1 = This bit is set when the Intel® HD Audio ^β controller would normally assert the PME_B signal independent of the state of the PME_EN bit (bit 8 in this register)
14 : 09	0	RO	RSVD	Reserved
08	0	RW	PMEE	PME Enable: 0 = Disable 1 = If corresponding PMES also set, the Intel® HD Audio ^β controller sets the generates an internal power management event.



Table 199. 54h: PM_CTL_STS - Power Management Control And Status Register (Sheet 2 of 2)

Size: 32 bit		Default: 0000h		Power Well: Core
Access		PCI Configuration		B:D:F 0:27:0
Offset Start: 54h Offset End: 57h				
Bit Range	Default	Access	Acronym	Description
07 : 02	0	RO	RSVD	Reserved
01 : 00	00	RO	PS	<p>Power State: This field is used both to determine the current power state of the Intel® HD Audio^β controller and to set a new power state. The values are: 00 = D0 state 11 = D3_{HOT} state Others = Reserved</p> <p>Notes: If software attempts to write a value of 01b or 10b in to this field, the write operation must complete normally; however, the data is discarded and no state change occurs. When in the D3_{HOT} states, the Intel® HD Audio^β controller's configuration space is available, but the I/O and memory spaces are not. Additionally, interrupts are blocked. When software changes this value from the D3_{HOT} state to the D0 state, an internal warm (soft) reset is generated, and software must re-initialize the function.</p>

9.3.1.23 Offset 60h: MSI_CAPID - MSI Capability ID Register

Table 200. 60h: MSI_CAPID - MSI Capability ID Register

Size: 16 bit		Default: 0005h		Power Well: Core
Access		PCI Configuration		B:D:F 0:27:0
Offset Start: 60h Offset End: 61h				
Bit Range	Default	Access	Acronym	Description
15 : 08	00h	RO	NEXT	Next Capability: Points to the next item in the capability list. Wired to 00h to indicate this is the last capability in the list.
07 : 00	05h	RO	CAP	Cap ID: Indicates that this pointer is a MSI capability

9.3.1.24 Offset 62h: MSI_CTL - MSI Message Control Register

Table 201. 62h: MSI_CTL - MSI Message Control Register

Size: 16 bit		Default: 0h		Power Well: Core
Access		PCI Configuration		B:D:F 0:27:0
Offset Start: 62h Offset End: 63h				
Bit Range	Default	Access	Acronym	Description
15 : 01	0	RO	RSVD	Reserved
00	0	RW	ME	<p>MSI Enable: 0 = An MSI may not be generated 1 = An MSI will be generated instead of an INTx signal</p>

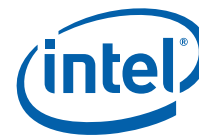

9.3.1.25 Offset 64h: MSI_ADR - MSI Message Address Register

Table 202. 64h: MSI_ADR - MSI Message Address Register

Size: 32 bit		Default: 0000_0000h		Power Well: Core
Access		PCI Configuration B:D:F 0:27:0		Offset Start: 64h Offset End: 67h
Bit Range	Default	Access	Acronym	Description
31 :02	0	RW	MLA	Message Lower Address: Lower Address used for MSI Message.
01 :00	0	RO	RSVD	Reserved

9.3.1.26 Offset 68h: MSI_DATA - MSI Message Data Register

Table 203. 68h: MSI_DATA - MSI Message Data Register

Size: 16 bit		Default: 0000h		Power Well: Core
Access		PCI Configuration B:D:F 0:27:0		Offset Start: 68h Offset End: 69h
Bit Range	Default	Access	Acronym	Description
15 :00	0	RW	MD	Message Data: Data used for MSI Message.

9.3.1.27 Offset 70h: PCIE_CAPID – PCI Express* Capability Identifiers Register

Table 204. 70h: PCIE_CAPID – PCI Express* Capability Identifiers Register

Size: 16 bit		Default: 10h		Power Well: Core
Access		PCI Configuration B:D:F 0:27:0		Offset Start: 70h Offset End: 71h
Bit Range	Default	Access	Acronym	Description
15 :08	60h/00h	RO	NEXT	Next Capability: Defaults to 60h, the address of the next capability structure in the list. However, if the FD.MD bit is set, the MSI capability will be disabled and this register will report 00h indicating this capability is the last capability in the list.
07 :00	10h	RO	CAP	Cap ID: Indicates that this pointer is a PCI Express* capability structure.

9.3.1.28 Offset 72h: PCIECAP – PCI Express* Capabilities Register

Table 205. 72h: PCIECAP – PCI Express* Capabilities Register (Sheet 1 of 2)

Size: 16 bit		Default: 0091h		Power Well: Core
Access		PCI Configuration B:D:F 0:27:0		Offset Start: 72h Offset End: 73h
Bit Range	Default	Access	Acronym	Description
15 :08	00	RO	RO	Reserved



Table 205. 72h: PCIECAP – PCI Express* Capabilities Register (Sheet 2 of 2)

Size: 16 bit		Default: 0091h		Power Well: Core
Access		PCI Configuration		B:D:F 0:27:0
Offset Start: 72h Offset End: 73h				
Bit Range	Default	Access	Acronym	Description
07 : 04	1001		RO	Device/Port Type: Indicates that this is a Root Complex Integrated Endpoint Device.
03 : 00	0001	RO	RO	Capability Version: Indicates version 1.0a PCI Express* capability

9.3.1.29 Offset 74h: DEVCAP – Device Capabilities Register

Table 206. 74h: DEVCAP – Device Capabilities Register

Size: 32 bit		Default: 0000_0000h		Power Well: Core
Access		PCI Configuration		B:D:F 0:27:0
Offset Start: 74h Offset End: 77h				
Bit Range	Default	Access	Acronym	Description
31 : 00	0	RO	RSVD	Reserved

9.3.1.30 Offset 78h: DEVC – Device Control

Table 207. 78h: DEVC – Device Control

Size: 16 bit		Default: 0800h		Power Well: Core
Access		PCI Configuration		B:D:F 0:27:0
Offset Start: 78h Offset End: 79h				
Bit Range	Default	Access	Acronym	Description
15	0	RO	RSVD	Reserved
14 : 12	000	RO	MRRS	Max Read Request Size: Hardwired to 000 enabling 128 B maximum read request size.
11	1	RW	NSNPEN	Enable No Snoop: 0 = The Intel® HD Audio ^β controller will not set the No Snoop bit. In this case, isochronous transfers will not use VC1 (VCi) even if it is enabled since VC1 is never snooped. Isochronous transfers will use VC0. 1 = The Intel® HD Audio ^β controller is permitted to set the No Snoop bit in the Requester Attributes of a bus master transaction. In this case, VC0 or VC1 may be used for isochronous transfers. Note: This bit is not reset on D3 _{HOT} to D0 transition.
10 : 04	0	RO	RSVD	Reserved
03	0	RW	URREN	Unsupported Request Reporting Enable: Functionality not implemented. This bit is RW to pass PCIe* compliance testing.
02	0	RW	FEREN	Fatal Error Reporting Enable: Functionality not implemented. This bit is RW to pass PCIe* compliance testing.
01	0	RW	NFEREN	Non-Fatal Error Reporting Enable: Functionality not implemented. This bit is RW to pass PCIe* compliance testing.
00	0	RW	CEREN	Correctable Error Reporting Enable: Functionality not implemented. This bit is RW to pass PCIe* compliance testing.

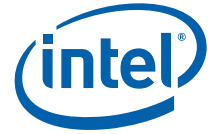

9.3.1.31 Offset 7Ah: DEVS – Device Status Register

Table 208. 7Ah: DEVS – Device Status Register

Size: 16 bit		Default: 0000h		Power Well: Core
Access		PCI Configuration B:D:F 0:27:0		Offset Start: 7Ah Offset End: 7Bh
Bit Range	Default	Access	Acronym	Description
15 :06	0	RO	RSVD	Reserved
05	0	RO	TXP	Transactions Pending: 0 = Completions for all Non-Posted Requests have been received. 1 = The Intel® HD Audio ^β controller has issued Non-Posted requests which have not been completed.
04 :00	0	RO	RSVD	Reserved

9.3.1.32 Offset FCh – FD: Function Disable Register

Table 209. FCh – FD: Function Disable Register

Size: 32 bit		Default: 0000_0000h		Power Well: Core
Access		PCI Configuration B:D:F 0:27:0		Offset Start: FCh Offset End: FFh
Bit Range	Default	Access	Acronym	Description
31 :03	0	RO	RSVD	Reserved
02	0	RW	GCD	Clock Gating Disable: 0 = Clock gating within the device is enabled (Default) 1 = Clock gating within the device is disabled.
01	0	RW	MD	MSI Disable: 0 = The MSI capability is visible. The NXT_PTR2 register will contain 60h. 1 = The MSI capability is disabled. The NXT_PTR2 register will contain 00h, indicating it's the last capability in the list.
00	0	RW	D	Disable: 1 = D27:F0 is disabled.

9.3.1.33 Offset 100h: VCCAP – Virtual Channel Enhanced Capability Header

Table 210. 100h: VCCAP – Virtual Channel Enhanced Capability Header

Size: 32 bit		Default: 1301_0002h		Power Well: Core
Access		PCI Configuration B:D:F 0:27:0		Offset Start: 100h Offset End: 103h
Bit Range	Default	Access	Acronym	Description
31 :20	130h	RO	NXTCAP	Next Capability Offset: Points to the next capability header, which is the Root Complex Link Declaration Enhanced Capability Header
19 :16	1h	RO		Capability Version
15 :00	0002h	RO		PCI Express* Extended Capability

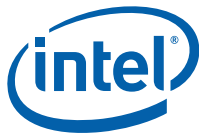

9.3.1.34 Offset 104h: PVCCAP1 – Port VC Capability Register 1

Table 211. 104h: PVCCAP1 – Port VC Capability Register 1

Size: 32 bit		Default: 0000_0001h		Power Well: Core
Access		PCI Configuration		Offset Start: 104h Offset End: 107h
		B:D:F 0:27:0		
Bit Range	Default	Access	Acronym	Description
31 : 03	0	RO	RSVD	Reserved
02 : 00	001	RO	VCCNT	Extended VC Count: Indicates that one extended VC (in addition to VCO) is supported by the Intel® HD Audio ^β controller.

9.3.1.35 Offset 108h: PVCCAP2 – Port VC Capability Register 2

Table 212. 108h: PVCCAP2 – Port VC Capability Register 2

Size: 32 bit		Default: 0000 0000h		Power Well: Core
Access		PCI Configuration		Offset Start: 108h Offset End: 10Bh
		B:D:F 0:27:0		
Bit Range	Default	Access	Acronym	Description
31 : 00	0	RO	RSVD	Reserved

9.3.1.36 Offset 10Ch: PVCCTL – Port VC Control Register

Table 213. 10Ch: PVCCTL – Port VC Control Register

Size: 16 bit		Default: 00000h		Power Well: Core
Access		PCI Configuration		Offset Start: 10Ch Offset End: 10Dh
		B:D:F 0:27:0		
Bit Range	Default	Access	Acronym	Description
15 : 00	0	RO	RSVD	Reserved

9.3.1.37 Offset 10Eh: PVCSTS – Port VC Status Register

Table 214. 10Eh: PVCSTS – Port VC Status Register

Size: 16 bit		Default: 0000h		Power Well: Core
Access		PCI Configuration		Offset Start: 10Eh Offset End: 10Fh
		B:D:F 0:27:0		
Bit Range	Default	Access	Acronym	Description
15 : 00	0	RO	RSVD	Reserved



9.3.1.38 Offset 110h: VC0CAP – VC0 Resource Capability Register

Table 215. 110h: VC0CAP – VC0 Resource Capability Register

Size: 32 bit		Default: 0000 0000h		Power Well: Core
Access		PCI Configuration B:D:F 0:27:0		Offset Start: 110h Offset End: 113h
Bit Range	Default	Access	Acronym	Description
31 :00	0	RO	RSVD	Reserved

9.3.1.39 Offset 114h: VC0CTL – VC0 Resource Control Register

Table 216. 114h: VC0CTL – VC0 Resource Control Register

Size: 32 bit		Default: 8000 00FFh		Power Well: Core
Access		PCI Configuration B:D:F 0:27:0		Offset Start: 114h Offset End: 117h
Bit Range	Default	Access	Acronym	Description
31	1	RO	VC0EN	VC0 Enable: Hardwired to 1 for VC0.
30 :08	0	RO	RSVD	Reserved
07 :00	FFh	RW/RO	VC0MAP	TC/VC0 Map: Bit 0 is hardwired to 1 since TC0 is always mapped to VC0. Bits [7:1] are implemented as RW bits.

9.3.1.40 Offset 11Ah: VC0STS – VC0 Resource Status Register

Table 217. 11Ah: VC0STS – VC0 Resource Status Register

Size: 16 bit		Default: 0000h		Power Well: Core
Access		PCI Configuration B:D:F 0:27:0		Offset Start: 11Ah Offset End: 11Bh
Bit Range	Default	Access	Acronym	Description
15 :00	0	RO	RSVD	Reserved

9.3.1.41 Offset 11Ch: VC1CAP – VC1 Resource Capability Register

Table 218. 11Ch: VC1CAP – VC1 Resource Capability Register

Size: 32 bit		Default: 0000_0000h		Power Well: Core
Access		PCI Configuration B:D:F 0:27:0		Offset Start: 11Ch Offset End: 11Fh
Bit Range	Default	Access	Acronym	Description
31 :00	0	RO	RSVD	Reserved



9.3.1.42 Offset 120h: VC1CTL – VC1 Resource Control Register

Table 219. 120h: VC1CTL – VC1 Resource Control Register

Size: 32 bit		Default: 0000_0000h		Power Well: Core
Access		PCI Configuration		B:D:F 0:27:0
Offset Start: 120h		Offset End: 123h		
Bit Range	Default	Access	Acronym	Description
31	0	RW	VC1EN	VC1 Enable: 0 = VC1 is disabled 1 = VC1 is enabled Note: This bit is not reset on D3 _{HOT} to D1 transition.
30 : 27	0	RO	RSVD	Reserved
26 : 24	000	RW	VC1ID	VC1 ID: This field assigns a VC ID to the VC1 resource. This field is not used by the processor, but it is RW to avoid confusing software.
23 : 08	0	RO	RSVD	Reserved
07 : 00	00h	RW/RO		TC/VC Map: This field indicates the TCs that are mapped to the VC1 resource. Bit 0 is hardwired to 0 indicating it can not be mapped to VC1. Bits [7:1] are implemented as RW bits. This field is not used by the processor, but it is RW to avoid confusing software.

9.3.1.43 Offset 126h: VC1STS – VC1 Resource Status Register

Table 220. 126h: VC1STS – VC1 Resource Status Register

Size: 16 bit		Default: 0000h		Power Well: Core
Access		PCI Configuration		B:D:F 0:27:0
Offset Start: 126h		Offset End: 127h		
Bit Range	Default	Access	Acronym	Description
15 : 00	0	RO	RSVD	Reserved

9.3.1.44 Offset 130h: RCCAP – Root Complex Link Declaration Enhanced Capability Header Register

Table 221. 130h: RCCAP – Root Complex Link Declaration Enhanced Capability Header Register

Size: 32 bit		Default: 0001_0005h		Power Well: Core
Access		PCI Configuration		B:D:F 0:27:0
Offset Start: 130h		Offset End: 133h		
Bit Range	Default	Access	Acronym	Description
31 : 20	000h	RO	NXTCAP	Next Capability Offset: Indicates this is the last capability.
19 : 16	1h	RO		Capability Version
15 : 00	0005h	RO		PCI Express* Extended Capability ID

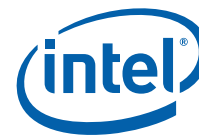

9.3.1.45 Offset 134h: ESD – Element Self Description Register

Table 222. 134h: ESD – Element Self Description Register

Size: 32 bit		Default: 0F00_0100h		Power Well: Core
Access		PCI Configuration		Offset Start: 134h Offset End: 137h
		B:D:F 0:27:0		
Bit Range	Default	Access	Acronym	Description
31 : 24	0Fh	RO	PORT	Port Number: Intel® HD Audio ^β assigned as Port _B15.
23 : 16	00h	RO	COMPID	Component ID: This field returns the value of the ESD.CID field of the chip configuration section. ESD.CID is programmed by BIOS.
15 : 08	01h	RO	LNKENT	Number of Link Entries: The Intel® HD Audio ^β controller only connects to one device, the processor egress port. Therefore this field reports a value of 1h.
07 : 04	0h	RO	RSVD	Reserved
03 : 00	0h	RO	ELTYP	Element Type: The Intel® HD Audio ^β controller is an Integrated Root Complex Device. Therefore this field reports a value of 0h.

9.3.1.46 Offset 140h: L1DESC – Link 1 Description Register

Table 223. 140h: L1DESC – Link 1 Description Register

Size: 32 bit		Default: 0000_0001		Power Well: Core
Access		PCI Configuration		Offset Start: 140h Offset End: 143h
		B:D:F 0:27:0		
Bit Range	Default	Access	Acronym	Description
31 : 24	00h	RO	TPORT	Target Port Number: The Intel® HD Audio ^β controller targets the processor RCRB egress port, which is port _B0.
23 : 16	Variable	RO	TCOMPID	Target Component ID: This field returns the value of the ESD.COMPID field of the chip configuration section. ESD.COMPID is programmed by BIOS.
15 : 02	0h	RO	RSVD	Reserved
01	0	RO	LNKTYP	Link Type: Indicates Type 0.
00	1	RO	LNKVLD	Link Valid: Hardwired to 1.

9.3.1.47 Offset 148h: L1ADD – Link 1 Address Register

Table 224. 148h: L1ADD – Link 1 Address Register

Size: 32 bit		Default: Variable		Power Well: Core
Access		PCI Configuration		Offset Start: 148h Offset End: 14Bh
		B:D:F 0:27:0		
Bit Range	Default	Access	Acronym	Description
31 : 14	Variable	RW	RCBA R/W	Base (BASE): Hardwired to match the RCBA register value in the PCI-LPC bridge (D31:F0h).
13 : 00	0h	RO	RSVD	Reserved



9.3.2 Memory Mapped Configuration Registers

9.3.2.1 Intel® HD Audio^β Registers

The base memory location for these memory mapped configuration registers is specified in the LBAR and UBAR (D27:F0 - offset 10h and D27:F0 - offset 14h) registers. The individual registers are then accessible at LBAR + Offset as indicated in the following table.

These memory mapped registers must be accessed a byte, word, or Dword quantities. Addresses not shown must be treated as reserved.

Table 225. Intel® HD Audio^β Register Summary (Sheet 1 of 3)

Offset Start	Offset End	Symbol	Full Name	Reset Value	Access
00	01	GCAP	Global Capabilities	4401h	RO
02	02	VMIN	Minor Version	00h	RO
03	03	VMAJ	Major Version	01h	RO
04	05	OUTPAY	Output Payload Capability	003Ch	RO
06	07	INPAY	Input Payload Capability	001Dh	RO
08	0B	GCTL	Global Control	0000h	RO, R/W
0C	0C	WAKEEN	Wake Enable	0000h	RO, R/W
0E	0E	STATESTS	State Change Status	0000h	RO, RWC
10	11	GSTS	Global Status	0000h	RO, RWC
18	1B	STRMPAY	Stream Payload Capability (Input and Output)	0018_0030	RO
20	23	INTCTL	Interrupt Control	0000_0000h	RW, RO
24	27	INTSTS	Interrupt Status	0000_0000h	RO
30	33	WALCLK	Wall Clock Counter	0000_0000h	RO
38	3B	SSYNC	Stream Synchronization	0000_0000h	RW, RO
40	43	CORBBASE	CORB Base Address	0000_0000h	RW, RO
48	49	CORBWP	CORB Write Pointer	0000h	RW, RO
4A	4B	CORBWP	CORB Read Pointer	0000h	RW, RO
4C	4C	CORBCTL	CORB Control	00h	RW, RO
4D	4D	CORBSTS	CORB Status	00h	RW, RO
4E	4E	CORBSIZE	CORB Size	42h	RO
50	53	RIRBBASE	RIRB Base Address	0000_0000h	RW, RO
58	59	RIRBWP	RIRB Write Pointer	0000h	WO, RO
5A	5B	RINTCNT	Response Interrupt Count	0000h	RW, RO
5C	5C	RIRBCTL	RIRB Control	00h	RW, RO
5D	5D	RIRBSTS	RIRB Status	00h	RWC, RO
5E	5E	RIRBSIZE	RIRB Size	40h	RO
60	63	IC	Immediate Command	0000_0000h	RW
64	67	IR	Immediate Response	0000_0000h	RO
68	69	ICS	Immediate Command Status	0000h	RW, RWC, RO
70	73	DPBASE	DMA Position Base Address	0000_0000h	RW, RO
80	82	ISDOCTL	Input Stream Descriptor 0 (ISD0) Control	04_0000h	RW, RO

Table 225. Intel® HD Audio^β Register Summary (Sheet 2 of 3)

Offset Start	Offset End	Symbol	Full Name	Reset Value	Access
83	83	ISD0STS	ISD0 Status	00h	RWC, RO
84	87	ISD0LPIB	ISD0 Link Position in Buffer	0000_0000h	RO
88	8B	ISD0CBL	ISD0 Cyclic Buffer Length	0000_0000h	RW
8C	8D	ISD0LVI	ISD0 Last Valid Index	0000h	RW, RO
8E	8F	ISD0FIFOW	ISD0 FIFO Watermark	0004h	RW, RO
90	91	ISD0FIFOS	ISD0 FIFO Size	0077h	RO
92	93	ISD0FMT	ISD0 Format	0000h	RW, RO
98	9B	ISD0BDPL	ISD0 Buffer Descriptor List Pointer	0000_0000h	RW, RO, WO
A0	A2	ISD1CTL	Input Stream Descriptor 1 (ISD1) Control	04_0000h	RW, RO
A3	A3	ISD1STS	ISD1 Status	00h	RWC, RO
A4	A7	ISD1LPIB	ISD1 Link Position in Buffer	0000_0000h	RO
A8	AB	ISD1CBL	ISD1 Cyclic Buffer Length	0000_0000h	RW
AC	AD	ISD1LVI	ISD1 Last Valid Index	0000h	RW, RO
AE	AF	ISD1FIFOW	ISD1 FIFO Watermark	0004h	RW, RO
B0	B1	ISD1FIFOS	ISD1 FIFO Size	0077h	RO
B2	B3	ISD1FMT	ISD1 Format	0000h	RW, RO
B8	BB	ISD1BDPL	ISD1 Buffer Descriptor List Pointer	0000_0000h	RW, RO, WO
C0	C2	OSD0CTL	Output Stream Descriptor 0 (OSD0) Control	04_0000h	RW, RO
C3	C3	OSD0STS	OSD0 Status	00h	RWC, RO
C4	C7	OSD0LPIB	OSD0 Link Position in Buffer	0000_0000h	RO
C8	CB	OSD0CBL	OSD0 Cyclic Buffer Length	0000_0000h	RW
CC	CD	OSD0LVI	OSD0 Last Valid Index	0000h	RW, RO
CE	CF	OSD0FIFOW	OSD0 FIFO Watermark	0004h	RW, RO
D0	D1	OSD0FIFOS	OSD0 FIFO Size	00BFh	RW, RO
D2	D3	OSD0FMT	OSD0 Format	0000h	RW, RO
D8	DB	OSD0BDPL	OSD0 Buffer Descriptor List Pointer	0000_0000h	RW, RO, WO
E0	E2	OSD1CTL	Output Stream Descriptor 1 (OSD1) Control	04_0000h	RW, RO
E3	E3	OSD1STS	OSD1 Status	00h	RWC, RO
E4	E7	OSD1LPIB	OSD1 Link Position in Buffer	0000_0000h	RO
E8	EB	OSD1CBL	OSD1 Cyclic Buffer Length	0000_0000h	RW
EC	ED	OSD1LVI	OSD1 Last Valid Index	0000h	RW, RO
EE	EF	OSD1FIFOW	OSD1 FIFO Watermark	0004h	RW, RO
F0	F1	OSD1FIFOS	OSD1 FIFO Size	00BFh	RW, RO
F2	F3	OSD1FMT	OSD1 Format	0000h	RW, RO
F8	FB	OSD1BDPL	OSD1 Buffer Descriptor List Pointer	0000_0000h	RW, RO, WO
Vendor Specific Memory Mapped Registers					
1000	1003	EM1	Extended Mode 1	0C00_0000h	RW, RO
1004	1007	INRC	Input Stream Repeat Count	0000_0000h	RO
1008	100B	OUTRC	Output Stream Repeat Count	0000_0000h	RO
100C	100F	FIFOTRK	FIFO Tracking	000F_F800h	RO, RW



Table 225. Intel® HD Audio^β Register Summary (Sheet 3 of 3)

Offset Start	Offset End	Symbol	Full Name	Reset Value	Access
1010	1013	I0DPIB	Input Stream 0 DMA Position in Buffer	0000_0000h	RO
1014	1017	I1DPIB	Input Stream 1 DMA Position in Buffer	0000_0000h	RO
1020	1023	O0DPIB	Output Stream 0 DMA Position in Buffer	0000_0000h	RO
1024	1027	O1DPIB	Output Stream 1 DMA Position in Buffer	0000_0000h	RO
1030	1033	EM2	Extended Mode 2	0000_0000h	RW, RO
2030	2033	WLCLKA	Wall Clock Counter Alias	0000_0000h	RO
2084	2087	ISD0LPIBA	ISD0 Link Position in Buffer Alias	0000_0000h	RO
20A4	20A7	ISD1LPIBA	ISD1 Link Position in Buffer Alias	0000_0000h	RO
2104	2107	OSD0LPIBA	OSD0 Link Position in Buffer Alias	0000_0000h	RO
2124	2127	OSD1LPIBA	OSD1 Link Position in Buffer Alias	0000_0000h	RO

9.3.2.1.1 Offset 00h: GCAP – Global Capabilities Register

Table 226. 00h: GCAP – Global Capabilities Register

Size: 16 bit		Default: 4401h		Power Well: Core
Access	PCI Configuration		B:D:F 0:27:0	Offset Start: 00h Offset End: 01h
	Memory Mapped IO		BAR: LBAR	Offset:
Bit Range	Default	Access	Acronym	Description
15 : 12	0010	RO	OSS	Number of Output Streams Supported: 0010b indicates that the processor Intel® HD Audio ^β controller supports two output streams.
11 : 08	0010	RO	ISS	Number of Input Streams Supported: 0010b indicates that the processor Intel® HD Audio ^β controller supports two output streams.
07 : 03	00000	RO	BSS	Number of Bidirectional Streams Supported: 00000b indicates that the processor Intel® HD Audio ^β controller supports 0 bidirectional streams.
02	0	RO	RSVD	Reserved
01	0	RO	NSDO	Number of Serial Data Out Signals: 00b indicates that the processor Intel® HD Audio ^β controller supports one Serial Data Output signal.
00	0	RO		64 Bit Address Supported: A 1 indicates that the processor Intel® HD Audio ^β controller supports 64-bit addressing for BDL addresses, data buffer addresses, and command buffer addresses.

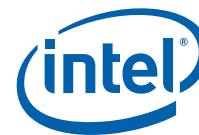

9.3.2.1.2 Offset 02h: VMIN – Minor Version Register

Table 227. 02h: VMIN – Minor Version Register

Size: 8 bit		Default: 00h		Power Well: Core
Access		PCI Configuration B:D:F 0:27:0		Offset Start: 02h Offset End: 02h
		Memory Mapped IO BAR: LBAR		Offset:
Bit Range	Default	Access	Acronym	Description
07 : 00	00h	RO	VMIN	Minor Version: Indicates that the processor supports minor revision number 00h of the Intel® HD Audio [®] specification.

9.3.2.1.3 Offset 03h: VMAJ – Major Version

Table 228. 03h: VMAJ – Major Version

Size: 8 bit		Default: 01h		Power Well: Core
Access		PCI Configuration B:D:F 0:27:0		Offset Start: 03h Offset End: 03h
		Memory Mapped IO BAR: LBAR		Offset:
Bit Range	Default	Access	Acronym	Description
07 : 00	01h	RO	VMAJ	Major Version: Indicates that the processor supports major revision number 1 of the Intel® HD Audio [®] specification.

9.3.2.1.4 Offset 04h: OUTPUTPAY – Output Payload Capability Register

Table 229. 04h: OUTPUTPAY – Output Payload Capability Register

Size: 16 bit		Default: 003Ch		Power Well: Core
Access		PCI Configuration B:D:F 0:27:0		Offset Start: 04h Offset End: 05h
		Memory Mapped IO BAR: LBAR		Offset:
Bit Range	Default	Access	Acronym	Description
15 : 07	0	RO	RSVD	Reserved
06 : 00	3Ch	RO	OUTPUTPAY	Output Payload Capability: Indicates the total output payload available on the link. This does not include bandwidth used for command and control. This measurement is in 16-bit word quantities per 48 kHz frame. The default link clock speed of 24.000 MHz (the data is double pumped) provides 1000 bits per frame, or 62.5 words in total. 40 bits are used for command and control, leaving 60 words available for data payload. 00h: 0 words 01h: 1 word payload ... FFh: 255h word payload

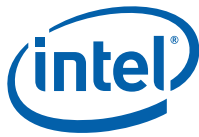

9.3.2.1.5 Offset 06h: INPAY – Input Payload Capability Register

Table 230. 06h: INPAY – Input Payload Capability Register

Size: 16 bit		Default: 001Dh		Power Well: Core
Access		PCI Configuration B:D:F 0:27:0		Offset Start: 06h Offset End: 07h
		Memory Mapped IO BAR: LBAR		Offset:
Bit Range	Default	Access	Acronym	Description
15 :07	0	RO	RSVD	Reserved
06 :00	1Dh	RO	INPAY	Input Payload Capability: Indicates the total input payload available on the link. This does not include bandwidth used for response. This measurement is in 16-bit word quantities per 48 kHz frame. The default link clock speed of 24.000 MHz provides 500 bits per frame, or 31.25 words in total. 36 bits are used for response, leaving 29 words for data payload. 00h: 0 words 01h: 1 word payload ... FFh: 255h word payload

9.3.2.1.6 Offset 08h: GCTL – Global Control

Table 231. 08h: GCTL – Global Control (Sheet 1 of 2)

Size: 32 bit		Default: 0000_0000h		Power Well: Core
Access		PCI Configuration B:D:F 0:27:0		Offset Start: 08h Offset End: 0Bh
		Memory Mapped IO BAR: LBAR		Offset:
Bit Range	Default	Access	Acronym	Description
31 :09	0	RO	RSVD	Reserved
08	0	RW	UNSOL	Accept Unsolicited Response Enable: 0 = Unsolicited responses from the codecs are not accepted. 1 = Unsolicited response from the codecs are accepted by the controller and placed into the Response Input Ring Buffer.
07 :02	0	RO	RSVD	Reserved
01	0	RW	FCNTRL	Flush Control: Writing a 1 to this bit initiates a flush. When the flush completion is received by the controller, hardware sets the Flush Status bit and clears this Flush Control bit. Before a flush cycle is initiated, the DMA Position Buffer must be programmed with a valid memory address by software, but the DMA Position Buffer bit 0 need not be set to enable the position reporting mechanism. Also, all streams must be stopped (the associated RUN bit must be 0). When the flush is initiated, the controller will flush pipelines to memory to guarantee that the hardware is ready to transition to a D3 state. Setting this bit is not a critical step in the power state transition if the content of the FIFOs is not critical.



Table 231. 08h: GCTL – Global Control (Sheet 2 of 2)

Size: 32 bit		Default: 0000_0000h		Power Well: Core
Access		PCI Configuration B:D:F 0:27:0		Offset Start: 08h Offset End: 0Bh
		Memory Mapped IO BAR: LBAR		Offset:
Bit Range	Default	Access	Acronym	Description
00	0	RW	CRST_B	<p>Controller Reset #: 0 = Writing a 0 to this bit causes the Intel® HD Audio^β controller to be reset. All state machines, FIFO's and non-resume well memory mapped configuration registers (not PCI Configuration Registers) in the controller will be reset. The Intel® HD Audio^β link RESET_B signal will be asserted and all other link signals will be driven to their default values. After the hardware has completed sequencing into the reset state, it will report a 0 in this bit. Software must read a 0 from this bit to verify that the controller is in reset. 1 = Writing a 1 to this bit causes the controller to exit its reset state and deassert the Intel® HD Audio^β link RESET_B signal. Software is responsible for setting/clearing this bit such that the minimum Intel® HD Audio^β link RESET_B signal assertion pulse width specification is met. When the controller hardware is ready to begin operation, it will report a 1 in this bit. Software must read a 1 from this bit before accessing any controller registers. This bit defaults to a 0 after hardware reset, therefore, software needs to write a 1 to this bit to begin operation.</p> <p>Notes: The CORB/RIRB RUN bits and all Stream RUN bits must be verified cleared to zero before writing a 0 to this bit in order to assure a clean restart. When setting or clearing this bit, software must ensure that minimum link timing requirements (minimum RESET_B assertion time, etc.) are met. When this bit is 0 indicating that the controller is in reset, writes to all Intel® HD Audio^β memory mapped registers are ignored as if the device is not present. The only exception is the this register itself. The Global Control register is write-able as a DWord, Word, or Byte even when CRST_B (this bit) is 0 if the byte enable for the byte containing the CRST_B bit (Byte Enable 0) is active. If Byte Enable 0 is not active, writes to the Global Control register will be ignored when CRST_B is 0. When CRST_B is 0, reads to Intel® HD Audio^β memory mapped registers will return their default value except for registers that are not reset with RESET_B or on a D3hot -> D0 transition.</p>

9.3.2.1.7 Offset 0Ch: WAKEEN – Wake Enable

Table 232. 0Ch: WAKEEN – Wake Enable

Size: 16 bit		Default: 0000h		Power Well: Core
Access		PCI Configuration B:D:F 0:27:0		Offset Start: 0Ch Offset End: 0Dh
		Memory Mapped IO BAR: LBAR		Offset:
Bit Range	Default	Access	Acronym	Description
15 :02	0	RO	RSVD	Reserved
01 :00	0	RW, SUS	SDIWEN	<p>SDIN Wake Enable Flags (SDIWEN): These bits control which SDI signal(s) may generate a wake event. A 1 in the bit mask indicates that the associated SDIN signal is enabled to generate a wake. Bit 0 is for SDI0, Bit 1 is for SDI1 These bits are in the suspend well and only cleared on a power-on reset. Software must not make assumptions about the reset state of these bits and must set them appropriately.</p>



9.3.2.1.8 Offset 0Eh: STATESTS – State Change Status

Table 233. 0Eh: STATESTS – State Change Status

Size: 16 bit		Default: 0000h		Power Well: Core
Access		PCI Configuration	B:D:F 0:27:0	
		Memory Mapped IO	BAR: LBAR	
				Offset Start: 0Eh Offset End: 0Fh
				Offset:
Bit Range	Default	Access	Acronym	Description
15 :02	0	RO	RSVD	Reserved
01 :00	0	RWC	SDIWAKE	<p>SDIN State Change Status Flags: Flag bits that indicate which SDI signal(s) received a “State Change” event. The bits are cleared by writing a 1 to them.</p> <p>Bit 0 is for SDI0, Bit 1 is for SDI1 Bit 2 is for SDI2.</p> <p>These bits are in the suspend well and only cleared on a power-on reset. Software must not make assumptions about the reset state of these bits and must set them appropriately.</p>

9.3.2.1.9 Offset 10h: GSTS – Global Status

Table 234. 10h: GSTS – Global Status

Size: 16 bit		Default: 0000h		Power Well: Core
Access		PCI Configuration	B:D:F 0:27:0	
		Memory Mapped IO	BAR: LBAR	
				Offset Start: 10h Offset End: 11h
				Offset:
Bit Range	Default	Access	Acronym	Description
15 :04	0	RO	RSVD	Reserved
03	0	RWC	DMIS	<p>Dock Mated Interrupt Status: A 1 indicates that the dock mating or unmating process has completed. For the docking process it indicates that dock is electrically isolated and that software may report to the user that physical undocking may commence. This bit gets set to a 1 by hardware when the DM bit transitions from a 0 to a 1 (docking) or from a 1 to a 0 (undocking). Note that this bit is set regardless of the state of the DMIE bit.</p> <p>Software clears this bit by writing a 1 to it. Writing a 0 to this bit has no affect.</p>
02	0	RO	DM	<p>Dock Mated: This bit effectively communicates to software that an Intel® HD Audio[®] docked codec is physically and electrically attached. Controller hardware sets this bit to 1 after the docking sequence triggered by writing a 1 to the Dock Attach (GCTL.DA) bit is completed (HDA_DOCKRST_B deassertion). This bit indicates to software that the docked codec(s) may be discovered via the STATESTS register and then enumerated.</p> <p>Controller hardware sets this bit to 0 after the undocking sequence triggered by writing a 0 to the Dock Attach (GCTL.DA) bit is completed (HDA_DOCK_EN_B deasserted). This bit indicates to software that the docked codec(s) may be physically undocked.</p> <p>This bit is Read Only. Writes to this bit have no effect.</p>
01	0	RWC	FSTS	<p>Flush Status: This bit is set to a 1 by the hardware to indicate that the flush cycle initiated when the FCNTRL bit (LBAR+08h, bit 1) was set has completed. Software must write a 1 to clear this bit before the next time FCNTRL is set.</p>
00	0	RO	RSVD	Reserved

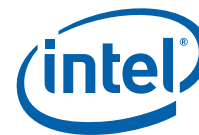

9.3.2.1.10 Offset 14h: ECAP - Extended Capabilities

Table 235. 14h: ECAP - Extended Capabilities

Size: 32 bit		Default: 0000_0000h		Power Well: Core
Access		PCI Configuration	B:D:F 0:27:0	Offset Start: 14h Offset End: 17h
		Memory Mapped IO	BAR: LBAR	Offset:
Bit Range	Default	Access	Acronym	Description
31 : 1	0	RO	RSVD	Reserved
0	0h	R/WO	DS	Docking Supported: A 1 indicates that processor supports Intel® HD Audio ^β Docking. The GCTL.DA bit is only writable when this bit is 1. This bit is reset to its default value only on RESET_B, but not on a CRST_B or D3 _{HOT} -to-D0 transition.

9.3.2.1.11 Offset 18h: STRMPAY – Stream Payload Capability Register

Table 236. 18h: STRMPAY – Stream Payload Capability Register

Size: 32 bit		Default: 0018_0030h		Power Well: Core
Access		PCI Configuration	B:D:F 0:27:0	Offset Start: 18h Offset End: 1Bh
		Memory Mapped IO	BAR: LBAR	Offset:
Bit Range	Default	Access	Acronym	Description
31 : 24	0	RO	RSVD	Reserved
23 : 16	18h	RO	IN	Input: Indicates the number of words per frame for the input streams is 24 words. This measurement is in 16 bit word quantities per 48kHz frame.
15 : 08	0	RO	RSVD	Reserved
07 : 00	30h	RO	OUT	Output: Indicates the number of words per frame for output streams is 48 words. This measurement is in 16-bit word quantities per 48kHz frame.



9.3.2.1.12 Offset 20h: INTCTL - Interrupt Control Register

Table 237. 20h: INTCTL - Interrupt Control Register

Size: 32 bit		Default: 0000_0000h		Power Well: Core
Access		PCI Configuration B:D:F 0:27:0		Offset Start: 20h Offset End: 23h
		Memory Mapped IO BAR: LBAR		Offset:
Bit Range	Default	Access	Acronym	Description
31	0	RW	GIE	Global Interrupt Enable: Global bit to enable device interrupt generation. When set to 1 the Intel® HD Audio [®] function is enabled to generate an interrupt. This control is in addition to any bits in the bus specific address space, such as the Interrupt Enable bit in the PCI Configuration Space. Note: This bit is not affected by the D3 _{HOT} to D0 transition.
30	0	RW	CIE	Controller Interrupt Enable: Enables the general interrupt for controller functions. When set to 1, the controller generates an interrupt when the corresponding status bit gets set due to a Response Interrupt, a Response Buffer Overrun, and State Change events. Note: This bit is not affected by the D3 _{HOT} to D0 transition.
29:04	0	RO	RSVD	Reserved
03:00	0h	RW	SIE	Stream Interrupt Enable: When set to 1 the individual Streams are enabled to generate an interrupt when the corresponding stream status (INTSTS) bits get set. The streams are numbered and the SIE bits assigned sequentially, based on their order in the register set. Bit 3: Output Stream 2 (OS2) Bit 2: Output Stream 1 (OS1) Bit 1: Input Stream 2 (IS2) Bit 0: Input Stream 1 (IS1)

9.3.2.1.13 Offset 24h: INTSTS - Interrupt Status Register

Table 238. 24h: INTSTS - Interrupt Status Register (Sheet 1 of 2)

Size: 32 bit		Default: 0000_0000h		Power Well: Core
Access		PCI Configuration B:D:F 0:27:0		Offset Start: 24h Offset End: 27h
		Memory Mapped IO BAR: LBAR		Offset:
Bit Range	Default	Access	Acronym	Description
31	0	RO	GIS	Global Interrupt Status: This bit is an OR of all of the interrupt status bits in this register. Note: This bit is not affected by the D3 _{HOT} to D0 transition.
30	0	RO	CIS	Controller Interrupt Status: Status of general controller interrupt. 1 = indicates that an interrupt condition occurred due to a Response Interrupt, a Response Buffer Overrun Interrupt or a SDIN State Change event. The exact cause can be determined by interrogating other registers. This bit is an OR of all of the stated interrupt status bits for this register. Note: This bit is set regardless of the state of the corresponding interrupt enable bit, but a hardware interrupt will not be generated unless the corresponding enable bit is set. This bit is not affected by the D3 _{HOT} to D0 transition.
29:04	0	RO	RSVD	Reserved

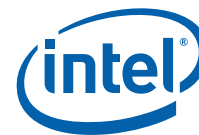

Table 238. 24h: INTSTS - Interrupt Status Register (Sheet 2 of 2)

Size: 32 bit		Default: 0000_0000h		Power Well: Core
Access		PCI Configuration B:D:F 0:27:0		Offset Start: 24h Offset End: 27h
		Memory Mapped IO BAR: LBAR		Offset:
Bit Range	Default	Access	Acronym	Description
03 :00	0h	RO	SIS	Stream Interrupt Status: A 1 indicates that an interrupt condition occurred on the corresponding Stream. Note that a HW interrupt will not be generated unless the corresponding enable bit is set. This bit is an OR of all of an individual stream's interrupt status bits. The streams are numbered and the SIS bits assigned sequentially, based on their order in the register set. Bit 3: Output Stream 2 (OS2) Bit 2: Output Stream 1 (OS1) Bit 1: Input Stream 2 (IS2) Bit 0: Input Stream 1 (IS1)

9.3.2.1.14 Offset 30h: WALCLK – Wall Clock Counter Register

The 32 bit monotonic counter provides a 'wall clock' that can be used by system software to synchronize independent audio controllers. The counter must be implemented.

Table 239. 30h: WALCLK – Wall Clock Counter Register

Size: 32 bit		Default: 0000_0000h		Power Well: Core
Access		PCI Configuration B:D:F 0:27:0		Offset Start: 30h Offset End: 33h
		Memory Mapped IO BAR: LBAR		Offset:
Bit Range	Default	Access	Acronym	Description
31 :00	0000_0000h	RO	Counter	Wall Clock Counter: 32 bit counter that is incremented on each link Bit Clock period and rolls over from FFFF_FFFFh to 0000_0000h. This counter will roll over to zero with a period of approximately 179 seconds. This counter is enabled while the Bit Clock bit is set to 1. Software uses this counter to synchronize between multiple controllers. Will be reset on controller reset.

9.3.2.1.15 Offset 38h: SSYNC –Stream Synchronization Register

Table 240. 38h: SSYNC –Stream Synchronization Register (Sheet 1 of 2)

Size: 32 bit		Default: 0000_0000h		Power Well: Core
Access		PCI Configuration B:D:F 0:27:0		Offset Start: 38h Offset End: 3Bh
		Memory Mapped IO BAR: LBAR		Offset:
Bit Range	Default	Access	Acronym	Description
31 :04	0	RO	RSVD	Reserved

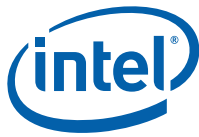

Table 240. 38h: SSYNC –Stream Synchronization Register (Sheet 2 of 2)

Size: 32 bit		Default: 0000_0000h		Power Well: Core
Access		PCI Configuration B:D:F 0:27:0		Offset Start: 38h Offset End: 3Bh
		Memory Mapped IO BAR: LBAR		Offset:
Bit Range	Default	Access	Acronym	Description
03 :00	0h	RW	SSYNC	<p>Stream Synchronization Bits: The Stream Synchronization bits, when set to 1, block data from being sent on or received from the link. Each bit controls the associated Stream Descriptor; bit 0 corresponds to the first Stream Descriptor, etc.</p> <p>To synchronously start a set of DMA engines, the bits in the SSYNC register are first set to a 1. The RUN bits for the associated Stream Descriptors are then set to a 1 to start the DMA engines. When all streams are ready (FIFORDY=1), the associated SSYNC bits can all be set to 0 at the same time, and transmission or reception of bits to or from the link will begin together at the start of the next full link frame.</p> <p>To synchronously stop streams, first the bits are set in the SSYNC register, and then the individual RUN bits in the Stream Descriptors are cleared by software.</p> <p>The streams are numbered and the SSYNC bits assigned sequentially, based on their order in the register set.</p> <p>Bit 3: Output Stream 2 (OS2) Bit 2: Output Stream 1 (OS1) Bit 1: Input Stream 2 (IS2) Bit 0: Input Stream 1 (IS1)</p>

9.3.2.1.16 Offset 40h: CORBBASE - CORB Base Address Register

Table 241. 40h: CORBBASE - CORB Base Address Register

Size: 32 bit		Default: 0000_0000h		Power Well: Core
Access		PCI Configuration B:D:F 0:27:0		Offset Start: 40h Offset End: 43h
		Memory Mapped IO BAR: LBAR		Offset:
Bit Range	Default	Access	Acronym	Description
31 :07	0	RW	CORBBASE	CORB Base Address: This field is the address of the Command Output Ring Buffer, allowing the CORB Base Address to be assigned on any 128-B boundary. This register field must not be written when the DMA engine is running or the DMA transfer may be corrupted.
06 :00	0	RO	RSVD	Reserved

9.3.2.1.17 Offset 48h: CORBWP - CORB Write Pointer Register

Table 242. 48h: CORBWP - CORB Write Pointer Register (Sheet 1 of 2)

Size: 16 bit		Default: 0000h		Power Well: Core
Access		PCI Configuration B:D:F 0:27:0		Offset Start: 48h Offset End: 49h
		Memory Mapped IO BAR: LBAR		Offset:
Bit Range	Default	Access	Acronym	Description
15 :08	0	RO	RSVD	Reserved



Table 242. 48h: CORBWP - CORB Write Pointer Register (Sheet 2 of 2)

Size: 16 bit		Default: 0000h		Power Well: Core
Access		PCI Configuration B:D:F 0:27:0		Offset Start: 48h Offset End: 49h
		Memory Mapped IO BAR: LBAR		Offset:
Bit Range	Default	Access	Acronym	Description
07 :00	0	RW	CORBWP	CORB Write Pointer: Software writes the last valid CORB entry offset into this field in Dword granularity. The DMA engine fetches commands from the CORB until the Read Pointer matches the Write Pointer. Supports 256 CORB entries (256 x 4B=1KB). This field may be written while the DMA engine is running.

9.3.2.1.18 Offset 4Ah: CORBRP - CORB Read Pointer Register

Table 243. 4Ah: CORBRP - CORB Read Pointer Register

Size: 16 bit		Default: 0000h		Power Well: Core
Access		PCI Configuration B:D:F 0:27:0		Offset Start: 4Ah Offset End: 4Bh
		Memory Mapped IO BAR: LBAR		Offset:
Bit Range	Default	Access	Acronym	Description
15	0	RW	RSVD	CORB Read Pointer Reset: Software writes a 1 to this bit to reset the CORB Read Pointer to 0 and clear any residual prefetched commands in the CORB hardware buffer within the Intel® HD Audio [®] controller. The hardware will physically update this bit to 1 when the CORB Pointer reset is complete. Software must read a 1 to verify that the reset completed correctly. Software must clear this bit back to 0 and read back the 0 to verify that the clear completed correctly. The CORB DMA engine must be stopped prior to resetting the Read Pointer or else DMA transfer may be corrupted.
14 :08	0	RO	CORBWP	Reserved
07 :00	0	RO		CORB Read Pointer: Software reads this field to determine how many commands it can write to the CORB without over-running. The value read indicates the CORB Read Pointer offset in Dword granularity. The offset entry read from this field has been successfully fetched by the DMA controller and may be over-written by software. Supports 256 CORB entries (256 x 4B=1KB). This field may be read while the DMA engine is running.

9.3.2.1.19 Offset 4Ch: CORBCTL - CORB Control Register

Table 244. 4Ch: CORBCTL - CORB Control Register (Sheet 1 of 2)

Size: 8 bit		Default: 0000h		Power Well: Core
Access		PCI Configuration B:D:F 0:27:0		Offset Start: 4Ch Offset End: 4Ch
		Memory Mapped IO BAR: LBAR		Offset:
Bit Range	Default	Access	Acronym	Description
07 :02	0	RO	RSVD	Reserved

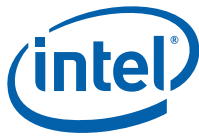

Table 244. 4Ch: CORBCTL - CORB Control Register (Sheet 2 of 2)

Size: 8 bit		Default: 0000h		Power Well: Core
Access		PCI Configuration B:D:F 0:27:0		Offset Start: 4Ch Offset End: 4Ch
		Memory Mapped IO BAR: LBAR		Offset:
Bit Range	Default	Access	Acronym	Description
01	0	RW	CORBRUN	Enable CORB DMA Engine: 0 = DMA Stop 1 = DMA Run After software writes a 0 to this bit, the hardware may not stop immediately. The hardware will physically update the bit to a 0 when the DMA engine is truly stopped. Software must read a 0 from this bit to verify that the DMA is truly stopped.
00	0	RW	CMEIE	CORB Memory Error Interrupt Enable: If this bit is set, the controller will generate an interrupt if the MEI status bit (LBAR + 4Dh: bit 0) is set.

9.3.2.1.20 Offset 4Dh: CORBSTS - CORB Status Register

Table 245. 4Dh: CORBSTS - CORB Status Register

Size: 8 bit		Default: 0000h		Power Well: Core
Access		PCI Configuration B:D:F 0:27:0		Offset Start: 4Dh Offset End: 4Dh
		Memory Mapped IO BAR: LBAR		Offset:
Bit Range	Default	Access	Acronym	Description
07:01	0	RO	RSVD	Reserved
00	0	RW	CMEI	CORB Memory Error Indication: If this status bit is set, the controller has detected an error in the pathway between the controller and memory. This may be an ECC bit error or any other type of detectable data error which renders the command data fetched invalid. Software can clear this bit by writing a 1 to it. However, this type of error leaves the audio subsystem in an unviable state and typically requires a CRST_B.

9.3.2.1.21 Offset 4Eh: CORBSIZE - CORB Size Register

Table 246. 4Eh: CORBSIZE - CORB Size Register

Size: 8 bit		Default: 42h		Power Well: Core
Access		PCI Configuration B:D:F 0:27:0		Offset Start: 4Eh Offset End: 4Eh
		Memory Mapped IO BAR: LBAR		Offset:
Bit Range	Default	Access	Acronym	Description
07:04	0100b	RO	CORBSZCAP	CORB Size Capability: 0100b indicates that the processor only supports a CORB size of 256 CORB entries (1024B).
03:02	0	RO	RSVD	Reserved
01:00	10b	RO	CORBSIZE	CORB Size: Hardwired to 10b which sets the CORB size to 256 entries (1024B).

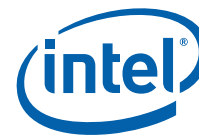

9.3.2.1.22 Offset 50h: RIRBBASE - RIRB Base Address Register

Table 247. 50h: RIRBBASE - RIRB Base Address Register

Size: 32 bit		Default: 0000_0000h		Power Well: Core
Access		PCI Configuration B:D:F 0:27:0		Offset Start: 50h Offset End: 53h
		Memory Mapped IO BAR: LBAR		Offset:
Bit Range	Default	Access	Acronym	Description
31 : 07	0	RW	RIRBBASE	RIRB Base Address: This field is the address of the Response Input Ring Buffer, allowing the RIRB Base Address to be assigned on any 128-B boundary. This register field must not be written when the DMA engine is running or the DMA transfer may be corrupted.
06 : 00	0	RO	RSVD	Reserved

9.3.2.1.23 Offset 58h: RIRBWP - RIRB Write Pointer Register

Table 248. 58h: RIRBWP - RIRB Write Pointer Register

Size: 16 bit		Default: 0000h		Power Well: Core
Access		PCI Configuration B:D:F 0:27:0		Offset Start: 58h Offset End: 59h
		Memory Mapped IO BAR: LBAR		Offset:
Bit Range	Default	Access	Acronym	Description
15	0	WO	RIRBWPST	RIRB Write Pointer Reset: Software writes a 1 to this bit to reset the RIRB Write Pointer to 0. The RIRB DMA engine must be stopped prior to resetting the Write Pointer or else DMA transfer may be corrupted. This bit will always be read as 0.
14 : 08	0	RO	RSVD	Reserved
07 : 00	0	RO	RIRBWP	RIRB Write Pointer: Indicates the last valid RIRB entry written by the DMA controller. Software reads this field to determine how many responses it can read from the RIRB. The value read indicates the RIRB Write Pointer offset in 2 Dword RIRB entry units (since each RIRB entry is 2 Dwords long). Supports up to 256 RIRB entries (256 x 8B=2KB). This field may be read while the DMA engine is running.

9.3.2.1.24 Offset 5Ah: RINTCNT – Response Interrupt Count Register

Table 249. 5Ah: RINTCNT – Response Interrupt Count Register (Sheet 1 of 2)

Size: 16 bit		Default: 0000h		Power Well: Core
Access		PCI Configuration B:D:F 0:27:0		Offset Start: 5Ah Offset End: 5Bh
		Memory Mapped IO BAR: LBAR		Offset:
Bit Range	Default	Access	Acronym	Description
15 : 08	0	RO	RSVD	Reserved

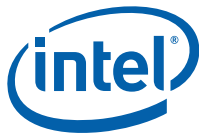

Table 249. 5Ah: RINTCNT – Response Interrupt Count Register (Sheet 2 of 2)

Size: 16 bit		Default: 0000h		Power Well: Core
Access		PCI Configuration B:D:F 0:27:0		Offset Start: 5Ah Offset End: 5Bh
		Memory Mapped IO BAR: LBAR		Offset:
Bit Range	Default	Access	Acronym	Description
07 : 00	00h	RW	RINTCNT	<p>N Response Interrupt Count: 0000_0001b = 1 Response sent to RIRB ... 1111_1111b = 255 Responses sent to RIRB 0000_0000b = 256 Responses sent to RIRB The DMA engine should be stopped when changing this field or else an interrupt may be lost. Note that each Response occupies 2 Dwords in the RIRB. This is compared to the total number of responses that have been returned, as opposed to the number of frames in which there were responses. If more than one codec responds in one frame, then the count is increased by the number of responses received in the frame.</p>

9.3.2.1.25 Offset 5Ch: RIRBCTL - RIRB Control Register

Table 250. 5Ch: RIRBCTL - RIRB Control Register

Size: 8 bit		Default: 00h		Power Well: Core
Access		PCI Configuration B:D:F 0:27:0		Offset Start: 5Ch Offset End: 5Ch
		Memory Mapped IO BAR: LBAR		Offset:
Bit Range	Default	Access	Acronym	Description
07 : 03	0	RO	RSVD	Reserved
02	0	RW	RIRBOIC	Response Overrun Interrupt Control: If this bit is set, the hardware will generate an interrupt when the Response Overrun Interrupt Status bit (LBAR + 5Dh: bit 2) is set.
01	0	RW	RIRBRUN	<p>Enable RIRB DMA Engine: 0 = DMA Stop 1 = DMA Run After software writes a 0 to this bit, the hardware may not stop immediately. The hardware will physically update the bit to a 0 when the DMA engine is truly stopped. Software must read a 0 from this bit to verify that the DMA is truly stopped.</p>
00	0	RW	RINTCTL	<p>Response Interrupt Control: 0 = Disable Interrupt 1 = Generate an interrupt after N number of Responses are sent to the RIRB buffer OR when an empty Response slot is encountered on all HDA_SDI[x] inputs (whichever occurs first). The N counter is reset when the interrupt is generated.</p>

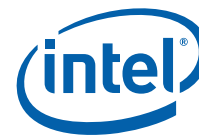

9.3.2.1.26 Offset 5Dh: RIRBSTS - RIRB Status Register

Table 251. 5Dh: RIRBSTS - RIRB Status Register

Size: 8 bit		Default: 00h		Power Well: Core
Access		PCI Configuration B:D:F 0:27:0		Offset Start: 5Dh Offset End: 5Dh
		Memory Mapped IO BAR: LBAR		Offset:
Bit Range	Default	Access	Acronym	Description
07:03	0	RO	RSVD	Reserved
02	0	RWC	RIRBOIS	Response Overrun Interrupt Status: Hardware sets this bit to a 1 when the RIRB DMA engine is not able to write the incoming responses to memory before additional incoming responses overrun the internal FIFO. When the overrun occurs, the hardware will drop the responses which overrun the buffer. An interrupt may be generated if the Response Overrun Interrupt Control bit is set. Note that this status bit is set even if an interrupt is not enabled for this event. Software clears this flag by writing a 1 to this bit.
01	0	RO	RSVD	Reserved
00	0	RWC	RINTFL	Response Interrupt: Hardware sets this bit to a 1 when an interrupt has been generated after N number of Responses are sent to the RIRB buffer OR when an empty Response slot is encountered on all HDA_SDI[x] inputs (whichever occurs first). Note that this status bit is set even if an interrupt is not enabled for this event. Software clears this flag by writing a 1 to this bit.

9.3.2.1.27 Offset 5Eh: RIRBSIZE - RIRB Size Register

Table 252. 5Eh: RIRBSIZE - RIRB Size Register

Size: 8 bit		Default: 42h		Power Well: Core
Access		PCI Configuration B:D:F 0:27:0		Offset Start: 5Eh Offset End: 5Eh
		Memory Mapped IO BAR: LBAR		Offset:
Bit Range	Default	Access	Acronym	Description
07:04	0100b	RO	RIRBSZCAP	RIRB Size Capability: 0100b indicates that the processor only supports a RIRB size of 256 RIRB entries (2048B).
03:02	0	RO	RSVD	Reserved
01:00	10	RO	RIRBSIZE	RIRB Size: Hardwired to 10b which sets the RIRB size to 256 entries (2048B).

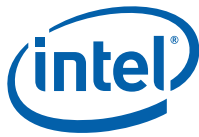

9.3.2.1.28 Offset 60h: IC – Immediate Command Register

Table 253. 60h: IC – Immediate Command Register

Size: 32 bit		Default: 0000_0000h		Power Well: Core
Access		PCI Configuration B:D:F 0:27:0		Offset Start: 60h Offset End: 63h
		Memory Mapped IO BAR: LBAR		Offset:
Bit Range	Default	Access	Acronym	Description
31 :00	0	RW	ICW	Immediate Command Write: The command to be sent to the codec via the Immediate Command mechanism is written to this register. The command stored in this register is sent out over the link during the next available frame after a 1 is written to the ICB bit (LBAR +68h: bit 0).

9.3.2.1.29 Offset 64h: IR – Immediate Response Register

Table 254. 64h: IR – Immediate Response Register

Size: 32 bit		Default: 0000_0000h		Power Well: Core
Access		PCI Configuration B:D:F 0:27:0		Offset Start: 64h Offset End: 67h
		Memory Mapped IO BAR: LBAR		Offset:
Bit Range	Default	Access	Acronym	Description
31 :00	0	RO	IRR	Immediate Response Read: This register contains the response received from a codec resulting from a command sent via the Immediate Command mechanism. If multiple codecs responded in the same frame, there is no guarantee as to which response will be latched. Therefore broadcast-type commands must not be issued via the Immediate Command mechanism.

9.3.2.1.30 Offset 68h: ICS – Immediate Command Status

Table 255. 68h: ICS – Immediate Command Status (Sheet 1 of 2)

Size: 16 bit		Default: 0000h		Power Well: Core
Access		PCI Configuration B:D:F 0:27:0		Offset Start: 68h Offset End: 69h
		Memory Mapped IO BAR: LBAR		Offset:
Bit Range	Default	Access	Acronym	Description
15 :02	0	RO	RSVD	Reserved
01	0	RWC	IRV	Immediate Result Valid: This bit is set to a '1' by hardware when a new response is latched into the IRR register. This is a status flag indicating that software may read the response from the Immediate Response register. Software must clear this bit (by writing a one to it) before issuing a new command so that the software may determine when a new response has arrived.



Table 255. 68h: ICS – Immediate Command Status (Sheet 2 of 2)

Size: 16 bit		Default: 0000h		Power Well: Core
Access		PCI Configuration B:D:F 0:27:0		Offset Start: 68h Offset End: 69h
		Memory Mapped IO BAR: LBAR		Offset:
Bit Range	Default	Access	Acronym	Description
00	0	RW	ICB	Immediate Command Busy: When this bit as read as a 0 it indicates that a new command may be issued using the Immediate Command mechanism. When this bit transitions from a 0 to a 1 (via software writing a 1), the controller issues the command currently stored in the Immediate Command register to the codec over the link. When the corresponding response is latched into the Immediate Response register, the controller hardware sets the IRV flag and clears the ICB bit back to 0. Note that an Immediate Command must not be issued while the CORB/RIRB mechanism is operating, otherwise the responses conflict. This must be enforced by software.

9.3.2.1.31 Offset 70h: DPBASE – DMA Position Base Address Register

Table 256. 70h: DPBASE – DMA Position Base Address Register

Size: 32 bit		Default: 0000_0000h		Power Well: Core
Access		PCI Configuration B:D:F 0:27:0		Offset Start: 70h Offset End: 73h
		Memory Mapped IO BAR: LBAR		Offset:
Bit Range	Default	Access	Acronym	Description
31 :07	0	RW	DPBASE	DMA Position Base Address: This field is the 32 bits of the DMA Position Buffer Base Address. This register field must not be written when any DMA engine is running or the DMA transfer may be corrupted. This same address is used by the Flush Control, and must be programmed with a valid value before the FLCNRTL bit (LBAR + 08h: bit 1) is set.
06 :01	0	RO	RSVD	Reserved
00	0	RW		DMA Position Buffer Enable: When this bit is set to a '1', the controller will write the DMA positions of each of the DMA engines to the buffer in main memory periodically (typically once/frame). Software can use this value to know what data in memory is valid data.

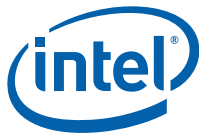

9.3.2.1.32 Offset 80h, A0h, C0h, E0h: ISDOCTL, ISD1CTL, OSD0CTL, OSD1CTL – Input/Output Stream Descriptor [0-1] Control Register

Table 257. 80h, A0h, C0h, E0h: ISDOCTL, ISD1CTL, OSD0CTL, OSD1CTL – Input/Output Stream Descriptor [0-1] Control Register (Sheet 1 of 2)

Size: 24 bit		Default: 04_0000h		Power Well: Core
Access	PCI Configuration		B:D:F 0:27:0	Offset Start: 80h, A0h, C0h, E0h Offset End: 82h, A2h, C2h, E2h
	Memory Mapped IO		BAR: LBAR	Offset:
Bit Range	Default	Access	Acronym	Description
23 : 20	0	RW	STRM	Stream Number: This value reflects the Tag associated with the data being transferred on the link. When data controlled by this descriptor is sent out over the link, it will have this stream number encoded on the HDA_SYNC signal. When an input stream is detected on any of the HDA_SDI[x] signals that match this value, the data samples are loaded into the FIFO associated with this descriptor. Note that while a single HDA_SDI[x] input may contain data from more than one stream number, two different HDA_SDI[x] inputs may not be configured with the same stream number. 0000=Reserved (Indicates Unused) 0001=Stream 1 ... 1110=Stream 14 1111=Stream 15
19	0	RO	DIR	Bidirectional Direction Control: This bit is only meaningful for Bidirectional streams. Therefore this bit is hardwired to 0.
18	1	RO	TP	Traffic Priority: Hardwired to 1 indicating that all streams will use VC1 if it is enabled throughout the PCI Express* registers.
17 : 16	00	RO	STRIPE	Stripe Control: This field is meaningless for input streams. Therefore it is hardwired to 0's.
15 : 05	0	RO	RSVD	Reserved
04	0	RW	DEIE	Descriptor Error Interrupt Enable: 0 = Disable 1 = An interrupt is generated when the Descriptor Error Status (DESE) bit is set.
03	0	RW	FEIE	FIFO Error Interrupt Enable: This bit controls whether the occurrence of a FIFO error (overflow for input or underflow for output) will cause an interrupt or not. If this bit is not set, bit 3 in the Status register will be set, but the interrupt will not occur. Either way, the samples will be dropped.
02	0	RW	IOCE	Interrupt On Completion Enable: This bit controls whether or not an interrupt occurs when a buffer completes with the IOC bit set in its descriptor. If this bit is not set, bit 2 in the Status register will be set, but the interrupt will not occur
01	0	RW	RUN	Stream Run: 0 = The DMA engine associated with this input stream will be disabled. Hardware will report a 0 in this bit when the DMA engine is actually stopped. Software must read a 0 from this bit before modifying related control registers or restarting the DMA engine. 1 = The DMA engine associated with this input stream will be enabled to transfer data from the FIFO to main memory. The SSYNC bit must also be cleared in order for the DMA engine to run. For output streams, the cadence generator is reset whenever the RUN bit is set.

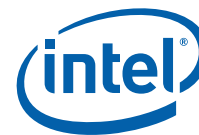
Table 257. 80h, A0h, C0h, E0h: ISDOCTL, ISD1CTL, OSDOCTL, OSD1CTL – Input/Output Stream Descriptor [0-1] Control Register (Sheet 2 of 2)

Size: 24 bit		Default: 04_0000h		Power Well: Core
Access		PCI Configuration B:D:F 0:27:0		Offset Start: 80h, A0h, C0h, E0h Offset End: 82h, A2h, C2h, E2h
		Memory Mapped IO BAR: LBAR		Offset:
Bit Range	Default	Access	Acronym	Description
00	0	RW	SRST	Stream Reset: 0 = Writing a 0 causes the corresponding stream to exit reset. When the stream hardware is ready to begin operation, it will report a 0 in this bit. Software must read a 0 from this bit before accessing any of the stream registers. 1 = Writing a 1 causes the corresponding stream to be reset. The Stream Descriptor registers (except the SRST bit itself) and FIFO's for the corresponding stream are reset. After the stream hardware has completed sequencing into the reset state, it will report a 1 in this bit. Software must read a 1 from this bit to verify that the stream is in reset. The RUN bit must be cleared before SRST is asserted.

9.3.2.1.33 Offset 83h, A3h, C3h, E3h: ISD0STS, ISD1STS, OSD0STS, OSD1STS – Input/Output Stream Descriptor [0-1] Status Register
Table 258. 83h, A3h, C3h, E3h: ISD0STS, ISD1STS, OSD0STS, OSD1STS – Input/Output Stream Descriptor [0-1] Status Register (Sheet 1 of 2)

Size: 8 bit		Default: 00h		Power Well: Core
Access		PCI Configuration B:D:F 0:27:0		Offset Start: 83h, A3h, C3h, E3h Offset End: 83h, A3h, C3h, E3h
		Memory Mapped IO BAR: LBAR		Offset:
Bit Range	Default	Access	Acronym	Description
07:06	0	RW	RO	Reserved
05	0	RO	RO	FIFO Ready: For output streams, the Intel® High Definition Audio ^β controller hardware will set this bit to a 1 while the output DMA FIFO contains enough data to maintain the stream on then link. This bit defaults to 0 on reset because the FIFO is cleared on a reset. For input streams, the Intel® High Definition Audio ^β controller hardware will set this bit to 1 when a valid descriptor is loaded and the engine is ready for the RUN bit to be set.
04	0	RO	RWC	Descriptor Error: When set, this bit Indicates that a serious error occurred during the fetch of a descriptor. This could be a result of a Master Abort, a Parity or ECC error on the bus, or any other error which renders the current Buffer Descriptor or Buffer Descriptor List useless. This error is treated as a fatal stream error, as the stream cannot continue running. The RUN bit will be cleared and the stream will stop. Software may attempt to restart the stream engine after addressing the cause of the error and writing a '1' to this bit to clear it.
03	0	RO	RWC	FIFO Error: This bit is set when a FIFO error occurs. This bit is set even if an interrupt is not enabled. For an input stream, this indicates a FIFO overrun occurring while the RUN bit is set. When this happens, the FIFO pointers don't increment and the incoming data is not written into the FIFO, thereby being lost. For an output stream, this indicates a FIFO under run when there are still buffers to send. The hardware should not transmit anything on the link for the associated stream if there is not valid data to send.



Table 258. 83h, A3h, C3h, E3h: ISD0STS, ISD1STS, OSD0STS, OSD1STS – Input/Output Stream Descriptor [0-1] Status Register (Sheet 2 of 2)

Size: 8 bit		Default: 00h		Power Well: Core
Access		PCI Configuration B:D:F 0:27:0		Offset Start: 83h, A3h, C3h, E3h Offset End: 83h, A3h, C3h, E3h
		Memory Mapped IO BAR: LBAR		Offset:
Bit Range	Default	Access	Acronym	Description
02	0	RO	RWC	Buffer Completion Interrupt Status: This bit is set to 1 by the hardware after the last sample of a buffer has been processed. AND if the Interrupt on Completion (IOC) bit is set in the command byte of the buffer descriptor. It remains active until software clears it by writing a 1 to this bit position.
01 :00	0	RW	RO	Reserved

9.3.2.1.34 Offset 84h, A4h, C4h, E4h: ISD0LPIB, ISD1LPIB, OSD0LPIB, OSD1LPIB – Input/Output Stream Descriptor [0-1] Link Position in Buffer Register

Table 259. 84h, A4h, C4h, E4h: ISD0LPIB, ISD1LPIB, OSD0LPIB, OSD1LPIB – Input/Output Stream Descriptor [0-1] Link Position in Buffer Register

Size: 32 bit		Default: 0000_0000h		Power Well: Core
Access		PCI Configuration B:D:F 0:27:0		Offset Start: 84h, A4h, C4h, E4h Offset End: 87h, A7h, C7h, E7h
		Memory Mapped IO BAR: LBAR		Offset:
Bit Range	Default	Access	Acronym	Description
31 :00	0	RO	LPIB	Link Position in Buffer: Indicates the number of bytes that have been received off the link. This register will count from 0 to the value in the Cyclic Buffer Length register and then wrap to 0.

9.3.2.1.35 Offset 88h, A8h, C8h, E8h: ISD0CBL, ISD1CBL, OSD0CBL, OSD1CBL– Input/Output Stream Descriptor [0-1] Cyclic Buffer Length Register

Table 260. 88h, A8h, C8h, E8h: ISD0CBL, ISD1CBL, OSD0CBL, OSD1CBL– Input/Output Stream Descriptor [0-1] Cyclic Buffer Length Register

Size: 32 bit		Default: 0000_0000h		Power Well: Core
Access		PCI Configuration B:D:F 0:27:0		Offset Start: 88h, A8h, C8h, E8h Offset End: 8Bh, ABh, CBh, EBh
		Memory Mapped IO BAR: LBAR		Offset:
Bit Range	Default	Access	Acronym	Description
31 :00	0	RW	CBL	Length: Indicates the number of bytes in the complete cyclic buffer. CBL must represent an integer number of samples. Link Position in Buffer (LPIB) will be reset when it reaches this value. Software may only write to this register after Global Reset, Controller Reset, or Stream Reset has occurred. This value should only be modified when the RUN bit is '0'. Once the RUN bit has been set to enable the engine, software must not write to this register until after the next reset is asserted, or transfers may be corrupted.

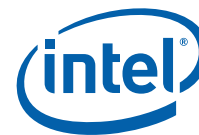

9.3.2.1.36 Offset 8Ch, ACh, CCh, ECh: ISD0LVI, ISD1LVI, OSD0LVI, OSD1LVI—Input/Output Stream Descriptor [0-1] Last Valid Index Register

Table 261. 8Ch, ACh, CCh, ECh: ISD0LVI, ISD1LVI, OSD0LVI, OSD1LVI—Input/Output Stream Descriptor [0-1] Last Valid Index Register

Size: 16 bit		Default: 0000h		Power Well: Core
Access		PCI Configuration B:D:F 0:27:0		Offset Start: 8Ch, ACh CCh, ECh Offset End: 8Dh, ADh CDh, EDh
		Memory Mapped IO BAR: LBAR		Offset:
Bit Range	Default	Access	Acronym	Description
15 :08	0	RO	RSVD	Reserved
07 :00	00h	RW	LVI	Last Valid Index: The value written to this register indicates the index for the last valid Buffer Descriptor in the BDL. After the controller has processed this descriptor, it will wrap back to the first descriptor in the list and continue processing. LVI must be at least 1; i.e., there must be at least two valid entries in the buffer descriptor list before DMA operations can begin. This value should only be modified when the RUN bit is '0'

9.3.2.1.37 Offset 8Eh, AEh, CEh, EEh: ISD0FIFOW, ISD1FIFOW, OSD0FIFOW, OSD1FIFOW—Input/Output Stream Descriptor [0-1] FIFO Watermark Register

Table 262. 8Eh, AEh, CEh, EEh: ISD0FIFOW, ISD1FIFOW, OSD0FIFOW, OSD1FIFOW—Input/Output Stream Descriptor [0-1] FIFO Watermark Register

Size: 16 bit		Default: 0004h		Power Well: Core
Access		PCI Configuration B:D:F 0:27:0		Offset Start: 8Eh, AEh, CEh, EEh Offset End: 8Fh, AFh, CFh, EFh
		Memory Mapped IO BAR: LBAR		Offset:
Bit Range	Default	Access	Acronym	Description
15 :03	0	RO	RSVD	Reserved
02 :00	100b	RW	FIFOW	FIFO Watermark: Indicates the minimum number of bytes accumulated/free in the FIFO before the controller will start a fetch/eviction of data. 010 8B Supported 011 16B Supported 100 32B Supported (Default) other Unsupported Note: When the bit field is programmed to an unsupported size, the hardware sets itself to the default value. Software must read the bit field to test if the value is supported after setting the bit field.

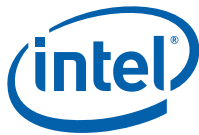

9.3.2.1.38 Offset 90h, B0h: ISD0FIFOS, ISD1FIFOS – Input Stream Descriptor [0-1] FIFO Size Register

Table 263. 90h, B0h: ISD0FIFOS, ISD1FIFOS – Input Stream Descriptor [0-1] FIFO Size Register

Size: 16 bit		Default: 0077h		Power Well: Core														
Access		PCI Configuration B:D:F 0:27:0		Offset Start: 90h, B0h Offset End: 91h, B1h														
		Memory Mapped IO BAR: LBAR		Offset:														
Bit Range	Default	Access	Acronym	Description														
15 :08	0	RO	RSVD	Reserved														
07 :00	77h	RO	FIFOS	<p>FIFO Size: Indicates the maximum number of bytes that could be fetched by the controller at one time. This is the maximum number of bytes that may have been DMA'd into memory but not yet transmitted on the link, and is also the maximum possible value that the PICB count will increase by at one time.</p> <p>The value in this field is different for input and output streams. It is also dependent on the Bits per Sample setting for the corresponding stream. Following table shows the values read/written from/to this register for input and output streams, and for non-padded and padded bit formats: For Output Stream, FIFOS is a RW field. The default after reset is BFh:</p> <table border="1"> <thead> <tr> <th>Value¹</th> <th>Output Streams</th> </tr> </thead> <tbody> <tr> <td>0Fh = 16B</td> <td>8, 16, 20, 24 or 32 bit Output Streams</td> </tr> <tr> <td>1Fh = 32B</td> <td>8, 16, 20, 24 or 32 bit Output Streams</td> </tr> <tr> <td>3Fh = 64B</td> <td>8, 16, 20, 24 or 32 bit Output Streams</td> </tr> <tr> <td>7Fh = 128B</td> <td>8, 16, 20, 24 or 32 bit Output Streams</td> </tr> <tr> <td>BFh = 192B</td> <td>8, 16 or 32 bit Output Streams</td> </tr> <tr> <td>FFh = 256B</td> <td>20, 24 bit Output Streams</td> </tr> </tbody> </table> <p>Notes:</p> <ol style="list-style-type: none"> All other values are Not Supported. When the output stream is programmed to an unsupported size, the hardware sets itself to the default value (BFh) Software must read the bit field to test if the value is supported after setting the bit field. <p>For Input Stream, FIFOS is a RO field with the following value: 8, 16, 32-bit Input Streams: 120B = 77h 20, 24-bit Input Streams: 160B = 9Fh</p> <p>Note the default value is different for input and output streams, and reflects the default state of the BITS fields (in Stream Descriptor Format registers) for the corresponding stream.</p>	Value ¹	Output Streams	0Fh = 16B	8, 16, 20, 24 or 32 bit Output Streams	1Fh = 32B	8, 16, 20, 24 or 32 bit Output Streams	3Fh = 64B	8, 16, 20, 24 or 32 bit Output Streams	7Fh = 128B	8, 16, 20, 24 or 32 bit Output Streams	BFh = 192B	8, 16 or 32 bit Output Streams	FFh = 256B	20, 24 bit Output Streams
Value ¹	Output Streams																	
0Fh = 16B	8, 16, 20, 24 or 32 bit Output Streams																	
1Fh = 32B	8, 16, 20, 24 or 32 bit Output Streams																	
3Fh = 64B	8, 16, 20, 24 or 32 bit Output Streams																	
7Fh = 128B	8, 16, 20, 24 or 32 bit Output Streams																	
BFh = 192B	8, 16 or 32 bit Output Streams																	
FFh = 256B	20, 24 bit Output Streams																	

9.3.2.1.39 Offset D0h, F0h: OSD0FIFOS, OSD1FIFOS – Output Stream Descriptor [0-1] FIFO Size Register

Table 264. D0h, F0h: OSD0FIFOS, OSD1FIFOS – Output Stream Descriptor [0-1] FIFO Size Register (Sheet 1 of 2)

Size: 16 bit		Default: 00BFh		Power Well: Core
Access		PCI Configuration B:D:F 0:27:0		Offset Start: D0h, F0h Offset End: D1h, F1h
		Memory Mapped IO BAR: LBAR		Offset:
Bit Range	Default	Access	Acronym	Description
15 :08	0	RO	RSVD	Reserved

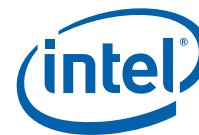

Table 264. D0h, F0h: OSD0FIFOS, OSD1FIFOS – Output Stream Descriptor [0-1] FIFO Size Register (Sheet 2 of 2)

Size: 16 bit		Default: 00BFh		Power Well: Core														
Access		PCI Configuration B:D:F 0:27:0		Offset Start: D0h, F0h Offset End: D1h, F1h														
		Memory Mapped IO BAR: LBAR		Offset:														
Bit Range	Default	Access	Acronym	Description														
07 : 00	BFh	RW	FIFOS	<p>FIFO Size: Indicates the maximum number of bytes that could be fetched by the controller at one time. This is the maximum number of bytes that may have been DMA'd into memory but not yet transmitted on the link, and is also the maximum possible value that the PICB count will increase by at one time.</p> <p>The value in this field is different for input and output streams. It is also dependent on the Bits per Sample setting for the corresponding stream. Following table shows the values read/written from/to this register for input and output streams, and for non-padded and padded bit formats: For Output Stream, FIFOS is a RW field. The default after reset is BFh:</p> <table border="1"> <thead> <tr> <th>Value¹</th> <th>Output Streams</th> </tr> </thead> <tbody> <tr> <td>0Fh = 16B</td> <td>8, 16, 20, 24 or 32 bit Output Streams</td> </tr> <tr> <td>1Fh = 32B</td> <td>8, 16, 20, 24 or 32 bit Output Streams</td> </tr> <tr> <td>3Fh = 64B</td> <td>8, 16, 20, 24 or 32 bit Output Streams</td> </tr> <tr> <td>7Fh = 128B</td> <td>8, 16, 20, 24 or 32 bit Output Streams</td> </tr> <tr> <td>BFh = 192B</td> <td>8, 16 or 32 bit Output Streams</td> </tr> <tr> <td>FFh = 256B</td> <td>20, 24 bit Output Streams</td> </tr> </tbody> </table> <p>Notes:</p> <ol style="list-style-type: none"> All other values are Not Supported. When the output stream is programmed to an unsupported size, the hardware sets itself to the default value (BFh) Software must read the bit field to test if the value is supported after setting the bit field. <p>For Input Stream, FIFOS is a RO field with the following value: 8, 16, 32-bit Input Streams: 120B = 77h 20, 24-bit Input Streams: 160B = 9Fh Note the default value is different for input and output streams, and reflects the default state of the BITS fields (in Stream Descriptor Format registers) for the corresponding stream.</p>	Value ¹	Output Streams	0Fh = 16B	8, 16, 20, 24 or 32 bit Output Streams	1Fh = 32B	8, 16, 20, 24 or 32 bit Output Streams	3Fh = 64B	8, 16, 20, 24 or 32 bit Output Streams	7Fh = 128B	8, 16, 20, 24 or 32 bit Output Streams	BFh = 192B	8, 16 or 32 bit Output Streams	FFh = 256B	20, 24 bit Output Streams
Value ¹	Output Streams																	
0Fh = 16B	8, 16, 20, 24 or 32 bit Output Streams																	
1Fh = 32B	8, 16, 20, 24 or 32 bit Output Streams																	
3Fh = 64B	8, 16, 20, 24 or 32 bit Output Streams																	
7Fh = 128B	8, 16, 20, 24 or 32 bit Output Streams																	
BFh = 192B	8, 16 or 32 bit Output Streams																	
FFh = 256B	20, 24 bit Output Streams																	

9.3.2.1.40 Offset 92h, B2h, D2h, F2h: ISD0FMT, ISD1FMT, OSD0FMT, OSD1FMT – Input/Output Stream Descriptor [0-1] Format Register

Table 265. 92h, B2h, D2h, F2h: ISD0FMT, ISD1FMT, OSD0FMT, OSD1FMT – Input/Output Stream Descriptor [0-1] Format Register (Sheet 1 of 2)

Size: 16 bit		Default: 0000h		Power Well: Core
Access		PCI Configuration B:D:F 0:27:0		Offset Start: 92h, B2h, D2h, F2h Offset End: 93h, B3h, D3h, F3h
		Memory Mapped IO BAR: LBAR		Offset:
Bit Range	Default	Access	Acronym	Description
15	0	RO	RSVD	Reserved
14	0	RW	BASE	Sample Base Rate: 0=48 kHz 1=44.1 kHz



Table 265. 92h, B2h, D2h, F2h: ISD0FMT, ISD1FMT, OSD0FMT, OSD1FMT – Input/Output Stream Descriptor [0-1] Format Register (Sheet 2 of 2)

Size: 16 bit		Default: 0000h		Power Well: Core
Access		PCI Configuration	B:D:F 0:27:0	Offset Start: 92h, B2h, D2h, F2h Offset End: 93h, B3h, D3h, F3h
		Memory Mapped IO	BAR: LBAR	Offset:
Bit Range	Default	Access	Acronym	Description
13 : 11	000b	RW	MULT	Sample Base Rate Multiple: 000=48 kHz/44.1 kHz or less 001=x2 (96 kHz, 88.2 kHz, 32 kHz) 010=x3 (144 kHz) 011=x4 (192 kHz, 176.4 kHz) 100-111=Reserved
10 : 08	000b	RW	DIV	Sample Base Rate Divisor: 000=Divide by 1 (48 kHz, 44.1 kHz) 001=Divide by 2 (24 kHz, 22.05 kHz) 010=Divide by 3 (16 kHz, 32 kHz) 011=Divide by 4 (11.025 kHz) 100=Divide by 5 (9.6 kHz) 101=Divide by 6 (8 kHz) 110=Divide by 7 111=Divide by 8 (6 kHz)
07	0	RO	RSVD	Reserved
06 : 04	000b	RW	BITS	Bits per Sample: 000=8 bits. The data will be packed in memory in 8-bit containers on 16-bit boundaries 001=16 bits. The data will be packed in memory in 16-bit containers on 16-bit boundaries 010=20 bits. The data will be packed in memory in 32-bit containers on 32-bit boundaries 011=24 bits. The data will be packed in memory in 32-bit containers on 32-bit boundaries 100=32 bits. The data will be packed in memory in 32-bit containers on 32-bit boundaries Others =Reserved
03 : 00	0000	RW	CHAN	Number of Channels: Number of channels in each frame of the stream: 0000=1 0001=2 ... 1111=16

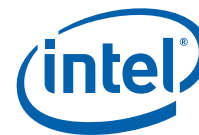

9.3.2.1.41 Offset 98h, B8h, D8h, F8h: ISD0BDPL, ISD1BDPL, OSD0BDPL, OSD1BDPL – Input/Output Stream Descriptor [0-1] Buffer Descriptor List Pointer Register

Table 266. 98h, B8h, D8h, F8h: ISD0BDPL, ISD1BDPL, OSD0BDPL, OSD1BDPL – Input/Output Stream Descriptor [0-1] Buffer Descriptor List Pointer Register

Size: 32 bit		Default: 0000_0000h		Power Well: Core
Access		PCI Configuration B:D:F 0:27:0		Offset Start: 98h, B8h, D8h, F8h Offset End: 9Bh, BBh, DBh, FBh
		Memory Mapped IO BAR: LBAR		Offset:
Bit Range	Default	Access	Acronym	Description
31 : 07	0	RW	BDLBASE	Buffer Descriptor List Base Address: Lower address of the Buffer Descriptor List. This value should only be modified when the RUN bit is '0' or DMA transfers may be corrupted.
06 : 01	0	RO	RSVD	Reserved
00	0	RW/WO	PROT	Protect: When this bit is set to 1, bits [31:7, 0] of this register are Write Only and will return 0 when read. When this bit is cleared to 0, bits [31:7, 0] are RW. This bit can only be changed when all four bytes of this register are written in a single write operation. If less than four bytes are written this bit retains its previous value.

9.3.2.1.42 Offset 1000h: EM1 – Extended Mode 1 Register

Table 267. 1000h: EM1 – Extended Mode 1 Register (Sheet 1 of 2)

Size: 32 bit		Default: 0000_0000h		Power Well: Core
Access		PCI Configuration B:D:F 0:27:0		Offset Start: 1000h Offset End: 1003h
		Memory Mapped IO BAR:		Offset:
Bit Range	Default	Access	Acronym	Description
31 : 24	0	RO	RSVD	Reserved
28	0	RW	LPBKEN	Loopback Enable: When set, output data is rerouted to the input. Each input has its own loopback enable.
27 : 26	0	RW	FREECNTREQ	Free Count Request: This field determines the clock in which freecnt will be requested from the XFR layer. BIOS or software must set FREECNTREQ to "11" Any other selection will cause RIRB failures.
25	0	RW	PSEL	Phase Select: Sets the input data sample point within phyclk. 1 = Phase C, 0 = Phase D
24	1	RW	128_4K	Boundary Break: Sets the break boundary for reads. 0 = 4KB 1 = 128B
23 : 21	000	RW	CORBPACE	CORB Pace: Determines the rate at which CORB commands are issued on the link. 000 = Every Frame 001 = Every 2 Frames 111 = Every 8 Frames
20	0	RW	FRS	FIFO Ready Select: When cleared, SDS.FRDY is asserted when there are 2 or more packets available in the FIFO. When set, SDS.FRDY is asserted when there are one or more packets available in the FIFO.



Table 267. 1000h: EM1 – Extended Mode 1 Register (Sheet 2 of 2)

Size: 32 bit		Default: 0000_0000h		Power Well: Core
Access		PCI Configuration B:D:F 0:27:0		Offset Start: 1000h Offset End: 1003h
		Memory Mapped IO BAR:		Offset:
Bit Range	Default	Access	Acronym	Description
19 : 15	0	RO	RSVD	Reserved
14	0	RW	48k_EN	48 KHz Enable: When set, the processor adds one extra bitclk to every twelfth frame. When cleared, it will use the normal functionality and send 500 bitclks per frame.
13	0	RW	DETS	Dock Enable Signal Transition Select: When set, HDA_DOCK_EN_B transitions off the falling edge of BCLK (phase C). When cleared, HDA_DOCK_EN_B transitions 1/4 BCLK after the falling edge of BCLK (phase D).
12 : 11	0	RW	RSVD	Reserved
10 : 06	0	RO	RSVD	Reserved
05 : 04	0	WO	IRCR	Input Repeat Count Resets: Software writes a 1 to clear the respective Repeat Count to 00h. Reads from these bits return 0. Bit 5 = Input Stream 1 Repeat Count Reset Bit 4 = Input Stream 0 Repeat Count Reset
03 : 02	0	RO	RSVD	Reserved
01 : 00	0	WO	ORCR	Output Repeat Count Resets: Software writes a 1 to clear the respective Repeat Count to 00h. Reads from these bits return 0. Bit 1 = Output Stream 1 Repeat Count Reset Bit 0 = Output Stream 0 Repeat Count Reset

9.3.2.1.43 Offset 1004h: INRC – Input Stream Repeat Count Register

Table 268. 1004h: INRC – Input Stream Repeat Count Register

Size: 32 bit		Default: 0000_0000h		Power Well: Core
Access		PCI Configuration B:D:F 0:27:0		Offset Start: 1004h Offset End: 1007h
		Memory Mapped IO BAR:		Offset:
Bit Range	Default	Access	Acronym	Description
31 : 16	00h	RO	RSVD	Reserved
15 : 08	00h	RO	IN1RC	Input Stream 1 Repeat Count: This field reports the number of times a buffer descriptor list has been repeated.
07 : 00	00h	RO	IN0RC	Input Stream 0 Repeat Count: This field reports the number of times a buffer descriptor list has been repeated.



9.3.2.1.44 Offset 1008h: OUTRC – Output Stream Repeat Count Register

Table 269. 1008h: OUTRC – Output Stream Repeat Count Register

Size: 32 bit		Default: 0000_0000h		Power Well: Core
Access		PCI Configuration B:D:F 0:27:0		Offset Start: 1008h Offset End: 100Bh
		Memory Mapped IO BAR:		Offset:
Bit Range	Default	Access	Acronym	Description
31 : 16	00h	RO	RSVD	Reserved
15 : 08	00h	RO	OUT1RC	Output Stream 1 Repeat Count: This field reports the number of times a buffer descriptor list has been repeated.
07 : 00	00h	RO	OUT0RC	Output Stream 0 Repeat Count: This field reports the number of times a buffer descriptor list has been repeated.

9.3.2.1.45 Offset 100Ch: FIFOTRK – FIFO Tracking Register

Table 270. 100Ch: FIFOTRK – FIFO Tracking Register

Size: 32 bit		Default: 000F_F800h		Power Well: Core
Access		PCI Configuration B:D:F 0:27:0		Offset Start: 100Ch Offset End: 100Fh
		Memory Mapped IO BAR:		Offset:
Bit Range	Default	Access	Acronym	Description
31 : 20	0	RO	RSVD	Reserved
19 : 11	1FFh	RO	MSTS	Minimum Status: Tracks the minimum FIFO free count for inbound engines, and the minimum avail count for outbound engines when the EN is set and the R is de-asserted. The FIFO of the DMA selected by the DMASEL will be tracked.
10 : 05	0h	RO	EC	Error Count; Increment each time a FIFO error occurs in the FIFO which the DMA select is pointing to when the enable bit is set and R is de-asserted. When the EC reaches the max count of 1FFh (63), the count saturates and hold the max count until it is reset.
04 : 02	0h	RW	SEL	Select: The MSTS and EC track the FIFO for the DMA select by this register. The mapping is as follows: 000: Output DMA 0 001: Output DMA 1 010: Reserved 011: Reserved 100: Input DMA 0 101: Input DMA 1 110: Reserved 111: Reserved
01	0	RW	EN	Enable: When set to 1, the MSTS and the EC fields in this register track the minimum FIFO status or error count. When set to 0, the MSTS and the EC fields hold its previous value.
00	0	RW	R	Reset: When set to 1, the MSTS and the EC are reset to their default value.

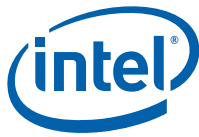

9.3.2.1.46 Offset 1010h, 1014h, 1020h, 1024h: I0DPIB, I1DPIB, O0DPIB, O1DPIB – Input/Output Stream Descriptor [0-1] DMA Position in Buffer Register

Table 271. 1010h, 1014h, 1020h, 1024h: I0DPIB, I1DPIB, O0DPIB, O1DPIB – Input/Output Stream Descriptor [0-1] DMA Position in Buffer Register

Size: 32 bit		Default: 0000_0000h		Power Well: Core
Access		PCI Configuration B:D:F 0:27:0		Offset Start: 1010h, 1014h, 1020h, 1024h Offset End: 1013h, 1017h, 1023h, 1027h
		Memory Mapped IO BAR:		Offset:
Bit Range	Default	Access	Acronym	Description
31 : 00	00h	RO	POS	Position: Indicates the number of bytes "processed" by the DMA engine from the beginning of the BDL. For output streams, it is incremented when data is loaded into the FIFO.

9.3.2.1.47 Offset 1030h: EM2 – Extended Mode 2 Register

Table 272. 1030h: EM2 – Extended Mode 2 Register

Size: 32 bit		Default: 0000_0000h		Power Well: Core
Access		PCI Configuration B:D:F 0:27:0		Offset Start: 1030h Offset End: 1033h
		Memory Mapped IO BAR:		Offset:
Bit Range	Default	Access	Acronym	Description
31 : 09	0	RO	RSVD	Reserved
08	0	RW	CORBRPDIS	CORB Reset Pointer Change Disable: When this bit is 0 the CORB Reset Pointer Reset works as described. When this bit is set to 1 the CORB FIFO is not reset and the CORB Reset Pointer Reset bit is Write Only and always read as 0.
07 : 00	0	RO	RSVD	Reserved

9.3.2.1.48 Offset 2030h: WLCLKA – Wall Clock Alias Register

Table 273. 2030h: WLCLKA – Wall Clock Alias Register

Size: 32 bit		Default: 0000_0000h		Power Well: Core
Access		PCI Configuration B:D:F 0:27:0		Offset Start: 2030h Offset End: 2033h
		Memory Mapped IO BAR:		Offset:
Bit Range	Default	Access	Acronym	Description
31 : 00	0	RO	CounterA	Wall Clock Counter Alias: This is an alias of the WALCK register. 32 bit counter that is incremented on each link Bit Clock period and rolls over from FFFF_FFFFh to 0000_0000h. This counter will roll over to zero with a period of approximately 179 seconds. This counter is enabled while the Bit Clock bit is set to 1. Software uses this counter to synchronize between multiple controllers. Will be reset on controller reset.



9.3.2.1.49 Offset 2084h, 20A4h, 2104h, 2124h: ISD0LPIBA, ISD1LPIBA, OSD0LPIBA, OSD1LPIBA – Input/Output Stream Descriptor [0-1] Link Position in Buffer Alias Register

Table 274. 2084h, 20A4h, 2104h, 2124h: ISD0LPIBA, ISD1LPIBA, OSD0LPIBA, OSD1LPIBA – Input/Output Stream Descriptor [0-1] Link Position in Buffer Alias Register

Size: 32 bit		Default: 0000_0000h		Power Well: Core
Access	PCI Configuration		B:D:F 0:27:0	Offset Start: 2084h, 20A4h, 2104h, 2124h Offset End: 2087h, 20A7h, 2107h, 2127h
	Memory Mapped IO		BAR:	Offset:
Bit Range	Default	Access	Acronym	Description
31 :00	0	RO	POS	Position: This is an alias of the corresponding LPIB register. Indicates the number of bytes that have been received off the link. This register will count from 0 to the value in the Cyclic Buffer Length register and then wraps.

§ §

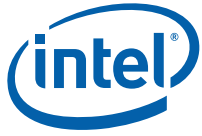



10.0 LPC Interface (D31:F0)

10.1 Functional Overview

The LPC controller implements a low pin count interface that supports the LPC 1.1 specification:

- LSMI_B can be connected to any of the SMI capable GPIO signals.
- The EC's PME_B should connect it to GPE_B.
- The LPC controller's SUS_STAT_B signal is connected directly to the LPCPD_B signal.

The LPC controller does not implement DMA or bus mastering cycles.

The LPC bridge function resides in PCI Device 31:Function 0. This function contains many other functional units, such as DMA and Interrupt controllers, Timers, Power Management, System Management, GPIO, RTC, and LPC Configuration Registers. This section contains the PCI configuration registers for the primary LPC interface. Power Management details are found in a separate chapter, and other ACPI functions (RTC, SMBus, GPIO, Interrupt controllers, Timers, etc.) can be found in the ACPI chapter.

10.1.1 Memory Cycle Notes

For cycles below 16M, the LPC Controller will perform standard LPC memory cycles. For cycles targeting firmware, firmware memory cycles are used. Only 8-bit transfers are performed. If a larger transfer appears, the LPC controller will break it into multiple 8-bit transfers until the request is satisfied.

If the cycle is not claimed by any peripheral (and subsequently aborted), the LPC Controller will return a value of all 1's to the Intel® Atom™ Processor E6xx Series.

10.1.2 Intel® Trusted Platform Module[®] 1.2 Support

The LPC interface supports accessing Intel® Trusted Platform Module[®] (Intel® TPM[®]) 1.2 devices by LPC Intel® TPM[®] START encoding. Memory addresses within the range FED40000h to FED4BFFFh will be accepted by the LPC bridge and sent on LPC as Intel® TPM[®] special cycles. No additional checking of the memory cycle is performed.

10.1.3 FWH Cycle Notes

If the LPC controller receives any SYNC returned from the device other than short wait (0101), long wait (0110), or ready (0000) when running a FWH cycle, indeterminate results may occur. A FWH device is not allowed to assert an Error SYNC. The usage of FWH will not be validated or supported.

10.1.4 LPC Output Clocks

The processor provides three output clocks to drive external LPC devices that may require a PCI-like clock (33 MHz). The LPC output clocks operate at 1/4th the frequency of H_CLKIN[P/N].

LPC_CLKOUT0 is the first clock to be used in the system, configuring its drive strength is done by a strapping option on the GPIO4 pin. The buffer strengths of LPC_CLKOUT1 and LPC_CLKOUT2 default to 2-loads per clock and can be reprogrammed through LPC configuration space.

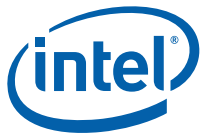

Note: By default, the LPC clocks are only active when LPC bus transfers occur. Because of this behavior, LPC clocks must be routed directly to the bus devices; they cannot go through a clock buffer or other circuit that could delay the signal going to the end device.

10.2 PCI Configuration Registers

Note: Address locations that are not shown should be treated as Reserved.

Table 275. LPC Interface PCI Register Address Map

Offset	Mnemonic	Register Name	Default	Type
00h-03h	ID	Identifiers	81868086h	RO
04h-05h	CMD	Device Command	0003h	RO
06h-07h	STS	Device Status	0000h	RO
08h	RID	Revision Identification	01h (for B-0 stepping) 02h (for B-1 stepping)	RO
09h-0Bh	CC	Class Codes	060100h	RO
0Eh	HDTYPE	Header Type	80h	RO
2Ch-2Fh	SS	Subsystem Identifiers	00000000h	R/WO
40h-43h	SMBA	SMBus Base Address	00000000h	RO, R/W
44h-47h	GBA	GPIO Base Address	00000000h	R/W, RO
48h-4Bh	PM1BLK	PM1_BLK Base Address	00000000h	RO/ R/W
4Ch-4Fh	GPE0BLK	GPE0_BLK Base Address	00000000h	RO, R/W
54h-57h	LPCS	LPC Clock Strength Control	See description	RO, R/W
58h-5Bh	ACTL	ACPI Control	00000003h	RO, R/W
5Ch-5Fh	MC	Miscellaneous Control	00000000h	RO, R/W
60h-67h	PxRC	PIRQ[A-H] Routing Control	80h	RO, R/W
68h-6Bhh	SCNT	Serial IRQ Control	00h	R/W, RO
84h-87h	WDTBA	WDT Base Address	00000000h	R/W, RO
D0h-D3h	FS	FWH ID Select	00112233h	RO, R/W
D4h-D7h	BDE	BIOS Decode Enable	FF000000h	RO, R/W
D8h-DBh	BC	BIOS Control	00000100h	RO, R/W
F0h-F3h	RCBA	Root Complex Base Address	00000000h	R/W, RO

10.2.1 ID—Identifiers

Table 276. Offset 00h: ID – Identifiers (Sheet 1 of 2)

Size: 32 bit		Default: 81868086h		Power Well:
Access		PCI Configuration B:D:F X:31:0		Offset Start: 00h Offset End: 03h
Bit Range	Default	Access	Acronym	Description
31 : 16	8186h	RO	DID	Device Identification: PCI device ID for LPC



Table 276. Offset 00h: ID – Identifiers (Sheet 2 of 2)

Size: 32 bit		Default: 81868086h		Power Well:
Access		PCI Configuration B:D:F X:31:0		Offset Start: 00h Offset End: 03h
Bit Range	Default	Access	Acronym	Description
15 : 00	8086h	RO	VID	Vendor Identification: This is a 16-bit value assigned to Intel.

10.2.2 CMD—Device Command Register

Table 277. Offset 04h: CMD – Device Command

Size: 16 bit		Default: 0003h		Power Well:
Access		PCI Configuration B:D:F X:31:0		Offset Start: 04h Offset End: 05h
Bit Range	Default	Access	Acronym	Description
15 : 02	0	RO	RSVD	Reserved
01	1	RO	MSE	Memory Space Enable: Memory space cannot be disabled on LPC.

10.2.3 STS—Device Status Register

Table 278. Offset 06h: STS – Device Status

Size: 16 bit		Default: 0000h		Power Well:
Access		PCI Configuration B:D:F X:31:0		Offset Start: 06h Offset End: 07h
Bit Range	Default	Access	Acronym	Description
15 : 00	0	RO	RSVD	Reserved

10.2.4 RID—Revision ID Register

Table 279. Offset 08h: RID – Revision ID

Size: 8 bit		Default: Refer to bit description		Power Well:
Access		PCI Configuration B:D:F 0:31:0		Offset Start: 08h Offset End: 08h
Bit Range	Default	Access	Acronym	Description
07 : 00	Refer to bit description	RWO	RID	Revision ID: Refer to the <i>Intel® Atom™ Processor E6xx Series Specification Update</i> for the value of the Revision ID Register. For the B-0 Stepping, this value is 01h. For the B-1 Stepping, this value is 02h.



10.2.5 CC—Class Code Register

Table 280. Offset 09h: CC – Class Code

Size: 24 bit		Default: 060100h		Power Well:
Access		PCI Configuration B:D:F X:31:0		Offset Start: 09h Offset End: 0Bh
Bit Range	Default	Access	Acronym	Description
23 : 16	06h	RO	BCC	Base Class Code: Indicates the device is a bridge device.
15 : 08	01h	RO	SCC	Sub-Class Code: Indicates the device a PCI to ISA bridge.
07 : 00	00h	RO	PI	Programming Interface: The LPC bridge has no programming interface.

10.2.6 HDTYPE—Header Type Register

Table 281. Offset 0Eh: HDTYPE – Header Type

Size: 8 bit		Default: 80h		Power Well:
Access		PCI Configuration B:D:F X:31:0		Offset Start: 0Eh Offset End: 0Eh
Bit Range	Default	Access	Acronym	Description
07	1	RO	MFD	Multi-function Device: This bit is '1' to indicate a multi-function device.
06 : 00	00h	RO	HTYPE	Header Type: Identifies the header layout is a generic device.

10.2.7 SS—Subsystem Identifiers Register

This register is initialized to logic 0 by the assertion of RESET_B. This register can be written only once after RESET_B de-assertion.

Table 282. Offset 2Ch: SS – Subsystem Identifiers

Size: 32 bit		Default: 00000000h		Power Well:
Access		PCI Configuration B:D:F X:31:0		Offset Start: 2Ch Offset End: 2Fh
Bit Range	Default	Access	Acronym	Description
31 : 16	0000h	RWO	SSID	Subsystem ID: This is written by BIOS. No hardware action is taken.
15 : 00	0000h	RWO	SSVID	Subsystem Vendor ID: This is written by BIOS. No hardware action is taken.

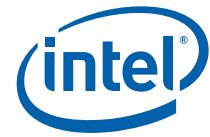

10.3 ACPI Device Configuration

10.3.1 SMBA—SMBus Base Address Register

Table 283. Offset 40h: SMBA – SMBus Base Address

Size: 32 bit		Default: 00000000h		Power Well:
Access		PCI Configuration B:D:F X:31:0		Offset Start: 40h Offset End: 43h
Bit Range	Default	Access	Acronym	Description
31	0	RW	EN	Enable: 1 = Decode of the I/O range pointed to by the SMBASE.BA field is enabled.
30 : 16	0h	RO	RSVD	Reserved.
15 : 06	0h	RW	BA	Base Address: This field provides the 64 bytes of I/O space for SMBus
05 : 00	0h	RO	RSVD	Reserved.

10.3.2 GBA—GPIO Base Address Register

Table 284. Offset 44h: GBA – GPIO Base Address

Size: 32 bit		Default: 00000000h		Power Well:
Access		PCI Configuration B:D:F X:31:0		Offset Start: 44h Offset End: 47h
Bit Range	Default	Access	Acronym	Description
31	0	RW	EN	Enable: 1 = Decode of the I/O range pointed to by the GPIOBASE.BA is enabled.
30 : 16	0h	RO	RSVD	Reserved.
15 : 06	0h	RW	BA	Base Address: This field provides the 64 bytes of I/O space for GPIO.
05 : 00	0h	RO	RSVD	Reserved.

10.3.3 PM1BLK—PM1_BLK Base Address Register

Table 285. Offset 48h: PM1BLK – PM1_BLK Base Address (Sheet 1 of 2)

Size: 32 bit		Default: 00000000h		Power Well:
Access		PCI Configuration B:D:F X:31:0		Offset Start: 48h Offset End: 4Bh
Bit Range	Default	Access	Acronym	Description
31	0	RW	EN	Enable: 1 = Decode of the I/O range pointed to by the PM1BASE.BA is enabled.
30 : 16	0h	RO	RSVD	Reserved.
15 : 04	0h	RW	BA	Base Address: This field provides the 64 bytes of I/O space for PM1_BLK.



Table 285. Offset 48h: PM1BLK – PM1_BLK Base Address (Sheet 2 of 2)

Size: 32 bit		Default: 00000000h		Power Well:
Access		PCI Configuration B:D:F X:31:0		Offset Start: 48h Offset End: 4Bh
Bit Range	Default	Access	Acronym	Description
03 : 00	0h	RO	RSVD	Reserved.

10.3.4 GPE0BLK—GPE0_BLK Base Address Register

Table 286. Offset 4Ch: GPE0BLK – GPE0_BLK Base Address

Size: 32 bit		Default: 00000000h		Power Well:
Access		PCI Configuration B:D:F X:31:0		Offset Start: 4Ch Offset End: 4Fh
Bit Range	Default	Access	Acronym	Description
31	0	RW	EN	Enable: 1 = Decode of the IO range pointed to by the GPE0BASE.BA is enabled.
30 : 16	0h	RO	RSVD	Reserved.
15 : 06	0h	RW	BA	Base Address: This field provides the 64 bytes of I/O space for GPE0_BLK.
05 : 00	0h	RO	RSVD	Reserved.

10.3.5 LPCS—LPC Clock Strength Control Register

The LPC Clock 2 and 1 are controlled via the SoftStrap software.

Table 287. Offset 54h: LPCS – LPC Clock Strength Control (Sheet 1 of 2)

Size: 32 bit		Default:		Power Well:
Access		PCI Configuration B:D:F X:31:0		Offset Start: 54h Offset End: 57h
Bit Range	Default	Access	Acronym	Description
31 : 19	0h	RO	RSVD	Reserved.
18	1b	RW	C2EN	Clock 2 Enable: 1 = Enabled. 0 = Disabled.
17	1b	RW	C1EN	Clock 1 Enable: 1 = Enabled. 0 = Disabled.
16 : 06	0h	RO	RSVD	Reserved
05	1b	RW	C22M	Clock 2 2m Strength: Clock 2 2m Strength Control
04	1b	RW	C24M	Clock 2 4m Strength: Clock 2 4m Strength Control
03	1b	RW	C12M	Clock 1 2m Strength: Clock 1 2m Strength Control
02	1b	RW	C14M	Clock 1 4m Strength: Clock 1 4m Strength Control
01	1b	RW	C02M	Clock 0 2m Strength: Clock 0 2m Strength Control



Table 287. Offset 54h: LPCS – LPC Clock Strength Control (Sheet 2 of 2)

Size: 32 bit		Default:		Power Well:
Access		PCI Configuration B:D:F X:31:0		Offset Start: 54h Offset End: 57h
Bit Range	Default	Access	Acronym	Description
00	Strap	RW	C04M	Clock 0 4m Strength: Clock 0 4m Strength Control

10.3.6 ACTL—ACPI Control Register

Table 288. Offset 58h: ACTL – ACPI Control

Size: 32 bit		Default: 00000003h		Power Well:																				
Access		PCI Configuration B:D:F X:31:0		Offset Start: 58h Offset End: 5Bh																				
Bit Range	Default	Access	Acronym	Description																				
31 : 03	0h	RO	RSVD	Reserved																				
02 : 00	011b	RW	SCIS	<p>SCI IRQ Select: This field specifies on which IRQ SCI will route to. If not using APIC, SCI must be routed to IRQ9-11, and that interrupt is not sharable with SERIRQ, but is shareable with other interrupts. If using APIC, SCI can be mapped to IRQ20-23, and can be shared with other interrupts.</p> <table border="1"> <thead> <tr> <th>Bits</th> <th>SCI Map</th> <th>Bits</th> <th>SCI Map</th> </tr> </thead> <tbody> <tr> <td>000</td> <td>IRQ9</td> <td>100</td> <td>IRQ20</td> </tr> <tr> <td>001</td> <td>IRQ10</td> <td>101</td> <td>IRQ21</td> </tr> <tr> <td>010</td> <td>IRQ11</td> <td>110</td> <td>IRQ22</td> </tr> <tr> <td>011</td> <td>SCI Disabled</td> <td>111</td> <td>IRQ23</td> </tr> </tbody> </table> <p>When the interrupt is mapped to APIC interrupts 9, 10 or 11, APIC must be programmed for active-high reception. When the interrupt is mapped to APIC interrupts 20 through 23, APIC must be programmed for active-low reception.</p>	Bits	SCI Map	Bits	SCI Map	000	IRQ9	100	IRQ20	001	IRQ10	101	IRQ21	010	IRQ11	110	IRQ22	011	SCI Disabled	111	IRQ23
Bits	SCI Map	Bits	SCI Map																					
000	IRQ9	100	IRQ20																					
001	IRQ10	101	IRQ21																					
010	IRQ11	110	IRQ22																					
011	SCI Disabled	111	IRQ23																					

10.3.7 MC - Miscellaneous Control Register

Table 289. Offset 5Ch: MC – Miscellaneous Control (Sheet 1 of 3)

Size: 32 bit		Default: 00000000h		Power Well:
Access		PCI Configuration B:D:F X:31:0		Offset Start: 5Ch Offset End: 5Fh
Bit Range	Default	Access	Acronym	Description
31 : 29	0h	RW	RSVD	Reserved
28	0h	RW	LPCFS	LPC Clock Frequency Select: '0'-1/2x of BB legacy clock; '1'-1x of BB legacy clock. This register value is only applicable when the LPC clock fuse is blown. when the fuse bit is '0', the LPCCLK frequency is 1x, irrespective of the value of this register.
27 : 24	0h	RW	NTT	Number of Timer Ticks to Count: Indicates how many timer ticks will be collected before a break event will be signalled to the power management controller. Up to 16 timer ticks may be collected.

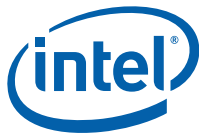
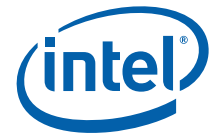

Table 289. Offset 5Ch: MC – Miscellaneous Control (Sheet 2 of 3)

Size: 32 bit		Default: 00000000h		Power Well:
Access		PCI Configuration		B:D:F X:31:0
Bit Range	Default	Access	Acronym	Description
23 : 21	0h	RO	RSVD	Reserved
20	0	RW	BTC6	Block Timer Ticks in C6: When set, timer ticks will be blocked up to NTT while the processor is in the C6 state. If not set, timer ticks will not be blocked in the C6 state.
31 : 29	0h	RW	RSVD	Reserved
19	0	RW	BTC5	Block Timer Ticks in C5: Same definition as BTC6, but for the C5 state.
18	0	RW	BTC4	Block Timer Ticks in C4: Same definition as BTC6, but for the C4 state.
17	0	RW	BTC3	Block Timer Ticks in C3: Same definition as BTC6, but for the C3 state.
16	0	RW	BTC2	Block Timer Ticks in C2: Same definition as BTC6, but for the C2 state.
15 : 13	0h	RO		Reserved
12	0	RW	BIC6	Block Interrupts in C6: When set, interrupts will be blocked while the processor is in the C6 state, until a timer tick occurs. If not set, interrupts will not be blocked in the C6 state. Blocking may occur for NTT timer ticks if BTC6 is set.
11	0	RW	BIC5	Block Interrupts in C5: Same definition as BIC6, but for the C5 state.
10	0	RW	BIC4	Block Interrupts in C4: Same definition as BIC6, but for the C4 state.
09	0	RW	BIC3	Block Interrupts in C3: Same definition as BIC6, but for the C3 state.
08	0	RW	BIC2	Block Interrupts in C2: Same definition as BIC6, but for the C2 state.
07	Strap	RO	MEMID3	Bootstrap MEMID3: Bootstrap for memory controller configuration ID3. Defines the number of ranks enabled. 1: 1 Rank 0: 2 Rank
06	Strap	RO	MEMID2	Bootstrap MEMID2: Bootstrap for memory controller configuration ID2. Defines the memory device densities that the processor is connected to. [MEMID2: MEMID1] 11: 2 Gb 10: 1 Gb 01: 512 Mb 00: 256 Mb
05	Strap	RO	MEMID1	Bootstrap MEMID1: Bootstrap for memory controller configuration ID1. Defines the memory device densities that the processor is connected to. Please refer to MEMID2.
04	Strap	RO	MEMID0	Bootstrap MEMID0: Bootstrap for memory controller configuration ID0. Defines the memory device width: 0: x16 devices 1: x8 devices
03	0	RW	DRTC	Disable RTC: When set, decodes to the RTC will be disabled, and the accesses instead will be sent to LPC. This allows testing to determine whether these functions are needed for XP and Vista.

**Table 289. Offset 5Ch: MC – Miscellaneous Control (Sheet 3 of 3)**

Size: 32 bit		Default: 0000000h		Power Well:
Access		PCI Configuration		Offset Start: 5Ch Offset End: 5Fh
		B:D:F X: 31:0		
Bit Range	Default	Access	Acronym	Description
02	0	RW	D8259	Disable 8259: When set, decodes to the 8259 will be disabled, and the accesses instead will be sent to LPC. This allows testing to determine whether these functions are needed for XP and Vista.
01	0	RW	D8254	Disable 8254: When set, decodes to the 8254 will be disabled, and the accesses instead will be sent to LPC. This allows testing to determine whether these functions are needed for XP and Vista.
00	0	RW	RSVD	Reserved

10.4 Interrupt Control

10.4.1 PxRC—PIRQx Routing Control Register

Offset 60h routes PIRQA, 61h routes PIRQB, 62h routes PIRQC, 63h routes PIRQD, 64h routes PIRQE, 65h routes PIRQF, 66h routes PIRQG, and 67h routes PIRQH.

Table 290. Offset 60h – 67h: PxRC – PIRQ[A-H] Routing Control

Size: 8 bit		Default: 80h		Power Well:																																				
Access		PCI Configuration		Offset Start: 60h Offset End: 67h																																				
		B:D:F X: 31:0																																						
Bit Range	Default	Access	Acronym	Description																																				
07	1	RW	REN	Interrupt Routing Enable (REN): 0 = The corresponding PIRQ is routed to one of the legacy interrupts specified in bits[3:0]. 1 = The PIRQ is not routed to the 8259. Note: BIOS must program this bit to 0 during POST for any of the PIRQs that are being used. The value of this bit may subsequently be changed by the OS when setting up for I/O APIC interrupt delivery mode.																																				
06 : 04	000b	RO	RSVD	Reserved																																				
03 : 00	0	RW	IR	IRQ Routing: Indicates how to route PIRQx_B <table border="1" style="margin-left: 20px;"> <thead> <tr> <th>Bits</th> <th>Mapping</th> <th>Bits</th> <th>Mapping</th> </tr> </thead> <tbody> <tr> <td>0h</td> <td>Reserved</td> <td>8h</td> <td>Reserved</td> </tr> <tr> <td>1h</td> <td>Reserved</td> <td>9h</td> <td>IRQ9</td> </tr> <tr> <td>2h</td> <td>Reserved</td> <td>Ah</td> <td>IRQ10</td> </tr> <tr> <td>3h</td> <td>IRQ3</td> <td>Bh</td> <td>IRQ11</td> </tr> <tr> <td>4h</td> <td>IRQ4</td> <td>Ch</td> <td>IRQ12</td> </tr> <tr> <td>5h</td> <td>IRQ5</td> <td>Dh</td> <td>Reserved</td> </tr> <tr> <td>6h</td> <td>IRQ6</td> <td>Eh</td> <td>IRQ14</td> </tr> <tr> <td>7h</td> <td>IRQ7</td> <td>Fh</td> <td>IRQ15</td> </tr> </tbody> </table>	Bits	Mapping	Bits	Mapping	0h	Reserved	8h	Reserved	1h	Reserved	9h	IRQ9	2h	Reserved	Ah	IRQ10	3h	IRQ3	Bh	IRQ11	4h	IRQ4	Ch	IRQ12	5h	IRQ5	Dh	Reserved	6h	IRQ6	Eh	IRQ14	7h	IRQ7	Fh	IRQ15
Bits	Mapping	Bits	Mapping																																					
0h	Reserved	8h	Reserved																																					
1h	Reserved	9h	IRQ9																																					
2h	Reserved	Ah	IRQ10																																					
3h	IRQ3	Bh	IRQ11																																					
4h	IRQ4	Ch	IRQ12																																					
5h	IRQ5	Dh	Reserved																																					
6h	IRQ6	Eh	IRQ14																																					
7h	IRQ7	Fh	IRQ15																																					

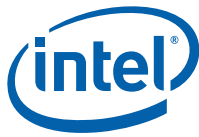

10.4.2 SCNT—Serial IRQ Control Register

Table 291. Offset 68h: SCNT – Serial IRQ Control

Size: 8 bit		Default: 80h		Power Well:
Access		PCI Configuration B:D:F X:31:0		Offset Start: 68h Offset End: 6Bh
Bit Range	Default	Access	Acronym	Description
07	0	RW	MD	Mode: This bit must be set to ensure that the first action of the processor is a start frame. 0 = Processor is in quiet mode 1 = Processor is in continuous mode
06 : 00	00h	RO	RSVD	Reserved

10.4.3 WDTBA-WDT Base Address

Table 292. Offset 84h: WDTBA – WDT Base Address

Size: 32 bit		Default: 00000000h		Power Well:
Access		PCI Configuration B:D:F X:31:0		Offset Start: 84h Offset End: 87h
Bit Range	Default	Access	Acronym	Description
31	0	RW	RW	Enable: When set, decode of the IO range pointed to by the BA is enabled.
30 : 16	0h		RO	Reserved. Always 0
15 : 06	0h		RW	Base Address: Provides the 64 bytes of I/O space for WDT.
05 : 00	0h	RO	RO	Reserved.

10.5 FWH Configuration Registers

10.5.1 FS—FWH ID Select Register

This register contains the IDSEL fields the LPC Bridge uses for memory cycles going to the FWH.

Note: The usage of FWH will not be validated or supported.

Table 293. Offset D0h: FS – FWH ID Select (Sheet 1 of 2)

Size: 32 bit		Default: 00112233h		Power Well:
Access		PCI Configuration B:D:F X:31:0		Offset Start: D0h Offset End: D3h
Bit Range	Default	Access	Acronym	Description
31 : 28	0h	RO	IF8	F8-FF IDSEL: IDSEL to use in FWH cycle for range enabled by BDE.EF8. The Address ranges are: FFF80000h – FFFFFFFFh, FFB80000h – FFBFFFFFFh and 000E0000h – 000FFFFFFh

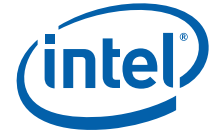

Table 293. Offset D0h: FS – FWH ID Select (Sheet 2 of 2)

Size: 32 bit		Default: 00112233h		Power Well:	
Access		PCI Configuration		B:D:F X:31:0	Offset Start: D0h Offset End: D3h
Bit Range	Default	Access	Acronym	Description	
27 : 24	0h	RW	IFO	F0-F7 IDSEL: IDSEL to use in FWH cycle for range enabled by BDE.EF0. The Address ranges are: FFF00000h – FFF7FFFFh, FFB00000h – FFB7FFFFh	
23 : 20	1h	RW	IE8	E8-EF IDSEL: IDSEL to use in FWH cycle for range enabled by BDE.EE8. The Address ranges are: FFE80000h – FFEFFFFFh, FFA80000h – FFAFFFFFh	
19 : 16	1h	RW	IE0	E0-E7 IDSEL: IDSEL to use in FWH cycle for range enabled by BDE.EE0. The Address ranges are: FFE00000h – FFE7FFFFh, FFA00000h – FFA7FFFFh	
15 : 12	2h	RW	ID8	D8-DF IDSEL: IDSEL to use in FWH cycle for range enabled by BDE.ED8. The Address ranges are: FFD80000h – FFDFFFFFh, FF980000h – FF97FFFFh	
11 : 08	2h	RW	ID0	D0-D7 IDSEL: IDSEL to use in FWH cycle for range enabled by BDE.ED0. The Address ranges are: FFD00000h – FFD7FFFFh, FF900000h – FF97FFFFh	
07 : 04	3h	RW	IC8	C8-CF IDSEL: IDSEL to use in FWH cycle for range enabled by BDE.EC8. The Address ranges are: FFC80000h – FFCFFFFFh, FF880000h – FF87FFFFh	
03 : 00	3h	RW	IC0	C0-C7 IDSEL: IDSEL to use in FWH cycle for range enabled by BDE.EC0. The Address ranges are: FFC00000h – FFC7FFFFh, FF800000h – FF87FFFFh	

10.5.2 BDE—BIOS Decode Enable

Table 294. Offset D4h: BDE – BIOS Decode Enable (Sheet 1 of 2)

Size: 32 bit		Default: FF000000h		Power Well:	
Access		PCI Configuration		B:D:F X:31:0	Offset Start: D4h Offset End: D7h
Bit Range	Default	Access	Acronym	Description	
31	1b	RO	EF8	F8-FF Enable: Enables decoding of BIOS range FFF80000h – FFFFFFFFh and FFB80000h – FFBFFFFFh. 0 = Disable 1 = Enable	
30	1b	RW	EF0	F0-F8 Enable: Enables decoding of BIOS range FFF00000h – FFF7FFFFh and FFB00000h – FFB7FFFFh. 0 = Disable 1 = Enable	
29	1b	RW	EE8	E8-EF Enable: Enables decoding of BIOS range FFE80000h – FFEFFFFFh and FFA80000h – FFAFFFFFh. 0 = Disable 1 = Enable	
28	1b	RW	EE0	E0-E8 Enable: Enables decoding of BIOS range FFE00000h – FFE7FFFFh and FFA00000h – FFA7FFFFh. 0 = Disable 1 = Enable	



Table 294. Offset D4h: BDE – BIOS Decode Enable (Sheet 2 of 2)

Size: 32 bit		Default: FF00000h		Power Well:
Access		PCI Configuration B:D:F X:31:0		Offset Start: D4h Offset End: D7h
Bit Range	Default	Access	Acronym	Description
27	1b	RW	ED8	D8-DF Enable: Enables decoding of BIOS range FFD80000h – FFDFFFFFFh and FF980000h – FF9FFFFFFh. 0 = Disable, 1 = Enable
26	1b	RW	ED0	D0-D7 Enable: Enables decoding of BIOS range FFD00000h – FFD7FFFFFFh and FF900000h – FF97FFFFFFh. 0 = Disable 1 = Enable
25	1b	RW	EC8	C8-CF Enable: Enables decoding of BIOS range FFC80000h – FFCFFFFFFh and FF880000h – FF8FFFFFFh. 0 = Disable 1 = Enable
24	1b	RW	EC0	C0-C7 Enable: Enables decoding of BIOS range FFC00000h – FFC7FFFFFFh and FF800000h – FF87FFFFFFh. 0 = Disable 1 = Enable
23 : 00	000000h	RO	RSVD	Reserved

10.5.3 BC—BIOS Control Register

Table 295. Offset D8h: BC – BIOS Control (Sheet 1 of 2)

Size: 32 bit		Default: 00000100h		Power Well:
Access		PCI Configuration B:D:F X:31:0		Offset Start: D8h Offset End: DBh
Bit Range	Default	Access	Acronym	Description
31 : 09	0h	RO	RSVD	Reserved
08	1b	RW	PFE	Prefetch Enable: 0 = Disable. 1 = Enable BIOS prefetching. An access to BIOS causes a 64-byte fetch of the line starting at that region. Subsequent accesses within that region result in data being returned from the prefetch buffer. Note: The prefetch buffer is invalidated when this bit is cleared, or a BIOS access occurs to a different line than what is currently in the buffer.
07 : 03	000000b	RO	RSVD	Reserved
02	0b	RW	CD	Cache Disable: Enable caching in read buffer for direct memory read.
01	0b	RWLO	LE	Lock Enable: When set, setting the WP bit will cause SMIs. When cleared, setting the WP bit will not cause SMIs. Once set, this bit can only be cleared by a RESET_B. 0 = Setting the BIOSWE will not cause SMIs. 1 = Enables setting the BIOSWE bit to cause SMIs. Once set, this bit can only be cleared by a RESET_B.



Table 295. Offset D8h: BC – BIOS Control (Sheet 2 of 2)

Size: 32 bit		Default: 00000100h		Power Well:
Access		PCI Configuration B:D:F X:31:0		Offset Start: D8h Offset End: DBh
Bit Range	Default	Access	Acronym	Description
00	0b	RW	WP	Write Protect: When set, access to BIOS is enabled for both read and write cycles. When cleared, only read cycles are permitted to BIOS. When written from a 0 to a 1 and LE is also set, an SMI_B is generated. This ensures that only SMM code can update BIOS.

10.6 Root Complex Register Block Configuration

10.6.1 RCBA—Root Complex Base Address Register

Table 296. Offset F0h: RCBA – Root Complex Base Address

Size: 32 bit		Default: 00000000h		Power Well:
Access		PCI Configuration B:D:F X:31:0		Offset Start: F0h Offset End: F3h
Bit Range	Default	Access	Acronym	Description
31 : 14	0h	RW	BA	Base Address: Base Address for the root complex register block decode range. This address is aligned on a 16KB boundary.
13 : 01	0h	RO	RSVD	Reserved
00	0	RW	EN	Enable: 1 = Enables the range specified in BA to be claimed as the RCRB.

§ §



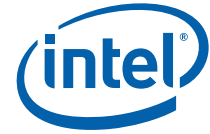

11.0 ACPI Devices

11.1 8254 Timer

The 8254 contains three counters which have fixed uses. All registers are in the core well and clocked by a 14.31818 MHz clock.

11.1.1 Counter 0, System Timer

This counter functions as the system timer by controlling the state of IRQ0 and is programmed for Mode 3 operation. The counter produces a square wave with a period equal to the product of the counter period (838 ns) and the initial count value. The counter loads the initial count value one counter period after software writes the count value to the counter I/O address. The counter initially asserts IRQ0 and decrements the count value by two each counter period. The counter negates IRQ0 when the count value reaches 0. It then reloads the initial count value and again decrements the initial count value by two each counter period. The counter then asserts IRQ0 when the count value reaches 0, reloads the initial count value, and repeats the cycle, alternately asserting and negating IRQ0.

11.1.2 Counter 1, Refresh Request Signal

This counter is programmed for Mode 2 operation and impacts the period of the NSC.RTS. Programming the counter to anything other than Mode 2 results in undefined behavior.

11.1.3 Counter 2, Speaker Tone

This counter provides the speaker tone and is typically programmed for Mode 3 operation.

11.1.4 Timer I/O Registers

Table 297. Timer I/O Registers

Port	Register Name/Function	Default Value	Type
40h/50h	Counter 0 Interval Time Status Byte Format	0XXXXXXXXb	Read Only
	Counter 0 Counter Access Port Register	Undefined	Read/Write
41h/51h	Counter 1 Interval Time Status Byte Format	0XXXXXXXXb	Read Only
	Counter 1 Counter Access Port Register	Undefined	Read/Write
42h/52h	Counter 2 Interval Time Status Byte Format	0XXXXXXXXb	Read Only
	Counter 2 Counter Access Port Register	Undefined	Read/Write
43h/53h	Timer Control Word Register	Undefined	Write Only
	Timer Control Word Register Read Back	XXXXXXXX0b	Write Only
	Counter Latch Command	X0h	Write Only

11.1.5 Offset 43h: TCW - Timer Control Word Register

This register is programmed prior to any counter being accessed to specify counter modes. Following reset, the control words for each register are undefined and each counter output is 0. Each timer must be programmed to bring it into a known state.



Table 298. 43h: TCW - Timer Control Word Register

Size: 8 bit		Default: Undefined		Power Well: Core
Access		Fixed IO Address: 43h		
Bit Range	Default	Access	Acronym	Description
07 : 06	Undef	WO	CS	Counter Select: The Counter Selection bits select the counter the control word acts upon as shown below. The Read Back Command is selected when bits[7:6] are both 1. 00 = Counter 0 select 01 = Counter 1 select 10 = Counter 2 select 11 = Read Back Command
05 : 04	Undef	WO	RWS	Read/Write Select: The counter programming is done through the counter port (40h for counter 0, 41h for counter 1, and 42h for counter 2) 00 = Counter Latch Command 01 = Read/Write Least Significant Byte (LSB) 10 = Read/Write Most Significant Byte (MSB) 11 = Read/Write LSB then MSB
03 : 01	Undef	WO	CMS	Counter Mode Selection: Selects one of six modes of operation for the selected counter. 000 = Out signal on end of count (=0) 001 = Hardware retriggerable one-shot x10 = Rate generator (divide by n counter) x11 = Square wave output 100 = Software triggered strobe 101 = Hardware triggered strobe
00	Undef	WO	BCS	Binary/BCD Countdown Select: 0 = Binary countdown is used. The largest possible binary count is 2^{16} 1 = Binary coded decimal (BCD) count is used. The largest possible BCD count is 10^4

There are two special commands that can be issued to the counters through this register, the Read Back Command and the Counter Latch Command. When these commands are chosen, several bits within this register are redefined. These register formats are described below.

11.1.5.1 Read Back Command

This is used to determine the count value, programmed mode, and current states of the OUT pin and Null count flag of the selected counter or counters. Status and/or count may be latched in any or all of the counters by selecting the counter during the register write. The count and status remain latched until read, and further latch commands are ignored until the count is read.

Both count and status of the selected counters may be latched simultaneously by setting both bit 5 and bit 4 to 0. If both are latched, the first read operation from that counter returns the latched status. The next one or two reads, depending on whether the counter is programmed for one or two byte counts, returns the latched count. Subsequent reads return an unlatched count.



Table 299. 43h: RBC – Read Back Command

Size: 8 bit		Default: XXXXXX0b		Power Well: Core
Access		Fixed IO Address: 43h		
Bit Range	Default	Access	Acronym	Description
07 : 06	00	RW	RBC	Read Back Command: Must be "11" to select the Read Back Command
05	0	RW	LC	Latch Count: When cleared, the current count value of the selected counters will be latched
04	0	RW	LS	Latch Status: When cleared, the status of the selected counters will be latched
03	0	RW	C2S	Counter 2 Select: When set to 1, Counter 2 count and/or status will be latched
02	0	RW	C1S	Counter 1 Select: When set to 1, Counter 1 count and/or status will be latched
01	0	RW	C0S	Counter 0 Select: When set to 1, Counter 0 count and/or status will be latched.
00	0	RO	RSVD	Reserved

11.1.5.2 Counter Latch Command

This latches the current count value and is used to ensure the count read from the counter is accurate. The count value is then read from each counter's count register through the Counter Ports Access Ports Register (40h for counter 0, 41h for counter 1, and 42h for counter 2). The count must be read according to the programmed format, i.e., if the counter is programmed for two byte counts, two bytes must be read. The two bytes do not have to be read one right after the other (read, write, or programming operations for other counters may be inserted between the reads). If a counter is latched once and then latched again before the count is read, the second Counter Latch Command is ignored.

Table 300. 43h: CLC – Counter Latch Command

Size: 8 bit		Default: X0h		Power Well: Core
Access		Fixed IO Address: 43h		
Bit Range	Default	Access	Acronym	Description
07 : 06	00	RW	CL	Counter Selection: Selects the counter for latching. If "11" is written, then the write is interpreted as a read back command. 00 = Counter 0 01 = Counter 1 10 = Counter 2
05 : 04	0	RW		Counter Latch Command: Write "00" to select the Counter Latch Command.
03 : 00	0	RO	RSVD	Reserved. Must be 0.

11.1.5.3 Offset 40h, 41h, 42h: Interval Timer Status Byte Format Register

Each counter's status byte can be read following a Read Back Command. If latch status is chosen (bit 4=0, Read Back Command) as a read back option for a given counter, the next read from the counter's Counter Access Ports Register (40h for counter 0, 41h for counter 1, and 42h for counter 2) returns the status byte. The status byte returns the following:



Table 301. 40h, 41h, 42h: Interval Timer Status Byte Format Register

Size: 8 bit		Default: 0XXXXXXb		Power Well: Core																					
Access		PCI Configuration		B:D:F																					
Offset Start: 40h, 41h, 42h		Offset End:																							
Bit Range	Default	Access	Acronym	Description																					
07	0	RO	CL	Counter State: When set, OUT of the counter is set. When cleared, OUT of the counter is 0.																					
06	Undef	RO		Count Register: When cleared, indicates when the last count written to the Count Register (CR) has been loaded into the counting element (CE) and is available for reading. The time this happens depends on the counter mode.																					
05 : 04	Undef	RO		Read/Write Selection: These reflect the read/write selection made through bits[5:4] of the control register. The binary codes returned during the status read match the codes used to program the counter read/write selection. 00 = Counter Latch Command 01 = Read/Write Least Significant Byte (LSB) 10 = Read/Write Most Significant Byte (MSB) 11 = Read/Write LSB then MSB																					
03 : 01	Undef	RO	RSVD	Mode: Returns the counter mode programming. The binary code returned matches the code used to program the counter mode, as listed under the bit function above. <table border="1" style="margin-left: 20px;"> <thead> <tr> <th>Bits</th> <th>Mode</th> <th>Description</th> </tr> </thead> <tbody> <tr> <td>000</td> <td>0</td> <td>Out signal on end of count (=0)</td> </tr> <tr> <td>001</td> <td>1</td> <td>Hardware retriggerable one-shot</td> </tr> <tr> <td>x10</td> <td>2</td> <td>Rate generator (divide by n counter)</td> </tr> <tr> <td>x11</td> <td>3</td> <td>Square wave output</td> </tr> <tr> <td>100</td> <td>4</td> <td>Software triggered strobe</td> </tr> <tr> <td>101</td> <td>5</td> <td>Hardware triggered strobe</td> </tr> </tbody> </table>	Bits	Mode	Description	000	0	Out signal on end of count (=0)	001	1	Hardware retriggerable one-shot	x10	2	Rate generator (divide by n counter)	x11	3	Square wave output	100	4	Software triggered strobe	101	5	Hardware triggered strobe
Bits	Mode	Description																							
000	0	Out signal on end of count (=0)																							
001	1	Hardware retriggerable one-shot																							
x10	2	Rate generator (divide by n counter)																							
x11	3	Square wave output																							
100	4	Software triggered strobe																							
101	5	Hardware triggered strobe																							

11.1.5.4 Offset 40h, 41h, 42h: Counter Access Ports Register

Table 302. 40h, 41h, 42h: Counter Access Ports Register

Size: 8 bit		Default: Undefined		Power Well: Core
Access		PCI Configuration		B:D:F
Offset Start: 40h, 41h, 42h		Offset End:		
Bit Range	Default	Access	Acronym	Description
07 : 00	Undef	RW		Counter Port: Each counter port address is used to program the 16-bit Count Register. The order of programming, either LSB only, MSB only, or LSB then MSB, is defined with the Interval Counter Control Register at port 43h. The counter port is also used to read the current count from the Count Register, and return the status of the counter programming following a Read Back Command.

11.1.6 Timer Programming

The counter/timers are programmed in the following fashion:

1. Write a control word to select a counter
2. Write an initial count for that counter.



3. Load the least and/or most significant bytes (as required by Control Word bits 5, 4) of the 16-bit counter.
4. Repeat with other counters

Only two conventions need to be observed when programming the counters. First, for each counter, the control word must be written before the initial count is written. Second, the initial count must follow the count format specified in the control word (least significant byte only, most significant byte only, or least significant byte and then most significant byte).

A new initial count may be written to a counter at any time without affecting the counter's programmed mode. Counting will be affected as described in the mode definitions. The new count must follow the programmed count format.

If a counter is programmed to read/write two-byte counts, the following precaution applies: A program must not transfer control between writing the first and second byte to another routine which also writes into that same counter. Otherwise, the counter will be loaded with an incorrect count.

The Control Word Register at port 43h controls the operation of all three counters. Several commands are available:

- **Control Word Command:** Specifies which counter to read or write, the operating mode, and the count format (binary or BCD).
- **Counter Latch Command:** Latches the current count so that it can be read by the system. The countdown process continues.
- **Read Back Command:** Reads the count value, programmed mode, the current state of the OUT pins, and the state of the Null Count Flag of the selected counter.

11.1.7 Reading from the Interval Timer

It is often desirable to read the value of a counter without disturbing the count in progress. There are three methods for reading the counters: a simple read operation, counter Latch Command, and the Read-Back Command. Each is explained below.

With the simple read and counter latch command methods, the count must be read according to the programmed format; specifically, if the counter is programmed for two byte counts, two bytes must be read. The two bytes do not have to be read one right after the other. Read, write, or programming operations for other counters may be inserted between them.

11.1.7.1 Simple Read

The first method is to perform a simple read operation. The counter is selected through port 40h (counter 0), 41h (counter 1), or 42h (counter 2).

Note, performing a direct read from the counter will not return a determinate value, because the counting process is asynchronous to read operations. However, in the case of counter 2, the count can be stopped by writing to NSC.TC2E.

11.1.7.2 Counter Latch Command

The Counter Latch Command, written to port 43h, latches the count of a specific counter at the time the command is received. This command is used to ensure that the count read from the counter is accurate, particularly when reading a two-byte count. The count value is then read from each counter's Count Register as was programmed by the Control Register.



The count is held in the latch until it is read or the counter is reprogrammed. The count is then unlatched. This allows reading the contents of the counters on the fly without affecting counting in progress. Multiple Counter Latch Commands may be used to latch more than one counter. Counter Latch Commands do not affect the programmed mode of the counter in any way.

If a Counter is latched and then, some time later, latched again before the count is read, the second Counter Latch Command is ignored. The count read will be the count at the time the first Counter Latch Command was issued.

11.1.7.3 Read Back Command

The Read Back Command, written to port 43h, latches the count value, programmed mode, and current states of the OUT pin and Null Count flag of the selected counter or counters. The value of the counter and its status may then be read by I/O access to the counter address.

The Read Back Command may be used to latch multiple counter outputs at one time. This single command is functionally equivalent to several counter latch commands, one for each counter latched. Each counter's latched count is held until it is read or reprogrammed. Once read, a counter is unlatched. The other counters remain latched until they are read. If multiple count Read Back Commands are issued to the same counter without reading the count, all but the first are ignored.

The Read Back Command may additionally be used to latch status information of selected counters. The status of a counter is accessed by a read from that counter's I/O port address. If multiple counter status latch operations are performed without reading the status, all but the first are ignored.

Both count and status of the selected counters may be latched simultaneously. This is functionally the same as issuing two consecutive, separate Read Back Commands. If multiple count and/or status Read Back Commands are issued to the same counters without any intervening reads, all but the first are ignored.

If both count and status of a counter are latched, the first read operation from that counter will return the latched status, regardless of which was latched first. The next one or two reads, depending on whether the counter is programmed for one or two type counts, return the latched count. Subsequent reads return unlatched count.

11.2 High Precision Event Timer

This function provides a set of timers to be used by the operating system for timing events. One timer block is implemented, containing one counter and 3 timers.

11.2.1 Registers

The register space is memory mapped to a 1K block at address FED00000h. All registers are in the core well and reset by RESET#. Accesses that cross register boundaries result in undefined behavior.

Table 303. HPET Registers (Sheet 1 of 2)

Start	End	Symbol	Register
000	007	GCID	General Capabilities and ID
010	017	GC	General Configuration
020	027	GIS	General Interrupt Status
0F0	0F7	MCV	Main Counter Value

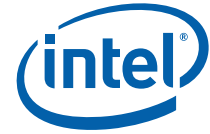

Table 303. HPET Registers (Sheet 2 of 2)

Start	End	Symbol	Register
100	107	T0C	Timer 0 Config and Capabilities
108	10F	T0CV	Timer 0 Comparator Value
120	127	T1C	Timer 1 Config and Capabilities
128	12F	T1CV	Timer 1 Comparator Value
140	147	T2C	Timer 2 Config and Capabilities
148	14F	T2CV	Timer 2 Comparator Value

11.2.1.1 Offset 000h: GCID – General Capabilities and ID

Table 304. 000h: GCID – General Capabilities and ID

Size: 64 bit		Default: Undefined		Power Well: Core
Access		PCI Configuration B:D:F		Offset Start: 000h Offset End: 007h
Bit Range	Default	Access	Acronym	Description
63 : 32	0429B17Fh	RO	CTP	Counter Tick Period: Indicates a period of 69.841279ns, (14.1318 MHz clock period)
31 : 16	8086h	RO	VID	Vendor ID: Value of 8086h indicates Intel.
15	1	RO	LRC	Legacy Rout Capable: Indicates support for Legacy Interrupt Rout.
14	0	RO	RSVD	Reserved
13	1	RO	CS	Counter Size: This bit is set to indicate that the main counter is 64 bits wide.
12 : 08	02h	RO	NT	Number of Timers: Indicates that 3 timers are supported.
07 : 00	01h	RO	RID	Revision ID: Indicates that revision 1.0 of the specification is implemented.

11.2.1.2 Offset 010h: GC – General Configuration

Table 305. 010h: GC – General Configuration

Size: 64 bit		Default:		Power Well: Core
Access		PCI Configuration B:D:F		Offset Start: 010h Offset End: 017h
Bit Range	Default	Access	Acronym	Description
63 : 02	0	RO	RSVD	Reserved
01	0	RW	LRE	Legacy Route Enable: When set, interrupts will be routed as follows: <ul style="list-style-type: none"> • Timer 0 will be routed to IRQ0 in 8259 or IRQ2 in the I/O APIC • Timer 1 will be routed to IRQ8 in 8259 and I/O APIC • Timer 2 will be routed as per the routing in T2C When set, the TNC.IR will have no impact for timers 0 and 1.
00	0	RW	EN	Overall Enable: When set, the timers can generate interrupts. When cleared, the main counter will halt and no interrupts will be caused by any timer. For level-triggered interrupts, if an interrupt is pending when this bit is cleared, the GIS.Tx will not be cleared.

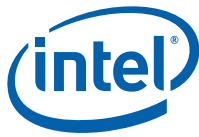

11.2.1.3 Offset 020h: GIS – General Interrupt Status

Table 306. 020h: GIS – General Interrupt Status

Size: 64 bit		Default:		Power Well: Core
Access		PCI Configuration B:D:F		Offset Start: 020h Offset End: 027h
Bit Range	Default	Access	Acronym	Description
63 :03	0	RO	RSVD	Reserved
02	0	RWC	T2	Timer 2 Status: Same functionality as T0, for timer 2.
01	0	RWC	T1	Timer 1 Status: Same functionality as T0, for timer 1.
00	0	RWC	T0	Timer 0 Status: In edge triggered mode, this bit always reads as 0. In level triggered mode, this bit is set when an interrupt is active.

11.2.1.4 Offset 0F0h: MCV – Main Counter Value

Table 307. 0F0h: MCV – Main Counter Value

Size: 64 bit		Default:		Power Well: Core
Access		PCI Configuration B:D:F		Offset Start: 0F0h Offset End: 0F7h
Bit Range	Default	Access	Acronym	Description
63 :00	0	RW	CV	Counter Value: Reads return the current value of the counter. Writes load the new value to the counter. Timers 1 and 2 return 0 for the upper 32-bits of this register.

11.2.1.5 Offset 100h, 120h, 140h: T[0-2]C – Timer [0-2] Config and Capabilities

Table 308. 100h, 120h, 140h: T[0-2]C – Timer [0-2] Config and Capabilities (Sheet 1 of 2)

Size: 64 bit		Default:		Power Well: Core
Access		PCI Configuration B:D:F		Offset Start: 100h, 120h, 140h Offset End: 107h, 127h, 147h
Bit Range	Default	Access	Acronym	Description
63 :32	See Desc	RO	IRC	Interrupt Rout Capability: Indicates I/OxAPIC interrupts the timer can use: <ul style="list-style-type: none"> Timer 0, 1: 00f00000h. Indicates support for IRQ20, 21, 22, 23 Timer 2: 00f00800h. Indicates support for IRQ11, 20, 21, 22, and 23
31 :16	0	RO	RSVD	Reserved
15	0	RO	FID	FSB Interrupt Delivery: Not supported
14	0	RO	FE	FSB Enable: Not supported, since FID is not supported.
13 :9	00h	RW	IR	Interrupt Rout: Indicates the routing for the interrupt to the IOxAPIC. If the value is not supported by this particular timer, the value read back will not match what is written. If GC.LRE is set, then Timers 0 and 1 have a fixed routing, and this field has no effect.
08	0	RO/RW	T32M	Timer 32-bit Mode: When set, this bit forces a 64-bit timer to behave as a 32-bit timer. For timer 0, this bit will be read/write and default to 0. For timers 1 and 2, this bit is read only '0'.

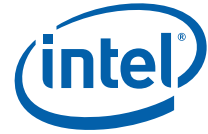

Table 308. 100h, 120h, 140h: T[0-2]C – Timer [0-2] Config and Capabilities (Sheet 2 of 2)

Size: 64 bit		Default:		Power Well: Core
Access		PCI Configuration		B:D:F
Bit Range	Default	Access	Acronym	Description
07	0	RO	RSVD	Reserved
06	0	RO/RW	TVS	Timer Value Set: This bit will return 0 when read. Writes will only have an effect for Timer 0 if it is set to periodic mode. Writes will have no effect for Timers 1 and 2.
05	0/1	RO	TS	Timer Size: 1 = 64-bits, 0 = 32-bits. Set for timer 0. Cleared for timers 1 and 2.
04	0/1	RO	PIC	Periodic Interrupt Capable: When set, hardware supports a periodic mode for this timer's interrupt. This bit is set for timer 0, and cleared for timers 1 and 2.
03	0	RO/RW	TYP	Timer Type: If PIC is set, this bit is read/write, and can be used to enable the timer to generate a periodic interrupt. This bit is RW for timer 0, and RO for timers 1 and 2.
02	0	RW	IE	Interrupt Enable: When set, enables the timer to cause an interrupt when it times out. When cleared, the timer count and generates status bits, but will not cause an interrupt.
01	0	RW	IT	Timer Interrupt Type: When cleared, interrupt is edge triggered. When set, interrupt is level triggered and will be held active until it is cleared by writing '1' to GIS.Tn. If another interrupt occurs before the interrupt is cleared, the interrupt remains active.
00	0	RO	RSVD	Reserved

11.2.1.6 Offset 108h, 128h, 148h: T[0-2]CV – Timer [0-2] Comparator Value

Reads to this register return the current value of the comparator. The default value for each timer is all 1's for the bits that are implemented. Timer 0 is 64-bits wide. Timers 1 and 2 are 32-bits wide.



Table 309. 108h, 128h, 148h: T[0-2]CV – Timer [0-2] Comparator Value

Size: 64 bit		Default:		Power Well: Core
Access		PCI Configuration	B:D:F	
Offset Start: 108h, 128h, 148h		Offset End: 10Fh, 12Fh, 14Fh		
Bit Range	Default	Access	Acronym	Description
63 :0	See Desc	RW		<p>Timer Compare Value — R/W. Reads to this register return the current value of the comparator</p> <p>Timers 0, 1, or 2 are configured to non-periodic mode:</p> <p>Writes to this register load the value against which the main counter should be compared for this timer.</p> <p>When the main counter equals the value last written to this register, the corresponding interrupt can be generated (if so enabled). The value in this register does not change based on the interrupt being generated.</p> <p>Timer 0 is configured to periodic mode:</p> <p>When the main counter equals the value last written to this register, the corresponding interrupt can be generated (if so enabled). After the main counter equals the value in this register, the value in this register is increased by the value last written to the register.</p> <p>As each periodic interrupt occurs, the value in this register will increment. When the incremented value is greater than the maximum value possible for this register (FFFFFFFFh for a 32-bit timer or FFFFFFFFFFFFFFFFh for a 64-bit timer), the value will wrap around through 0. For example, if the current value in a 32-bit timer is FFFF0000h and the last value written to this register is 20000, then after the next interrupt the value will change to 00010000h</p> <p>Default value for each timer is all 1s for the bits that are implemented. For example, a 32-bit timer has a default value of 00000000FFFFFFFFh. A 64-bit timer has a default value of FFFFFFFFFFFFFFFFh.</p>

11.2.2 Theory Of Operation

11.2.2.1 Non-Periodic Mode – All timers

This mode can be thought of as creating a one-shot. When a timer is set up for non-periodic mode, it generates an interrupt when the value in the main counter matches the value in the timer’s comparator register. As timers 1 and 2 are 32-bit, they will generate another interrupt when the main counter wraps.

TOCV cannot be programmed reliably by a single 64-bit write in a 32-bit environment unless only the periodic rate is being changed. If TOCV needs to be reinitialized, the following algorithm is performed:

1. Set TOC.TVS
2. Set the lower 32 bits of TOCV
3. Set TOC.TVS
4. Set the upper 32 bits of TOCV

Every timer is required to support the non-periodic mode of operation.

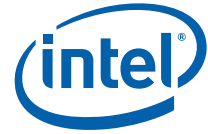

11.2.2.2 Periodic Mode – Timer 0 only

When set up for periodic mode, when the main counter value matches the value in TOCV, an interrupt is generated (if enabled). Hardware then increases TOCV by the last value written to TOCV. During run-time, TOCV can be read to find out when the next periodic interrupt will be generated. Software is expected to remember the last value written to TOCV.

Example: if the value written to TOCV is 00000123h, then

- An interrupt will be generated when the main counter reaches 00000123h.
- TOCV will then be adjusted to 00000246h.
- Another interrupt will be generated when the main counter reaches 00000246h
- TOCV will then be adjusted to 00000369h
- When the incremented value is greater than the maximum value possible for TnCV, the value will wrap around through 0. For example, if the current value in a 32-bit timer is FFFF0000h and the last value written to this register is 20000, then after the next interrupt the value will change to 00010000h

If software wants to change the periodic rate, it writes a new value to TOCV. When the timer's comparator matches, the new value is added to derive the next matching point. If software resets the main counter, the value in the comparator's value register must also be reset by setting TOC.TVS. To avoid race conditions, this should be done with the main counter halted. The following usage model is expected:

1. Software clears GC.EN to prevent any interrupts
2. Software clears the main counter by writing a value of 00h to it.
3. Software sets TOC.TVS.
4. Software writes the new value in TOCV
5. Software sets GC.EN to enable interrupts.

11.2.2.3 Interrupts

If each timer has a unique interrupt and the timer has been configured for edge-triggered mode, then there are no specific steps required. If configured to level-triggered mode, then its interrupt must be cleared by software by writing a '1' back to the bit position for the interrupt to be cleared.

Interrupts associated with the various timers have two interrupt mapping options. Software should mask GC.LRE when reprogramming HPET interrupt routing to avoid spurious interrupts.

11.2.2.3.1 Mapping Option #1: Legacy Option (GC.LRE set)

This forces the following mapping:

Table 310. Timer Interrupt Mapping: Legacy Option

Timer	8259 Mapping	APIC Mapping	Comment
0	IRQ0	IRQ2	The 8254 timer will not cause any interrupts
1	IRQ8	IRQ8	RTC will not cause any interrupts.
2	T2C.IRQ	T2C.IRC	

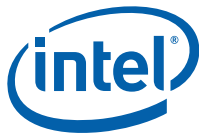

11.2.2.4 Mapping Option #2: Standard Option (GC.LRE cleared)

Each timer has its own routing control. The interrupts can be routed to various interrupts in the I/O APIC. TnC.IRC indicates which interrupts are valid options for routing. If a timer is set for edge-triggered mode, the timers should not be shared with any other interrupts.

11.3 8259 Interrupt Controller

11.3.1 Overview

The ISA compatible interrupt controller (8259) incorporates the functionality of two 8259 interrupt controllers. The following table shows how the cores are connected:

Table 311. Master 8259 Input Mapping

8259 Input	Connected Pin / Function
0	Internal Timer / Counter 0 output or Multimedia Timer #0
1	IRQ1 via SERIRQ
2	Slave Controller INTR output
3	IRQ3 via SERIRQ, PIRQx
4	IRQ4 via SERIRQ, PIRQx
5	IRQ5 via SERIRQ, PIRQx
6	IRQ6 via SERIRQ, PIRQx
7	IRQ7 via SERIRQ, PIRQx

Table 312. Slave 8259 Input Mapping

8259 Input	Connected Pin / Function
0	Inverted IRQ8# from internal RTC or HPET
1	IRQ9 via SERIRQ, SCI, or PIRQx
2	IRQ10 via SERIRQ, SCI, or PIRQx
3	IRQ11 via SERIRQ, SCI, or PIRQx
4	IRQ12 via SERIRQ, SCI, or PIRQx
5	PIRQx
6	IDEIRQ, SERIRQ, PIRQx
7	PIRQx

The slave controller is cascaded onto the master controller through master controller interrupt input 2. Interrupts can individually be programmed to be edge or level, except for IRQ0, IRQ2, IRQ8#. Active-low interrupt sources, such as the PIRQ#s, are internally inverted before being sent to the 8259. In the following descriptions of the 8259's, the interrupt levels are in reference to the signals at the internal interface of the 8259's, after the required inversions have occurred. Therefore, the term "high" indicates "active", which means "low" on an originating PIRQ#.



11.3.2 I/O Registers

The interrupt controller registers are located at 20h and 21h for the master controller (IRQ0 - 7), and at A0h and A1h for the slave controller (IRQ8 - 13). These registers have multiple functions, depending upon the data written to them. Below is a description of the different register possibilities for each address:

Table 313. 8259 I/O Register Mapping

Port	Aliases	Register Name/Function
20h	24h, 28h, 2Ch, 30h, 34h, 38h, 3Ch	Master 8259 ICW1 Init. Cmd Word 1 Register
		Master 8259 OCW2 Op Ctrl Word 2 Register
		Master 8259 OCW3 Op Ctrl Word 3 Register
21h	25h, 29h, 2Dh, 31h, 35h, 39h, 3Dh	Master 8259 ICW2 Init. Cmd Word 2 Register
		Master 8259 ICW3 Init. Cmd Word 3 Register
		Master 8259 ICW4 Init. Cmd Word 4 Register
		Master 8259 OCW1 Op Ctrl Word 1 Register
A0h	A4h, A8h, ACh, B0h, B4h, B8h, BCh	Slave 8259 ICW1 Init. Cmd Word 1 Register
		Slave 8259 OCW2 Op Ctrl Word 2 Register
		Slave 8259 OCW3 Op Ctrl Word 3 Register
A1h	A5h, A9h, ADh, B1h, B5h, B9h, BDh	Slave 8259 ICW2 Init. Cmd Word 2 Register
		Slave 8259 ICW3 Init. Cmd Word 3 Register
		Slave 8259 ICW4 Init. Cmd Word 4 Register
		Slave 8259 OCW1 Op Ctrl Word 1 Register
4D0h	-	Master 8259 Edge/Level Triggered Register
4D1h	-	Slave 8259 Edge/Level Triggered Register

11.3.2.1 Offset 20h, A0h: ICW1 – Initialization Command Word 1

A write to Initialization Command Word 1 starts the interrupt controller initialization sequence, during which the following occurs:

- The Interrupt Mask register is cleared.
- IRQ7 input is assigned priority 7.
- The slave mode address is set to 7.
- Special Mask Mode is cleared and Status Read is set to IRR.

Once this write occurs, the controller expects writes to ICW2, ICW3, and ICW4 to complete the initialization sequence.

Table 314. 20h, A0h: ICW1 – Initialization Command Word 1 (Sheet 1 of 2)

Size: 8 bit		Default:		Power Well: Core
Access		PCI Configuration		B:D:F
Bit Range	Default	Access	Acronym	Description
07 : 05	Undef	WO		These bits are MCS-85 specific, and not needed. Should be programmed to "000"
04	Undef	WO		ICW/OCW select: This bit must be a 1 to select ICW1 and enable the ICW2, ICW3, and ICW4 sequence.

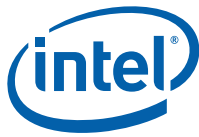

Table 314. 20h, A0h: ICW1 – Initialization Command Word 1 (Sheet 2 of 2)

Size: 8 bit		Default:		Power Well: Core
Access		PCI Configuration		B:D:F
Offset Start: 20h, A0h		Offset End:		
Bit Range	Default	Access	Acronym	Description
03	Undef	WO	LTIM	Edge/Level Bank Select: Disabled. Replaced by ELCR1 and ELCR2.
02	Undef	WO		Reserved, set to 0.
01	Undef	WO	SNGL	Single or Cascade: Must be programmed to a 0 to indicate two controllers operating in cascade mode.
00	Undef	WO	IC4	w/ICW4 Write Required: This bit must be programmed to a 1 to indicate that ICW4 needs to be programmed.

11.3.2.2 Offset 21h, A1h: ICW2 – Initialization Command Word 2

ICW2 is used to initialize the interrupt controller with the five most significant bits of the interrupt vector address. The value programmed for bits[7:3] is used by the CPU to define the base address in the interrupt vector table for the interrupt routines associated with each IRQ on the controller. Typical ISA ICW2 values are 08h for the master controller and 70h for the slave controller.

Table 315. 21h, A1h: ICW2 – Initialization Command Word 2

Size: 8 bit		Default:		Power Well: Core																											
Access		PCI Configuration		B:D:F																											
Offset Start: 21h, A1h		Offset End:																													
Bit Range	Default	Access	Acronym	Description																											
07 : 03	Undef	WO		Interrupt Vector Base Address: Bits [7:3] define the base address in the interrupt vector table for the interrupt routines associated with each interrupt request level input.																											
02 : 00	Undef	WO		<p>Interrupt Request Level: When writing ICW2, these bits should all be 0. During an interrupt acknowledge cycle, these bits are programmed by the interrupt controller with the interrupt to be serviced. This is combined with bits [7:3] to form the interrupt vector driven onto the data bus during the second INTA# cycle. The code is a three bit binary code:</p> <table border="1" style="margin-left: 40px;"> <thead> <tr> <th>Code</th> <th>Master Interrupt</th> <th>Slave Interrupt</th> </tr> </thead> <tbody> <tr><td>000</td><td>IRQ0</td><td>IRQ8</td></tr> <tr><td>001</td><td>IRQ1</td><td>IRQ9</td></tr> <tr><td>010</td><td>IRQ2</td><td>IRQ10</td></tr> <tr><td>011</td><td>IRQ3</td><td>IRQ11</td></tr> <tr><td>100</td><td>IRQ4</td><td>IRQ12</td></tr> <tr><td>101</td><td>IRQ5</td><td>IRQ13</td></tr> <tr><td>110</td><td>IRQ6</td><td>IRQ14</td></tr> <tr><td>111</td><td>IRQ7</td><td>IRQ15</td></tr> </tbody> </table>	Code	Master Interrupt	Slave Interrupt	000	IRQ0	IRQ8	001	IRQ1	IRQ9	010	IRQ2	IRQ10	011	IRQ3	IRQ11	100	IRQ4	IRQ12	101	IRQ5	IRQ13	110	IRQ6	IRQ14	111	IRQ7	IRQ15
Code	Master Interrupt	Slave Interrupt																													
000	IRQ0	IRQ8																													
001	IRQ1	IRQ9																													
010	IRQ2	IRQ10																													
011	IRQ3	IRQ11																													
100	IRQ4	IRQ12																													
101	IRQ5	IRQ13																													
110	IRQ6	IRQ14																													
111	IRQ7	IRQ15																													

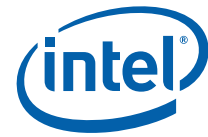

11.3.2.3 Offset 21h: MICW3 – Master Initialization Command Word 3

Table 316. 21h: MICW3 – Master Initialization Command Word 3

Size: 8 bit		Default:		Power Well: Core
Access		PCI Configuration B:D:F		Offset Start: 21h Offset End:
Bit Range	Default	Access	Acronym	Description
07 : 03	Undef	WO		These bits must be programmed to zero.
02	Undef	WO	CCC	Cascaded Controller Connection: This bit must always be programmed to a 1 to indicate the slave controller for interrupts 8-15 is cascaded on IRQ2.
01 : 00	Undef	WO		These bits must be programmed to zero.

11.3.2.4 Offset A1h: SICW3 – Slave Initialization Command Word 3

Table 317. A1h: SICW3 – Slave Initialization Command Word 3

Size: 8 bit		Default:		Power Well: Core
Access		PCI Configuration B:D:F		Offset Start: A1h Offset End:
Bit Range	Default	Access	Acronym	Description
07 : 03	X	WO	RSVD	Reserved. Must be 0.
02 : 00	0	WO		Slave Identification Code: This field must be programmed to 02h to match the code broadcast by the master controller during the INTA# sequence.

11.3.2.5 Offset 21h, A1h: ICW4 – Initialization Command Word 4 Register

Table 318. 21h, A1h: ICW4 – Initialization Command Word 4 Register

Size: 8 bit		Default:		Power Well: Core
Access		PCI Configuration B:D:F		Offset Start: 21h, A1h Offset End:
Bit Range	Default	Access	Acronym	Description
07 : 05	0	WO	RSVD	Reserved. Must be 0.
04	0	WO	SFNM	Special Fully Nested Mode: Should normally be disabled by writing a 0 to this bit. If SFNM=1, the special fully nested mode is programmed.
03	0	WO	BUF	Buffered Mode: Must be cleared for non-buffered mode. Writing '1' will result in undefined behavior.
02	0	WO	MSBM	Master/Slave in Buffered Mode: Not used. Should always be programmed to 0.
01	0	WO	AEOI	Automatic End of Interrupt: This bit should normally be programmed to 0. This is the normal end of interrupt. If this bit is 1, the automatic end of interrupt mode is programmed.
00	1	WO	MM	Microprocessor Mode: This bit must be written to 1 to indicate that the controller is operating in an Intel® architecture-based system. Writing 0 will result in undefined behavior.



11.3.2.6 Offset 21h, A1h: OCW1 – Operational Control Word 1 (Interrupt Mask)

Table 319. 21h, A1h: OCW1 – Operational Control Word 1 (Interrupt Mask)

Size: 8 bit		Default:		Power Well: Core
Access		PCI Configuration B:D:F		Offset Start: 21h, A1h Offset End:
Bit Range	Default	Access	Acronym	Description
07 : 00	00h	RW	IRM	Interrupt Request Mask: When a 1 is written to any bit in this register, the corresponding IRQ line is masked. When a 0 is written to any bit in this register, the corresponding IRQ mask bit is cleared, and interrupt requests will again be accepted by the controller. Masking IRQ2 on the master controller will also mask the interrupt requests from the slave controller.

11.3.2.7 Offset 20h, A0h: OCW2 – Operational Control Word 2

Following a part reset or ICW initialization, the controller enters the fully nested mode of operation. Non-specific EOI without rotation is the default. Both rotation mode and specific EOI mode are disabled following initialization.

Table 320. 20h, A0h: OCW2 – Operational Control Word 2

Size: 8 bit		Default:		Power Well: Core																				
Access		PCI Configuration B:D:F		Offset Start: 20h, A0h Offset End:																				
Bit Range	Default	Access	Acronym	Description																				
07 : 05	001	WO		Rotate and EOI Codes: R, SL, EOI - These three bits control the Rotate and End of Interrupt modes and combinations of the two. 000 - Rotate in Auto EOI Mode (Clear) 001 - Non-specific EOI command 010 - No Operation 011 - Specific EOI Command 100 - Rotate in Auto EOI Mode (Set) 101 - Rotate on Non-Specific EOI Command 110 - Set Priority Command 111 - Rotate on Specific EOI Command ↑L0 - L2 Are Used																				
04 : 03	Undef	WO		OCW2 Select: When selecting OCW2, bits 4:3 = "00"																				
02 : 00	Undef	WO	L2, L1, L0	Interrupt Level Select: L2, L1, and L0 determine the interrupt level acted upon when the SL bit is active. A simple binary code selects the channel for the command to act upon. When the SL bit is inactive, these bits do not have a defined function; programming L2, L1 and L0 to 0 is sufficient in this case. <table border="1" style="margin-left: 20px;"> <thead> <tr> <th>Bits</th> <th>Interrupt Level</th> <th>Bits</th> <th>Interrupt Level</th> </tr> </thead> <tbody> <tr> <td>000</td> <td>IRQ0/8</td> <td>100</td> <td>IRQ4/12</td> </tr> <tr> <td>001</td> <td>IRQ1/9</td> <td>101</td> <td>IRQ5/13</td> </tr> <tr> <td>010</td> <td>IRQ2/10</td> <td>110</td> <td>IRQ6/14</td> </tr> <tr> <td>011</td> <td>IRQ3/11</td> <td>111</td> <td>IRQ7/15</td> </tr> </tbody> </table>	Bits	Interrupt Level	Bits	Interrupt Level	000	IRQ0/8	100	IRQ4/12	001	IRQ1/9	101	IRQ5/13	010	IRQ2/10	110	IRQ6/14	011	IRQ3/11	111	IRQ7/15
Bits	Interrupt Level	Bits	Interrupt Level																					
000	IRQ0/8	100	IRQ4/12																					
001	IRQ1/9	101	IRQ5/13																					
010	IRQ2/10	110	IRQ6/14																					
011	IRQ3/11	111	IRQ7/15																					

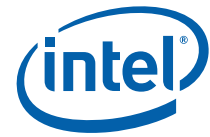

Offset 20h, A0h: OCW3 – Operational Control Word 3

Table 321. 20h, A0h: OCW3 – Operational Control Word 3

Size: 8 bit		Default:		Power Well: Core
Access		PCI Configuration B:D:F		Offset Start: Offset End:
Bit Range	Default	Access	Acronym	Description
07	X	RO	RSVD	Reserved. Must be 0.
06	0	WO	SMM	Special Mask Mode: If this bit is set, the Special Mask Mode can be used by an interrupt service routine to dynamically alter the system priority structure while the routine is executing, through selective enabling/ disabling of the other channel's mask bits. Bit 6, the ESMM bit, must be set for this bit to have any meaning.
05	1	WO	ESMM	Enable Special Mask Mode: When set, the SMM bit is enabled to set or reset the Special Mask Mode. When cleared, the SMM bit becomes a "don't care".
04 : 03	X	WO	O3S	OCW3 Select: When selecting OCW3, bits 4:3 = "01"
02	X	WO	PMC	Poll Mode Command: When cleared, poll command is not issued. When set, the next I/O read to the interrupt controller is treated as an interrupt acknowledge cycle. An encoded byte is driven onto the data bus, representing the highest priority level requesting service.
01 : 00	10	WO	RRC	Register Read Command: These bits provide control for reading the ISR and Interrupt IRR. When bit 1=0, bit 0 will not affect the register read selection. Following ICW initialization, the default OCW3 port address read will be "read IRR". To retain the current selection (read ISR or read IRR), always write a 0 to bit 1 when programming this register. The selected register can be read repeatedly without reprogramming OCW3. To select a new status register, OCW3 must be reprogrammed prior to attempting the read. 00 No Action 01 No Action 10 Read IRQ Register 11 Read IS Register

11.3.2.8 Offset 4D0h: ELCR1 – Master Edge/Level Control

Table 322. 4D0h: ELCR1 – Master Edge/Level Control

Size: 8 bit		Default:		Power Well: Core
Access		PCI Configuration B:D:F		Offset Start: Offset End:
Bit Range	Default	Access	Acronym	Description
07 : 03	0	RW	ECL[7:3]	Edge Level Control: In edge mode, (bit cleared), the interrupt is recognized by a low to high transition. In level mode (bit set), the interrupt is recognized by a high level.
02 : 00	0	RO	RSVD	Reserved. The cascade channel, IRQ2, heart beat timer (IRQ0), and keyboard controller (IRQ1), cannot be put into level mode.



11.3.2.9 Offset 4D1h: ELCR2 – Slave Edge/Level Control

Table 323. 4D1h: ELCR2 – Slave Edge/Level Control

Size: 8 bit		Default:		Power Well: Core
Access		PCI Configuration B:D:F		Offset Start: 4D1h Offset End:
Bit Range	Default	Access	Acronym	Description
07 :06	0	RW	ECL[15:14]	Edge Level Control: In edge mode, (bit cleared), the interrupt is recognized by a low to high transition. In level mode (bit set), the interrupt is recognized by a high level. Bit 7 applies to IRQ15, and bit 6 to IRQ14.
05	0	RO	RSVD	Reserved. The FERR# (IRQ13), cannot be programmed for level mode.
04 :01	0	RW	ECL[12:9]	Edge Level Control: In edge mode, (bit cleared), the interrupt is recognized by a low to high transition. In level mode (bit set), the interrupt is recognized by a high level. Bit 4 applies to IRQ12, bit 3 to IRQ11, bit 2 to IRQ10, and bit 1 to IRQ9.
00	0	RO	RSVD	Reserved. The Real Time Clock (IRQ8#) cannot be programmed for level mode.

11.3.3 Interrupt Handling

11.3.3.1 Generating

The 8259 interrupt sequence involves three bits, from the IRR, ISR, and IMR, for each interrupt level. These bits are used to determine the interrupt vector returned, and status of any other pending interrupts. These bits are defined as follows:

- **Interrupt Request Register (IRR):** Set on a low to high transition of the interrupt line in edge mode, and by an active high level in level mode.
- **Interrupt Service Register (ISR):** Set, and the corresponding IRR bit cleared, when an interrupt acknowledge cycle is seen, and the vector returned is for that interrupt.
- **Interrupt Mask Register (IMR):** Determines whether an interrupt is masked. Masked interrupts will not generate INTR.

11.3.3.2 Acknowledging

The CPU generates an interrupt acknowledge cycle which is translated into an Interrupt Acknowledge Special Cycle. The 8259 translates this cycle into two internal INTA# pulses expected by the 8259 cores. The 8259 uses the first internal INTA# pulse to freeze the state of the interrupts for priority resolution. On the second INTA# pulse, the master or slave will send the interrupt vector to the processor with the acknowledged interrupt code. This code is based upon bits [7:3] of the corresponding ICW2 register, combined with three bits representing the interrupt within that controller.

**Table 324. Content of Interrupt Vector Byte**

Master, Slave Interrupt	Bits [7:3]	Bits [2:0]
IRQ7,15	ICW2[7:3]	111
IRQ6,14		110
IRQ5,13		101
IRQ4,12		100
IRQ3,11		011
IRQ2,10		010
IRQ1,9		001
IRQ0,8		000

11.3.3.3 Hardware/Software Interrupt Sequence

1. One or more of the Interrupt Request lines (IRQ) are raised high in edge mode, or seen high in level mode, setting the corresponding IRR bit.
2. The 8259 sends INTR active (high) to the CPU if an asserted interrupt is not masked.
3. The CPU acknowledges the INTR and responds with an interrupt acknowledge cycle.
4. Upon observing the special cycle, 8259 converts it into the two cycles that the internal 8259 pair can respond to. Each cycle appears as an interrupt acknowledge pulse on the internal INTA# pin of the cascaded interrupt controllers.
5. Upon receiving the first internally generated INTA# pulse, the highest priority ISR bit is set and the corresponding IRR bit is reset. On the trailing edge of the first pulse, a slave identification code is broadcast internally by the master 8259 to the slave 8259. The slave controller uses these bits to determine if it must respond with an interrupt vector during the second INTA# pulse.
6. Upon receiving the second internally generated INTA# pulse, the 8259 returns the interrupt vector. If no interrupt request is present, the 8259 will return vector 7 from the master controller.
7. This completes the interrupt cycle. In AEOI mode the ISR bit is reset at the end of the second INTA# pulse. Otherwise, the ISR bit remains set until an appropriate EOI command is issued at the end of the interrupt subroutine.

11.3.4 Initialization Command Words (ICW)

Before operation can begin, each 8259 must be initialized. In the Intel® Atom™ Processor E6xx Series, this is a four byte sequence to ICW1, ICW2, ICW3, and ICW4. The address for each 8259 initialization command word is a fixed location in the I/O memory space: 20h for the master controller, and A0h for the slave controller.

11.3.4.1 ICW1

A write to the master or slave controller base address with data bit 4 equal to 1 is interpreted as a write to ICW1. Upon sensing this write, 8259 expects three more byte writes to 21h for the master controller, or A1h for the slave controller to complete the ICW sequence.

A write to ICW1 starts the initialization sequence during which the following automatically occur:

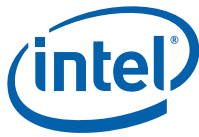

- Following initialization, an interrupt request (IRQ) input must make a low-to-high transition to generate an interrupt.
- The Interrupt Mask Register is cleared.
- IRQ7 input is assigned priority 7.
- The slave mode address is set to 7.
- Special Mask Mode is cleared and Status Read is set to IRR.

11.3.4.2 ICW2

The second write in the sequence, ICW2, is programmed to provide bits [7:3] of the interrupt vector that will be released during an interrupt acknowledge. A different base is selected for each interrupt controller.

11.3.4.3 ICW3

The third write in the sequence, ICW3, has a different meaning for each controller.

- For the master controller, ICW3 is used to indicate which IRQ input line is used to cascade the slave controller. Within the processor, IRQ2 is used. Therefore, bit 2 of ICW3 on the master controller is set to a 1, and the other bits are set to 0's.
- For the slave controller, ICW3 is the slave identification code used during an interrupt acknowledge cycle. On interrupt acknowledge cycles, the master controller broadcasts a code to the slave controller if the cascaded interrupt won arbitration on the master controller. The slave controller compares this identification code to the value stored in its ICW3, and if it matches, the slave controller assumes responsibility for broadcasting the interrupt vector.

11.3.4.4 ICW4

The final write in the sequence, ICW4, must be programmed in both controllers. At the very least, bit 0 must be set to a 1 to indicate that the controllers are operating in an Intel® architecture-based system.

11.3.5 Operation Command Words (OCW)

These command words reprogram the Interrupt Controller to operate in various interrupt modes.

- OCW1 masks and unmask interrupt lines.
- OCW2 controls the rotation of interrupt priorities when in rotating priority mode, and controls the EOI function.
- OCW3 is sets up ISR/IRR reads, enables/disables the Special Mask Mode SMM, and enables/ disables polled interrupt mode.

11.3.6 Modes of Operation

11.3.6.1 Fully Nested Mode

In this mode, interrupt requests are ordered in priority from 0 through 7, with 0 being the highest. When an interrupt is acknowledged, the highest priority request is determined and its vector placed on the bus. Additionally, the ISR for the interrupt is set. This ISR bit remains set until: the CPU issues an EOI command immediately before returning from the service routine; or if in AEIOI mode, on the trailing edge of the second INTA#. While the ISR bit is set, all further interrupts of the same or lower priority are inhibited, while higher levels will generate another interrupt.

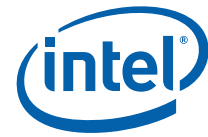

Interrupt priorities can be changed in the rotating priority mode.

11.3.6.2 Special Fully Nested Mode

This mode will be used in the case of a system where cascading is used, and the priority has to be conserved within each slave. In this case, the special fully nested mode will be programmed to the master controller. This mode is similar to the fully nested mode with the following exceptions:

- When an interrupt request from a certain slave is in service, this slave is not locked out from the master's priority logic and further interrupt requests from higher priority interrupts within the slave will be recognized by the master and will initiate interrupts to the processor. In the normal nested mode, a slave is masked out when its request is in service.
- When exiting the Interrupt Service routine, software has to check whether the interrupt serviced was the only one from that slave. This is done by sending a Non-Specific EOI command to the slave and then reading its ISR. If it is 0, a non-specific EOI can also be sent to the master.

11.3.6.3 Automatic Rotation Mode (Equal Priority Devices)

In some applications, there are a number of interrupting devices of equal priority. Automatic rotation mode provides for a sequential 8-way rotation. In this mode, a device receives the lowest priority after being serviced. In the worst case, a device requesting an interrupt will have to wait until each of seven other devices are serviced at most once.

There are two ways to accomplish automatic rotation using OCW2; the Rotation on Non-Specific EOI Command (R=1, SL=0, EOI=1) and the Rotate in Automatic EOI Mode which is set by (R=1, SL=0, EOI=0).

11.3.6.4 Specific Rotation Mode (Specific Priority)

Software can change interrupt priorities by programming the bottom priority. For example, if IRQ5 is programmed as the bottom priority device, then IRQ6 will be the highest priority device. The Set Priority Command is issued in OCW2 to accomplish this, where: R=1, SL=1, and LO-L2 is the binary priority level code of the bottom priority device.

In this mode, internal status is updated by software control during OCW2. However, it is independent of the EOI command. Priority changes can be executed during an EOI command by using the Rotate on Specific EOI Command in OCW2 (R=1, SL=1, EOI=1 and LO-L2=IRQ level to receive bottom priority).

11.3.6.5 Poll Mode

Poll Mode can be used to conserve space in the interrupt vector table. Multiple interrupts that can be serviced by one interrupt service routine do not need separate vectors if the service routine uses the poll command. Polled Mode can also be used to expand the number of interrupts. The polling interrupt service routine can call the appropriate service routine, instead of providing the interrupt vectors in the vector table. In this mode, the INTR output is not used and the microprocessor internal Interrupt Enable flip-flop is reset, disabling its interrupt input. Service to devices is achieved by software using a Poll Command.

The Poll command is issued by setting P=1 in OCW3. The 8259 treats its next I/O read as an interrupt acknowledge, sets the appropriate ISR bit if there is a request, and reads the priority level. Interrupts are frozen from the OCW3 write to the I/O read. The byte returned during the I/O read will contain a '1' in bit 7 if there is an interrupt, and the binary code of the highest priority level in bits 2:0.



11.3.6.6 Edge and Level Triggered Mode

In ISA systems this mode is programmed using bit 3 in ICW1, which sets level or edge for the entire controller. In the processor, this bit is disabled and a new register for edge and level triggered mode selection, per interrupt input, is included. This is the Edge/Level control Registers ELCR1 and ELCR2.

If an ELCR bit is '0', an interrupt request will be recognized by a low to high transition on the corresponding IRQ input. The IRQ input can remain high without generating another interrupt. If an ELCR bit is '1', an interrupt request will be recognized by a high level on the corresponding IRQ input and there is no need for an edge detection. The interrupt request must be removed before the EOI command is issued to prevent a second interrupt from occurring.

In both the edge and level triggered modes, the IRQ inputs must remain active until after the falling edge of the first internal INTA#. If the IRQ input goes inactive before this time, a default IRQ7 vector will be returned.

11.3.7 End Of Interrupt (EOI)

11.3.7.1 Normal EOI

In Normal EOI, software writes an EOI command before leaving the interrupt service routine to mark the interrupt as completed. There are two forms of EOI commands: Specific and Non-Specific. When a Non-Specific EOI command is issued, the 8259 will clear the highest ISR bit of those that are set to 1. Non-Specific EOI is the normal mode of operation of the 8259 within the processor, as the interrupt being serviced currently is the interrupt entered with the interrupt acknowledge. When the 8259 is operated in modes which preserve the fully nested structure, software can determine which ISR bit to clear by issuing a Specific EOI.

An ISR bit that is masked will not be cleared by a Non-Specific EOI if the 8259 is in the Special Mask Mode. An EOI command must be issued for both the master and slave controller.

11.3.7.2 Automatic EOI

In this mode, the 8259 will automatically perform a Non-Specific EOI operation at the trailing edge of the last interrupt acknowledge pulse. From a system standpoint, this mode should be used only when a nested multi-level interrupt structure is not required within a single 8259. The AEIO mode can only be used in the master controller.

11.3.8 Masking Interrupts

11.3.8.1 Masking on an Individual Interrupt Request

Each interrupt request can be masked individually by the Interrupt Mask Register (IMR). This register is programmed through OCW1. Each bit in the IMR masks one interrupt channel. Masking IRQ2 on the master controller will mask all requests for service from the slave controller.

11.3.8.2 Special Mask Mode

Some applications may require an interrupt service routine to dynamically alter the system priority structure during its execution under software control. For example, the routine may wish to inhibit lower priority requests for a portion of its execution but enable some of them for another portion.



The Special Mask Mode enables all interrupts not masked by a bit set in the Mask Register. Normally, when an interrupt service routine acknowledges an interrupt without issuing an EOI to clear the ISR bit, the interrupt controller inhibits all lower priority requests. In the Special Mask Mode, any interrupts may be selectively enabled by loading the Mask Register with the appropriate pattern.

The special Mask Mode is set by OCW3.SSMM and OCW3.SMM set, and cleared when OCW3.SSMM and OCW3.SMM are cleared.

11.3.9 Steering of PCI Interrupts

The processor can be programmed to allow PIRQ[A:H]# to be internally routed to interrupts 3-7, 9-12, 14 or 15, through the PARC, PBRC, PCRC, PDRC, PERC, PFRC, PGRC, and PHRC registers in the chipset configuration section. One or more PIRQx# lines can be routed to the same IRQx# input.

The PIRQx# lines are defined as active low, level sensitive. When PIRQx# is routed to specified IRQ line, software must change the corresponding ELCR1 or ELCR2 register to level sensitive mode. The processor will internally invert the PIRQx# line to send an active high level to the 8259. When a PCI interrupt is routed onto the 8259, the selected IRQ can no longer be used by an ISA device.

11.4 Advanced Peripheral Interrupt Controller (APIC)

11.4.1 Memory Registers

The APIC is accessed via an indirect addressing scheme. These registers are mapped into memory space. The registers are shown below.

Table 325. APIC Registers

Address	Symbol	Register
FEC0000h	IDX	Index Register
FEC00010h	WDW	Window Register
FEC00040h	EOI	EOI Register

11.4.1.1 Address FEC0000h: IDX – Index Register

This 8-bit register selects which indirect register appears in the window register to be manipulated by software. Software will program this register to select the desired APIC internal register.

11.4.1.2 Address FEC00010h: WDW – Window Register

This 32-bit register specifies the data to be read or written to the register pointed to by the IDX register. This register can be accessed only in DW quantities.

11.4.1.3 Address FEC00040h: EOI – EOI Register

When a write is issued to this register, the IOxAPIC will check the lower 8 bits written to this register, and compare it with the vector field for each entry in the I/O Redirection Table. When a match is found, RTE.RIRR for that entry will be cleared. If multiple entries have the same vector, each of those entries will have RTE.RIRR cleared. Only bits 7:0 are used. Bits 31:08 are ignored.



11.4.2 Index Registers

The registers listed below can be accessed via the IDX register. When accessing these registers, accesses must be done as DWs, otherwise unspecified behavior will result. Software should not attempt to write to reserved registers. Some reserved registers may return non-zero values when read.

Table 326. Index Registers

Offset	Symbol	Register
00h	ID	Identification
01h	VS	Version
02-0Fh	-	Reserved
10-11h	RTE0	Redirection Table 0
12-13h	RTE1	Redirection Table 1
...
3E-3Fh	RTE23	Redirection Table 23
40-FFh	-	Reserved

11.4.2.1 Offset 00h: ID – Identification Register

Table 327. 00h: ID – Identification Register

Size: 32 bit		Default:		Power Well: Core
Access		PCI Configuration B:D:F		Offset Start: 00h Offset End: 00h
Bit Range	Default	Access	Acronym	Description
31 : 28	0	RO	RSVD	Reserved
27 : 24	0h	RW	AID	APIC Identification: Software must program this value before using the APIC.
23 : 16	0	RO	RSVD	Reserved
15	0	RW		Scratchpad
14	0	RW	RSVD	Reserved. Writes to this bit have no effect.
13 : 00	0	RO	RSVD	Reserved

11.4.2.2 Offset 01h: VS – Version Register

Table 328. 01h: VS – Version Register (Sheet 1 of 2)

Size: 32 bit		Default:		Power Well: Core
Access		PCI Configuration B:D:F		Offset Start: 01h Offset End: 01h
Bit Range	Default	Access	Acronym	Description
31 : 24	0	RO	RSVD	Reserved
23 : 16	17h	RO	MRE	Maximum Redirection Entries: This is the entry number (0 being the lowest entry) of the highest entry in the redirection table. In the processor this field is hardwired to 17h to indicate 24 interrupts.
15	0	RO	PRQ	Pin Assertion Register Supported: The IOxAPIC does not implement the Pin Assertion Register.



Table 328. 01h: VS – Version Register (Sheet 2 of 2)

Size: 32 bit		Default:		Power Well: Core
Access		PCI Configuration B:D:F		Offset Start: 01h Offset End: 01h
Bit Range	Default	Access	Acronym	Description
14 : 08	0	RO	RSVD	Reserved
07 : 00	20h	RO	VS	Version: Identifies the implementation version as IOxAPIC.

11.4.2.3 Offset 10-11h – 3E-3Fh: RTE[0-23] – Redirection Table Entry

Offset: vector 0: 10h-11h, vector 1: 12h-13h, vector 23: 3Eh-3Fh; vector N: (10h+ (Nx2 in Hex)) - (11h + (Nx2 in Hex)).

Table 329. 10-11h – 3E-3Fh: RTE[0-23] – Redirection Table Entry

Size: 64 bit		Default:		Power Well: Core
Access		PCI Configuration B:D:F		Offset Start: 10h Offset End: 11h
Bit Range	Default	Access	Acronym	Description
63 : 56	X	RW	DID	Destination ID: Destination ID of the local APIC.
55 : 48	X	RW	EDID	Extended Destination ID: Extended destination ID of the local APIC.
47 : 17	0	RO	RSVD	Reserved
16	1	RW	MSK	Mask: When set, interrupts are not delivered nor held pending. When cleared, and edge or level on this interrupt results in the delivery of the interrupt.
15	X	RW	TM	Trigger Mode: When cleared, the interrupt is edge sensitive. When set, the interrupt is level sensitive.
14	X	RW	RIRR	Remote IRR: This is used for level triggered interrupts its meaning is undefined for edge triggered interrupts. This bit is set when IOxAPIC sends the level interrupt message to the CPU. This bit is cleared when an EOI message is received that matches the VCT field. This bit is never set for SMI, NMI, INIT, or ExtINT delivery modes.
13	X	RW	POL	Polarity: This specifies the polarity of each interrupt input. When cleared, the signal is active high. When set, the signal is active low.
12	X	RO	DS	Delivery Status: This field contains the current status of the delivery of this interrupt. When set, an interrupt is pending and not yet delivered. When cleared, there is no activity for this entry
11	X	RW	DSM	Destination Mode: This field is used by the local APIC to determine whether it is the destination of the message.
10 : 08	X	RW	DLM	Delivery Mode: This field specifies how the APICs listed in the destination field should act upon reception of this signal. Certain Delivery Modes will only operate as intended when used in conjunction with a specific trigger mode. These encodings are: 000 Fixed 001 Lowest Priority 010 SMI – Not supported. 011 Reserved 100 NMI – Not supported. 101 INIT – Not supported. 110 Reserved 111 ExtINT
07 : 00	X	RW	VCT	Vector: This field contains the interrupt vector for this interrupt. Values range between 10h and FEh.



11.4.3 Unsupported Modes

These delivery modes are not supported for the following reasons:

- **NMI / INIT:** This cannot be delivered while the CPU is in the Stop Grant state. In addition, this is a break event for power management.
- **SMI:** There is no way to block the delivery of the SMI#, except through BIOS.
- **Virtual Wire Mode B:** The processor does not support the INTR of the 8259 routed to the I/OxAPIC pin 0.

11.4.4 Interrupt Delivery

11.4.4.1 Theory of Operation

Delivery of interrupts is done by writing to a fixed set of memory locations in CPU(s).

The following sequence is used:

- When the processor detects an interrupt event (active edge for edge-triggered mode or a change for level-triggered mode), it sets or resets the internal IRR bit associated with that interrupt.
- The processor delivers the message by performing a write cycle to the appropriate address with the appropriate data. The address and data formats are described in section below.

11.4.4.2 EOI

The data of the EOI message is the vector. This value is compared with all the vectors inside the IOxAPIC, and any match causes RTE[x].RIRR to be cleared. The EOI is a downstream 32-bit memory write cycle (with byte0 enabled) sent from CPU to IOxAPIC.

11.4.4.3 Interrupt Message Format

The processor writes the message to the backbone as a 32-bit memory write cycle. It uses the following formats the Address and Data:

11.4.4.4 Interrupt Delivery Address Value

Table 330. Interrupt Delivery Address Value

Bit	Description
31:20	FEEh
19:12	Destination ID: RTE[x].DID
11:04	Extended Destination ID: RTE[x].EDID
03	Redirection Hint: If RTE[x].DLM = "Lowest Priority" (001), this bit will be set. Otherwise, this bit will be cleared.
02	Destination Mode: RTE[x].DSM
01:00	00



11.4.4.5 Interrupt Delivery Data Value

Table 331. Interrupt Delivery Data Value

Bit	Description
31:16	0000h
15	Trigger Mode: RTE[x].TM
14	Delivery Status: 1 = Assert, 0 = Deassert. Only Assert messages are sent. This bit is always set to '1'.
13:12	00
11	Destination Mode: RTE[x].DSM
10:08	Delivery Mode: RTE[x].DLM
07:00	Vector: RTE[x].VCT

11.4.5 PCI Express* Interrupts

When external devices through PCI Express* generate an interrupt, they will send the message defined in the PCI Express* specification for generating INTA# - INTD#. These will be translated internal assertions/de-assertions of INTA# - INTD#.

11.4.6 Routing of Internal Device Interrupts

The internal devices on the processor drive PCI interrupts. These interrupts can be routed internally to any of PIRQA# - PIRQH#. This is done utilizing the “Device X Interrupt Pin” and “Device X Interrupt Route” registers located in chipset configuration space.

For each device, the “Device X Interrupt Pin” register exists which tells the functions which interrupt to report in their PCI header space, in the “Interrupt Pin” register, for the operating system. These registers are named D24IP, D23IP, D02IP, etc.

Additionally, the “Device X Interrupt Route” register tells the interrupt controller, in conjunction with the “Device X Interrupt Pin” register, which of the internal PIRQA# - PIRQH# to drive the devices interrupt onto. This requires the interrupt controller to know which function each device is connected to.

11.5 Serial Interrupt

11.5.1 Overview

The interrupt controller supports a serial IRQ scheme. The signal used to transmit this information is shared between the interrupt controller and all peripherals that support serial interrupts. The signal line, SERIRQ, is synchronous to LPC clock, and follows the sustained tristate protocol that is used by LPC signals. The serial IRQ protocol defines this sustained tristate signaling in the following fashion:

- **S - Sample Phase:** Signal driven low
- **R - Recovery Phase:** Signal driven high
- **T - Turn-around Phase:** Signal released

The interrupt controller supports 21 serial interrupts. These represent the 15 ISA interrupts (IRQ0- 1, 3-15), the four PCI interrupts, and the control signals SMI# and IOCHK#.



- **Start Frame:** SERIRQ line driven low by the interrupt controller to indicate the start of IRQ transmission
- **Data Frames:** IRQ information transmitted by peripherals. The interrupt controller supports 21 data frames.
- **Stop Frame:** SERIRQ line driven low by the interrupt controller to indicate end of transmission and next mode of operation.

11.5.2 Start Frame

The serial IRQ protocol has two modes of operation which affect the start frame:

- **Continuous Mode:** The interrupt controller is solely responsible for generating the start frame
- **Quiet Mode:** Peripheral initiates the start frame, and the interrupt controller completes it.

These modes are entered via the length of the stop frame.

Continuous mode must be entered first, to start the first frame. This start frame width is 8 LPC clocks. This is a polling mode.

In Quiet mode, the SERIRQ line remains inactive and pulled up between the Stop and Start Frame until a peripheral drives SERIRQ low. The interrupt controller senses the line low and drives it low for the remainder of the Start Frame. Since the first LPC clock of the start frame was driven by the peripheral, the interrupt controller drives SERIRQ low for 1 LPC clock less than in continuous mode. This mode of operation allows for lower power operation.

11.5.3 Data Frames

Once the Start frame has been initiated, the SERIRQ peripherals start counting frames based on the rising edge of SERIRQ. Each of the IRQ/DATA frames has exactly 3 phases of 1 clock each:

- **Sample Phase:** During this phase, a device drives SERIRQ low if its corresponding interrupt signal is low. If its corresponding interrupt is high, then the SERIRQ devices tristate SERIRQ. SERIRQ remains high due to pull-up resistors.
- **Recovery Phase:** During this phase, a device drives SERIRQ high if it was driven low during the Sample Phase. If it was not driven during the sample phase, it remains tristated in this phase.
- **Turn-around Phase:** The device tristates SERIRQ.

11.5.4 Stop Frame

After the data frames, a Stop Frame will be driven by the interrupt controller. SERIRQ will be driven low for 2 or 3 LPC clocks. The number of clocks is determined by the SCNT.MD field in D31:F0 configuration space. The number of clocks determines the next mode:

Table 332. Serial Interrupt Mode Selection

Stop Frame Width	Next Mode
2 LPC clocks	Quiet Mode: Any SERIRQ device initiates a Start Frame
3 LPC clocks	Continuous Mode: Only the interrupt controller initiates a Start Frame

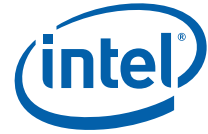

11.5.5 Serial Interrupts Not Supported

There are 4 interrupts on the serial stream which are not supported by the interrupt controller. These interrupts are generated internally, and are not sharable with other devices within the system. These interrupts are:

- IRQ0: Heartbeat interrupt generated off of the internal 8254 counter 0.
- IRQ8#: RTC interrupt can only be generated internally.
- IRQ13: This interrupt (floating point error) is not supported in the processor.
- IRQ14: PATA interrupt can only be generated from the external P-Device.

The interrupt controller will ignore the state of these interrupts in the stream.

11.5.6 Data Frame Format and Issues

Table 333 shows the format of the data frames. The decoded INT[A:D]# values are ANDed with the corresponding PCI Express* input signals (PIRQ[A:D]#). This way, the interrupt can be shared.

The other interrupts decoded via SERIRQ are also ANDed with the corresponding internal interrupts. For example, if IRQ10 is set to be used as the SCI, then it is ANDed with the decoded value for IRQ10 from the SERIRQ stream.

Table 333. Data Frame Format

Data Frame #	Interrupt	Clocks Past Start Frame	Comment
1	IRQ0	2	Ignored. Can only be generated via the internal 8254
2	IRQ1	5	Before port 60h latch
3	SMI#	8	Causes SMI# if low. Sets bit 15 in the SMI_STS register
4	IRQ3	11	
5	IRQ4	14	
6	IRQ5	17	
7	IRQ6	20	
8	IRQ7	23	
9	IRQ8	26	Ignored. IRQ8# can only be generated internally
10	IRQ9	29	
11	IRQ10	32	
12	IRQ11	35	
13	IRQ12	38	Before port 60h latch
14	IRQ13	41	Ignored.
15	IRQ14	44	Ignored
16	IRQ15	47	
17	IOCHCK#	50	Same as ISA IOCHCK# going active.
18	PCI INTA#	53	
19	PCI INTB#	56	
20	PCI INTC#	59	
21	PCI INTD#	62	

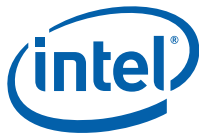

11.6 Real Time Clock

11.6.1 Overview

The Real Time Clock (RTC) module provides a battery backed-up date and time keeping device. Three interrupt features are available: time of day alarm with once a second to once a month range, periodic rates of 122 μ s to 500 ms, and end of update cycle notification. Seconds, minutes, hours, days, day of week, month, and year are counted. The hour is represented in twelve or twenty-four hour format, and data can be represented in BCD or binary format. The design is meant to be functionally compatible with the Motorola MS146818B. The time keeping comes from a 32.768 kHz oscillating source, which is divided to achieve an update every second. The lower 14 bytes on the lower RAM block have very specific functions. The first ten are for time and date information. The next four (0Ah to 0Dh) are registers, which configure and report RTC functions. A host-initiated write takes precedence over a hardware update in the event of a collision.

11.6.2 I/O Registers

The RTC internal registers and RAM are organized as two banks of 128 bytes each, called the standard and extended banks. The first 14 bytes of the standard bank contain the RTC time and date information along with four registers, A - D, that are used for configuration of the RTC. The extended bank contains a full 128 bytes of battery backed SRAM. All data movement between the host CPU and the RTC is done through registers mapped to the standard I/O space. The register map appears below.

Table 334. RTC Registers

I/O Locations	If U128E bit = 0	Function
70h and 74h	Also alias to 72h and 76h	Real-Time Clock (Standard RAM) Index Register
71h and 75h	Also alias to 73h and 77h	Real-Time Clock (Standard RAM) Target Register
72h and 76h		Extended RAM Index Register (if enabled)
73h and 77h		Extended RAM Target Register (if enabled)

Notes:

1. I/O locations 70h and 71h are the standard ISA location for the real-time clock. Locations 72h and 73h are for accessing the extended RAM. The extended RAM bank is also accessed using an indexed scheme. I/O address 72h is used as the address pointer and I/O address 73h is used as the data register. Index addresses above 127h are not valid.
2. Writes to 72h, 74h, and 76h do not affect the NMI enable (bit 7 of 70h).

Note: Port 70h is not directly readable. The only way to read this register is through Alt Access mode. Although RTC Index bits 6:0 are readable from port 74h, bit 7 will always return 0. If the NMI# enable is not changed during normal operation, software can alternatively read this bit once and then retain the value for all subsequent writes to port 70h.

11.6.3 Indexed Registers

The RTC contains two sets of indexed registers that are accessed using the two separate Index and Target registers (70/71h or 72/73h), as shown below.



Table 335. RTC Indexed Registers

Start	End	Name
00h	00h	Seconds
01h	01h	Seconds Alarm
02h	02h	Minutes
03h	03h	Minutes Alarm
04h	04h	Hours
05h	05h	Hours Alarm
06h	06h	Day of Week
07h	07h	Day of Month
08h	08h	Month
09h	09h	Year
0Ah	0Ah	Register A
0Bh	0Bh	Register B
0Ch	0Ch	Register C
0Dh	0Dh	Register D
0Eh	7Fh	114 Bytes of User RAM

11.6.3.1 Offset 0Ah: Register A

This register is in the RTC well, and is used for general configuration of the RTC functions. None of the bits are affected by RSMRST# or any other reset signal.

Table 336. 0Ah: Register A (Sheet 1 of 2)

Size: 8 bit		Default:		Power Well: RTC			
Access		PCI Configuration B:D:F		Offset Start: 0Ah Offset End: 0Ah			
Bit Range	Default	Access	Acronym	Description			
07	Undef	RW	UIP	Update in progress: When set, an update is in progress. When cleared, the update cycle will not start for at least 488 μ s. The time, calendar, and alarm information in RAM is always available when this bit is cleared.			
06 : 04	Undef	RW	DV	Division Chain Select: Controls the divider chain for the oscillator, and are not affected by RSMRST# or any other reset signal.			
				0h	Invalid	4h	Bypass 10 stages (test mode only)
				1h	Invalid	5h	Bypass 15 stages (test mode only)
				2h	Normal Operation	6h	Divider Reset
				3h	Bypass 5 stages (test mode only)	7h	Divider Reset

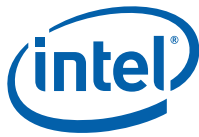

Table 336. 0Ah: Register A (Sheet 2 of 2)

Size: 8 bit		Default:		Power Well: RTC																																				
Access		PCI Configuration		Offset Start: 0Ah Offset End: 0Ah																																				
		B:D:F																																						
Bit Range	Default	Access	Acronym	Description																																				
03:00	Undef	RW	RS	<p>Rate Select: Selects one of 13 taps of the 15 stage divider chain. The selected tap can generate a periodic interrupt if B.PIE bit is set. Otherwise this tap will set C.PF.</p> <table border="1"> <thead> <tr> <th>Bits</th> <th>Function</th> <th>Bits</th> <th>Function</th> </tr> </thead> <tbody> <tr> <td>0h</td> <td>Interrupt never toggles</td> <td>8h</td> <td>3.90625 ms</td> </tr> <tr> <td>1h</td> <td>3.90625 ms</td> <td>9h</td> <td>7.8125 ms</td> </tr> <tr> <td>2h</td> <td>7.8125 ms</td> <td>Ah</td> <td>15.625 ms</td> </tr> <tr> <td>3h</td> <td>122.070 μs</td> <td>Bh</td> <td>31.25 ms</td> </tr> <tr> <td>4h</td> <td>244.141 μs</td> <td>Ch</td> <td>62.5 ms</td> </tr> <tr> <td>5h</td> <td>488.281 μs</td> <td>Dh</td> <td>125 ms</td> </tr> <tr> <td>6h</td> <td>976.5625 μs</td> <td>Eh</td> <td>250 ms</td> </tr> <tr> <td>7h</td> <td>1.953125 ms</td> <td>Fh</td> <td>500 ms</td> </tr> </tbody> </table>	Bits	Function	Bits	Function	0h	Interrupt never toggles	8h	3.90625 ms	1h	3.90625 ms	9h	7.8125 ms	2h	7.8125 ms	Ah	15.625 ms	3h	122.070 μs	Bh	31.25 ms	4h	244.141 μs	Ch	62.5 ms	5h	488.281 μs	Dh	125 ms	6h	976.5625 μs	Eh	250 ms	7h	1.953125 ms	Fh	500 ms
Bits	Function	Bits	Function																																					
0h	Interrupt never toggles	8h	3.90625 ms																																					
1h	3.90625 ms	9h	7.8125 ms																																					
2h	7.8125 ms	Ah	15.625 ms																																					
3h	122.070 μs	Bh	31.25 ms																																					
4h	244.141 μs	Ch	62.5 ms																																					
5h	488.281 μs	Dh	125 ms																																					
6h	976.5625 μs	Eh	250 ms																																					
7h	1.953125 ms	Fh	500 ms																																					

11.6.3.2 Offset 0Bh: Register B - General Configuration

This register resides in the RTC well. Bits are reset by RSMRST#.

Table 337. 0Bh: Register B - General Configuration

Size: 8 bit		Default:		Power Well: RTC
Access		PCI Configuration		Offset Start: 0Bh Offset End: 0Bh
		B:D:F		
Bit Range	Default	Access	Acronym	Description
07	Undef	RW	SET	Update Cycle Inhibit: When cleared, an update cycle occurs once each second. If set, a current update cycle will abort and subsequent update cycles will not occur until SET is returned to zero. When set, SW may initialize time and calendar bytes safely.
06	0	RW	PIE	Periodic Interrupt Enable: When set, and C.PF is set, an interrupt is generated.
05	Undef	RW	AIE	Alarm Interrupt Enable: When set, and C.AF is set, an interrupt is generated.
04	0	RW	UIE	Update-ended Interrupt Enable: When set and C.UF is set, an interrupt is generated.
03	0	RW	SQWE	Square Wave Enable: Not implemented.
02	Undef	RW	DM	Data Mode: When set, represents binary representation. When cleared, denotes BCD.
01	Undef	RW	HF	Hour Format: When set, twenty-four hour mode is selected. When cleared, twelve-hour mode is selected. In twelve hour mode, the seventh bit represents AM (cleared) and PM (set).
00	Undef	RW	DSE	Daylight Savings Enable: Not implemented

11.6.3.3 Offset 0Ch: Register C - Flag Register (RTC Well)

All bits in this register are cleared when this register is read. This register is cleared upon RSMRST#.

**Table 338. 0Ch: Register C - Flag Register**

Size: 8 bit		Default:		Power Well: RTC
Access		PCI Configuration B:D:F		Offset Start: 0Ch Offset End: 0Ch
Bit Range	Default	Access	Acronym	Description
07	0	RO	IRQF	Interrupt Request Flag: This bit is an AND of the flag with its corresponding interrupt enable in register B, and causes the RTC Interrupt to be asserted.
06	0	RO	PF	Periodic Interrupt Flag: Set when the tap as specified by A.RS is one.
05	Undef	RO	AF	Alarm Flag: Set after all Alarm values match the current time.
04	0	RO	UF	Update-ended Flag: Set immediately following an update cycle for each second.
03 : 00	0	RO	RSVD	Reserved

11.6.3.4 Offset 0Dh: Register D - Flag Register (RTC Well)

Table 339. 0Dh: Register D - Flag Register (RTC Well)

Size: 8 bit		Default:		Power Well: RTC
Access		PCI Configuration B:D:F		Offset Start: 0Dh Offset End: 0Dh
Bit Range	Default	Access	Acronym	Description
07	1	RW	VRT	Valid RAM and Time Bit: This bit should always be written as a 0 for write cycle, however it will return a 1 for read cycles.
06	X	RW	RSVD	Reserved: This bit always returns a 0 and should be set to 0 for write cycles.
05 : 00	X	RW	DA	Date Alarm: These bits store the date of month alarm value. If set to 000000, then a don't care state is assumed. If the date alarm is not enabled, these bits will return zeros to mimic the functionality of the Motorola 146818B. These bits are not affected by any reset assertion.

11.6.4 Update Cycles

An update cycle occurs once a second, if B.SET bit is not asserted and the divide chain is properly configured. During this procedure, the stored time and date will be incremented, overflow will be checked, a matching alarm condition will be checked, and the time and date will be rewritten to the RAM locations. The update cycle will start at least 488µs after A.UIP is asserted, and the entire cycle will not take more than 1984µs to complete. The time and date RAM locations (0-9) will be disconnected from the external bus during this time.

11.6.5 Interrupts

The RTC interrupt is internally routed to interrupt 8, and is not it shared with any other interrupt. IRQ8# from SERIRQ is ignored. The HPET can also be mapped to IRQ8#; in this case, the RTC interrupt is blocked.



11.7 General Purpose I/O

11.7.1 Core Well GPIO I/O Registers

The control for the general purpose I/O signals is handled through an independent 64-byte I/O space. The base offset for this space is selected by the GPIO_BAR register in D31:F0 config space.

Note: the Core Well GPIO registers are mapped to the “GPIO” pins and the resume well are mapped to the GPIO_SUS[n] pins.

Table 340. GPIO I/O Register

Start	End	Name
00	03	CGEN – Core Well GPIO Enable
04	07	CGIO – Core Well GPIO Input/Output Select
08	0B	CGLV – Core Well GPIO Level for Input or Output
0C	0F	CGTPE – Core Well GPIO Trigger Positive Edge Enable
10	13	CGTNE – Core Well GPIO Trigger Negative Edge Enable
14	17	CGGPE – Core Well GPIO GPE Enable
18	1B	CGSMI – Core Well GPIO SMI Enable
1C	1F	CGTS – Core Well GPIO Trigger Status

If a bit is allocated for a GPIO that doesn’t exist, unless otherwise indicated, the bit will always read as 0 and values written to that bit will have no effect.

All core well bits are reset by the standard conditions that assert RESET#, and all suspend well bits are reset by the standard conditions that clear internal suspend registers.

11.7.1.1 Offset 00h: CGEN – Core Well GPIO Enable

Table 341. 00h: CGEN – Core Well GPIO Enable

Size: 32 bit		Default: 0000001Fh		Power Well: Core
Access		PCI Configuration	B:D:F 0:31:0	Offset Start: 00h Offset End: 03h
		Memory Mapped IO	BAR: GPIO_BAR (IO)	Offset:
Bit Range	Default	Access	Acronym	Description
31 : 05	0	RO	RSVD	Reserved
04 : 00	1Fh	RW	EN	Enable: When set, enables the pin as a GPIO. When cleared, the pin, if muxed, returns to its normal use. This field has no effect on unmuxed GPIOs. Bits 4:0 muxed between GPIO[4:0]



11.7.1.2 Offset 04h: CGIO – Core Well GPIO Input/Output Select

Table 342. 04h: CGIO – Core Well GPIO Input/Output Select

Size: 32 bit		Default: 0000001Fh		Power Well: Core
Access	PCI Configuration		B:D:F 0:31:0	Offset Start: 04h Offset End: 07h
	Memory Mapped IO		BAR: GPIO_BAR (IO)	Offset:
Bit Range	Default	Access	Acronym	Description
31 : 05	0	RO	RSVD	Reserved
04 : 00	1Fh	RW	IO	Input/Output: When set, the GPIO signal (if enabled) is programmed as an input. When cleared, the GPIO signal is programmed as an output. If the pin is muxed, and not enabled, writes to these bits have no effect.

11.7.1.3 Offset 08h: CGLVL – Core Well GPIO Level for Input or Output

Table 343. 08h: CGLVL – Core Well GPIO Level for Input or Output

Size: 32 bit		Default: 00000000h		Power Well: Core
Access	PCI Configuration		B:D:F 0:31:0	Offset Start: 08h Offset End: 0Bh
	Memory Mapped IO		BAR: GPIO_BAR (IO)	Offset:
Bit Range	Default	Access	Acronym	Description
31 : 05	0	RO	RSVD	Reserved
04 : 00	0	RW	LVL	Level: If the GPIO is programmed to be an output (GIO.IO[n] cleared), then this bit is used by software to drive a value on the pin. 1 = high, 0 = low. If the GPIO is programmed as an input, then this bit reflects the state of the input signal (1 = high, 0 = low.) and writes will have no effect. The value of this bit has no meaning if the GPIO is disabled (GEN.EN[n] = '0').

11.7.1.4 Offset 0Ch: CGTPE – Core Well GPIO Trigger Positive Edge Enable

Table 344. 0Ch: CGTPE – Core Well GPIO Trigger Positive Edge Enable

Size: 32 bit		Default: 00000000h		Power Well: Core
Access	PCI Configuration		B:D:F 0:31:0	Offset Start: 0Ch Offset End: 0Fh
	Memory Mapped IO		BAR: GPIO_BAR (IO)	Offset:
Bit Range	Default	Access	Acronym	Description
31 : 05	0	RO	RSVD	Reserved
04 : 00	0	RW	TE	Trigger Enable: When set, the corresponding GPIO, if enabled as input via GIO.IO[n], will cause an SMI#/SCI when a '0' to '1' transition occurs. When cleared, the GPIO is not enabled to trigger an SMI#/SCI on a '0' to '1' transition. This bit has no meaning if GIO.IO[n] is cleared (i.e. programmed for output)



11.7.1.5 Offset 10h: CGTNE – Core Well GPIO Trigger Negative Edge Enable

Table 345. 10h: CGTNE – Core Well GPIO Trigger Negative Edge Enable

Size: 32 bit		Default: 00000000h		Power Well: Core
Access		PCI Configuration B:D:F 0:31:0		Offset Start: 10h Offset End: 13h
		Memory Mapped IO BAR: GPIO_BAR (IO)		Offset:
Bit Range	Default	Access	Acronym	Description
31 : 05	0	RO	RSVD	Reserved
04 : 00	0	RW	TE	Trigger Enable: When set, the corresponding GPIO, if enabled as input via GIO.IO[n], will cause an SMI#/SCI when a '1' to '0' transition occurs. When cleared, the GPIO is not enabled to trigger an SMI#/SCI on a '1' to '0' transition. This bit has no meaning if GIO.IO[n] is cleared (i.e. programmed for output)

11.7.1.6 Offset 14h: CGGPE – Core Well GPIO GPE Enable

Table 346. 14h: CGGPE – Core Well GPIO GPE Enable

Size: 32 bit		Default: 00000000h		Power Well: Core
Access		PCI Configuration B:D:F 0:31:0		Offset Start: 14h Offset End: 17h
		Memory Mapped IO BAR: GPIO_BAR (IO)		Offset:
Bit Range	Default	Access	Acronym	Description
31 : 05	0	RO	RSVD	Reserved
04 : 00	00	RW	EN	Enable: When set, when CGTS.TS[n] is set, the ACPI GPEOS.GPIO bit will be set.

11.7.1.7 Offset 18h: CGSMI – Core Well GPIO SMI Enable

Table 347. 18h: CGSMI – Core Well GPIO SMI Enable

Size: 32 bit		Default: 00000000h		Power Well: Core
Access		PCI Configuration B:D:F 0:31:0		Offset Start: 18h Offset End: 1Bh
		Memory Mapped IO BAR: GPIO_BAR (IO)		Offset:
Bit Range	Default	Access	Acronym	Description
31 : 05	0	RO	RSVD	Reserved
04 : 00	00	RW	EN	Enable: When set, when CGTS.TS[n] is set, the ACPI SMIS.GPIO bit will be set.



11.7.1.8 Offset 1Ch: CGTS – Core Well GPIO Trigger Status

Table 348. 1Ch: CGTS – Core Well GPIO Trigger Status

Size: 32 bit		Default: 00000000h		Power Well: Core
Access	PCI Configuration		B:D:F 0:31:0	Offset Start: 1Ch Offset End: 1Fh
	Memory Mapped IO		BAR: GPIO_BAR (IO)	Offset:
Bit Range	Default	Access	Acronym	Description
31 :05	0	RO	RSVD	Reserved
04 :00	0	RWC	TS	Trigger Status: When set, the corresponding GPIO, if enabled as input via GIO.IO[n], triggered an SMI#/SCI. This will be set if a '0' to '1' transition occurred and GTPE.TE[n] was set, or a '1' to '0' transition occurred and GTNE.TE[n] was set. If both GTPE.TE[n] and GTNE.TE[n] are set, then this bit will be set on both a '0' to '1' and a '1' to '0' transition. This bit will not be set if the GPIO is configured as an output.

11.7.2 Resume Well GPIO I/O Registers

The control for the general purpose I/O signals is handled through an independent 64-byte I/O space. The base offset for this space is selected by the GPIO_BAR register in D31:F0 config space. The total GPIO in resume well is 9.

Table 349. Resume Well GPIO Registers

Start	End	Name
20	23	RGEN – Resume Well GPIO Enable
24	27	RGIO – Resume Well GPIO Input/Output Select
28	2B	RGLV – Resume Well GPIO Level for Input or Output
2C	2F	RGTPE – Resume Well GPIO Trigger Positive Edge Enable
30	33	RGTNE – Resume Well GPIO Trigger Negative Edge Enable
34	37	RGGPE – Resume Well GPIO GPE Enable
38	3B	RGSMI – Resume Well GPIO SMI Enable
3C	3F	RGTS – Resume Well GPIO Trigger Status

The format of these registers is the same as their core well counter parts (see [Section 11.7.1](#)), the difference being these registers live in the resume well (which range bit0 to bit8).

11.7.2.1 Offset 20h: RGEN – Resume Well GPIO Enable

Table 350. 20h: RGEN – Resume Well GPIO Enable (Sheet 1 of 2)

Size: 32 bit		Default: 000001FFh		Power Well: Resume
Access	PCI Configuration		B:D:F 0:31:0	Offset Start: 20h Offset End: 23h
	Memory Mapped IO		BAR: GPIO_BAR (IO)	Offset:
Bit Range	Default	Access	Acronym	Description
31 :09	0	RO	RSVD	Reserved



Table 350. 20h: RGEN – Resume Well GPIO Enable (Sheet 2 of 2)

Size: 32 bit		Default: 000001FFh		Power Well: Resume
Access		PCI Configuration B:D:F 0:31:0		Offset Start: 20h Offset End: 23h
		Memory Mapped IO BAR: GPIO_BAR (IO)		Offset:
Bit Range	Default	Access	Acronym	Description
08 : 00	1FFh	RW	EN	Enable: When set, enables the pin as a GPIO. When cleared, the pin, if muxed, returns to its normal use. This field has no effect on unmuxed GPIOs.

11.7.2.2 Offset 24h: RGIO – Resume Well GPIO Input/Output Select

Table 351. 24h: RGIO – Resume Well GPIO Input/Output Select

Size: 32 bit		Default: 000001FFh		Power Well: Resume
Access		PCI Configuration B:D:F 0:31:0		Offset Start: 24h Offset End: 27h
		Memory Mapped IO BAR: GPIO_BAR (IO)		Offset:
Bit Range	Default	Access	Acronym	Description
31 : 09	0	RO	RSVD	Reserved
08 : 00	1FFh	RW	IO	Input/Output: When set, the GPIO signal (if enabled) is programmed as an input. When cleared, the GPIO signal is programmed as an output. If the pin is muxed, and not enabled, writes to these bits have no effect.

11.7.2.3 Offset 28h: RGLVL – Resume Well GPIO Level for Input or Output

Table 352. 28h: RGLVL – Resume Well GPIO Level for Input or Output

Size: 32 bit		Default: 00000000h		Power Well: Resume
Access		PCI Configuration B:D:F 0:31:0		Offset Start: 28h Offset End: 28h
		Memory Mapped IO BAR: GPIO_BAR (IO)		Offset:
Bit Range	Default	Access	Acronym	Description
31 : 09	0	RO	RSVD	Reserved
08 : 00	0	RW	LVL	Level: If the GPIO is programmed to be an output (RGIO.IO[n] cleared), then this bit is used by software to drive a value on the pin. 1 = high, 0 = low. If the GPIO is programmed as an input, then this bit reflects the state of the input signal (1 = high, 0 = low.) and writes will have no effect. The value of this bit has no meaning if the GPIO is disabled (RGEN.EN[n] = '0').



11.7.2.4 Offset 2Ch: RGTPE – Resume Well GPIO Trigger Positive Edge Enable

Table 353. 2Ch: RGTPE – Resume Well GPIO Trigger Positive Edge Enable

Size: 32 bit		Default: 00000000h		Power Well: Resume
Access		PCI Configuration B:D:F 0:31:0		Offset Start: 2Ch Offset End: 2Fh
		Memory Mapped IO BAR: GPIO_BAR (IO)		Offset:
Bit Range	Default	Access	Acronym	Description
31 : 09	0	RO	RSVD	Reserved
08 : 00	0	RW	TE	Trigger Enable: When set, the corresponding GPIO, if enabled as input via RGIO.IO[n], will cause an SMI#/SCI when a '0' to '1' transition occurs. When cleared, the GPIO is not enabled to trigger an SMI#/SCI on a '0' to '1' transition. This bit has no meaning if GIO.IO[n] is cleared (i.e. programmed for output)

11.7.2.5 Offset 30h: RGTNE – Resume Well GPIO Trigger Negative Edge Enable

Table 354. 30h: RGTNE – Resume Well GPIO Trigger Negative Edge Enable

Size: 32 bit		Default: 00000000h		Power Well: Resume
Access		PCI Configuration B:D:F 0:31:0		Offset Start: 30h Offset End: 33h
		Memory Mapped IO BAR: GPIO_BAR (IO)		Offset:
Bit Range	Default	Access	Acronym	Description
31 : 09	0	RO	RSVD	Reserved
08 : 00	0	RW	TE	Trigger Enable: When set, the corresponding GPIO, if enabled as input via RGIO.IO[n], will cause an SMI#/SCI when a '1' to '0' transition occurs. When cleared, the GPIO is not enabled to trigger an SMI#/SCI on a '1' to '0' transition. This bit has no meaning if RGIO.IO[n] is cleared (i.e. programmed for output)

11.7.2.6 Offset 34h: RGGPE – Resume Well GPIO GPE Enable

Table 355. 34h: RGGPE – Resume Well GPIO GPE Enable

Size: 32 bit		Default: 00000000h		Power Well: Resume
Access		PCI Configuration B:D:F 0:31:0		Offset Start: 34h Offset End: 37h
		Memory Mapped IO BAR: GPIO_BAR (IO)		Offset:
Bit Range	Default	Access	Acronym	Description
31 : 09	0	RO	RSVD	Reserved
08 : 00	00	RW	EN	Enable: When set, when RGTS.TS[n] is set, the ACPI GPEOS.GPIO bit will be set.



11.7.2.7 Offset 38h: RGSMI – Resume Well GPIO SMI Enable

Table 356. 38h: RGSMI – Resume Well GPIO SMI Enable

Size: 32 bit		Default: 00000000h		Power Well: Resume
Access		PCI Configuration B:D:F 0:31:0		Offset Start: 38h Offset End: 3Bh
		Memory Mapped IO BAR: GPIO_BAR (IO)		Offset:
Bit Range	Default	Access	Acronym	Description
31 : 09	0	RO	RSVD	Reserved
08 : 00	00	RW	EN	Enable: When set, when RGTS.TS[n] is set, the ACPI SMIS.GPIO bit will be set.

11.7.2.8 Offset 3Ch: RGTS – Resume Well GPIO Trigger Status

Table 357. 3Ch: RGTS – Resume Well GPIO Trigger Status

Size: 32 bit		Default: 00000000h		Power Well: Resume
Access		PCI Configuration B:D:F 0:31:0		Offset Start: 3Ch Offset End: 3Fh
		Memory Mapped IO BAR: GPIO_BAR (IO)		Offset:
Bit Range	Default	Access	Acronym	Description
31 : 09	0	RO	RSVD	Reserved
08 : 00	0	RWC	TS	Trigger Status: When set, the corresponding GPIO, if enabled as input via RGIO.IO[n], triggered an SMI#/SCI. This will be set if a '0' to '1' transition occurred and RGTP.E.TE[n] was set, or a '1' to '0' transition occurred and RGTNE.TE[n] was set. If both RGTP.E.TE[n] and RGTNE.TE[n] are set, then this bit will be set on both a '0' to '1' and a '1' to '0' transition. This bit will not be set if the GPIO is configured as an output.

11.7.3 Theory of Operation

11.7.3.1 Power Wells

GPC0 – GPC4 are in the core well. GPR0 – GPR8 are in the resume well.

11.7.3.2 SMI# and SCI Routing

If GPE.EN[n] (whether in the core well [CGGPE] or resume well [RGGPE]) and GPEOE.GPIO is set, and the GPIO is configured as an input, GPEOS.GPIO will be set. If SMI.EN[n] (for both core well [CGSMI] and resume well [RGSMI]) and SMIE.GPIO is set, and the GPIO is configured as an input, SMIS.GPIO will be set.

11.7.3.3 Triggering

A GPIO (whether in the core well or resume well) can cause a wake event and SMI/SCI on either its rising edge, its falling edge, or both. These are controlled via the CGTPE and CGTNE registers for the core well GPIOs, and RGTP.E and RGTNE for the resume well GPIOs. If the bit corresponding to the GPIO is set, the transition will cause a wake event/SMI/SCI, and the corresponding bit in the trigger status register (CGTS for core well GPIOs, RGTS for resume well GPIOs). The event can be cleared by writing a '1' to the status bit position.



11.8 SMBus Controller

11.8.1 Overview

The processor provides an SMBus 1.0-compliant host controller. The host controller provides a mechanism for the CPU to initiate communications with SMB peripherals (slaves).

11.8.2 I/O Registers

Table 358. SMBus Controller Registers

Start	End	Symbol	Register Name/Function
00	00	HCTL	Host Control
01	01	HSTS	Host Status
02	03	HCLK	Host Clock Divider
04	04	TSA	Transmit Slave Address
05	05	HCMD	Host Command
06	06	HDO	Host Data 0
07	07	HD1	Host Data 1
20	3F	HBD	Host Block Data

11.8.2.1 Offset 00h: HCTL - Host Control Register

Table 359. 00h: HCTL - Host Control Register (Sheet 1 of 2)

Size: 8 bit		Default: 00h		Power Well: Core
Access		PCI Configuration		B:D:F
Offset Start: 00h		Offset End: 00h		
Bit Range	Default	Access	Acronym	Description
07	0	RW	SE	SMI Enable: Enable generation of an SMI# upon completion of the command.
06	0	RO	RSVD	Reserved
05	0	RW	AE	Alert Enable: Software sets this bit to enable an interrupt/SMI# due to SMBALERT#.
04	0	RW	ST	Start/Stop: Initiates the command described in the CMD field. This bit always reads zero. HSTS.BSY identifies when the processor has finished the command.
03	0	RO	RSVD	Reserved



Table 359. 00h: HCTL - Host Control Register (Sheet 2 of 2)

Size: 8 bit		Default: 00h		Power Well: Core																		
Access		PCI Configuration		B:D:F																		
Offset Start: 00h Offset End: 00h																						
Bit Range	Default	Access	Acronym	Description																		
02 : 00	0	RW	CMD	<p>Command: Indicates the command the processor is to perform. If enabled, the processor will generate an interrupt or SMI# when the command has completed. If a reserved command is issued, the processor will set HSTS.DE and perform no command, and will not operate until HSTS.DE is cleared.</p> <table border="1"> <thead> <tr> <th>Bits</th> <th>Command Description</th> </tr> </thead> <tbody> <tr> <td>000</td> <td>Quick: Uses TSA.</td> </tr> <tr> <td>001</td> <td>Byte: Uses TSA and CMD registers. TSA.R determines the direction.</td> </tr> <tr> <td>010</td> <td>Byte Data: Uses TSA, CMD, and HD0 registers. TSA.R determines the direction. If a read, HD0 will contain the read data.</td> </tr> <tr> <td>011</td> <td>Word Data: Uses TSA, CMD, HD0 and HD1 registers. TSA.R determines the direction. If a read, HD0 and HD1 contain the read data.</td> </tr> <tr> <td>100</td> <td>Process Call: Uses TSA, HCMD, HD0 and HD1 registers. TSA.R determines the direction. Upon completion, HD0 and HD1 contain the read data.</td> </tr> <tr> <td>101</td> <td>Block: Uses TSA, CMD, HD0 and HBD registers. For writes, the count is stored in HD0 and indicates how many bytes of data will be transferred. For reads, the count is received and stored in HD0. TSA.R determines the direction. For writes, data is retrieved from the first n (where n is equal to the specified count) addresses of HBD. For reads, the data is stored in HBD.</td> </tr> <tr> <td>110</td> <td>Reserved</td> </tr> <tr> <td>111</td> <td>Reserved</td> </tr> </tbody> </table>	Bits	Command Description	000	Quick: Uses TSA.	001	Byte: Uses TSA and CMD registers. TSA.R determines the direction.	010	Byte Data: Uses TSA, CMD, and HD0 registers. TSA.R determines the direction. If a read, HD0 will contain the read data.	011	Word Data: Uses TSA, CMD, HD0 and HD1 registers. TSA.R determines the direction. If a read, HD0 and HD1 contain the read data.	100	Process Call: Uses TSA, HCMD, HD0 and HD1 registers. TSA.R determines the direction. Upon completion, HD0 and HD1 contain the read data.	101	Block: Uses TSA, CMD, HD0 and HBD registers. For writes, the count is stored in HD0 and indicates how many bytes of data will be transferred. For reads, the count is received and stored in HD0. TSA.R determines the direction. For writes, data is retrieved from the first n (where n is equal to the specified count) addresses of HBD. For reads, the data is stored in HBD.	110	Reserved	111	Reserved
Bits	Command Description																					
000	Quick: Uses TSA.																					
001	Byte: Uses TSA and CMD registers. TSA.R determines the direction.																					
010	Byte Data: Uses TSA, CMD, and HD0 registers. TSA.R determines the direction. If a read, HD0 will contain the read data.																					
011	Word Data: Uses TSA, CMD, HD0 and HD1 registers. TSA.R determines the direction. If a read, HD0 and HD1 contain the read data.																					
100	Process Call: Uses TSA, HCMD, HD0 and HD1 registers. TSA.R determines the direction. Upon completion, HD0 and HD1 contain the read data.																					
101	Block: Uses TSA, CMD, HD0 and HBD registers. For writes, the count is stored in HD0 and indicates how many bytes of data will be transferred. For reads, the count is received and stored in HD0. TSA.R determines the direction. For writes, data is retrieved from the first n (where n is equal to the specified count) addresses of HBD. For reads, the data is stored in HBD.																					
110	Reserved																					
111	Reserved																					

11.8.2.2 Offset 01h: HSTS - Host Status Register

Table 360. 01h: HSTS - Host Status Register

Size: 8 bit		Default: 00h		Power Well: Core
Access		PCI Configuration		B:D:F
Offset Start: 01h Offset End: 01h				
Bit Range	Default	Access	Acronym	Description
07 : 04	0	RO	RSVD	Reserved
03	0	RO	BSY	Busy: When set, indicates the processor is running a command. No SMB registers should be accessed while this bit is set.
02	0	RWC	BE	Bus Error: When set, indicates a transaction collision.
01	0	RWC	DE	Device Error: When set, this indicates one of the following: Illegal Command Field, an unclaimed cycle, or a time-out error.
00	0	RWC	CS	Completion Status: When BSY is cleared, if this bit is set, the command completed successfully. If cleared, the command did not complete successfully.



11.8.2.3 Offset 02h: HCLK – Host Clock Divider

Table 361. 02h: HCLK – Host Clock Divider

Size: 16 bit		Default: 0000h		Power Well: Core														
Access		PCI Configuration B:D:F		Offset Start: 02h Offset End: 03h														
Bit Range	Default	Access	Acronym	Description														
15 : 00	0	RW	DIV	<p>Divider: This controls how many legacy backbone clocks should be counted for the generation of SMBCLK. Recommended values are listed below:</p> <table border="1"> <thead> <tr> <th>SMBus Frequency</th> <th>Legacy Backbone Frequency (33 MHz)</th> </tr> </thead> <tbody> <tr> <td>1 kHz</td> <td>208Eh</td> </tr> <tr> <td>10 kHz</td> <td>0342h</td> </tr> <tr> <td>50 kHz</td> <td>00A7h</td> </tr> <tr> <td>100 kHz</td> <td>0054h</td> </tr> <tr> <td>400 kHz</td> <td>0015h</td> </tr> <tr> <td>1 MHz</td> <td>0009h</td> </tr> </tbody> </table>	SMBus Frequency	Legacy Backbone Frequency (33 MHz)	1 kHz	208Eh	10 kHz	0342h	50 kHz	00A7h	100 kHz	0054h	400 kHz	0015h	1 MHz	0009h
SMBus Frequency	Legacy Backbone Frequency (33 MHz)																	
1 kHz	208Eh																	
10 kHz	0342h																	
50 kHz	00A7h																	
100 kHz	0054h																	
400 kHz	0015h																	
1 MHz	0009h																	

11.8.2.4 Offset 04h: TSA - Transmit Slave Address

This register contains the address of the intended target.

Table 362. 04h: TSA - Transmit Slave Address

Size: 8 bit		Default: 00h		Power Well: Core
Access		PCI Configuration B:D:F		Offset Start: 04h Offset End: 04h
Bit Range	Default	Access	Acronym	Description
07 : 01	0	RW	AD	Address: 7-bit address of the targeted slave.
00	0	RW	R	Read: Direction of the host transfer. 1 = read, 0 = write

11.8.2.5 Offset 05h: HCMD - Host Command Register

This field is transmitted in the command field of the SMB protocol during the execution of any command.

Table 363. 05h: HCMD - Command Register

Size: 16 bit		Default:		Power Well: Core
Access		PCI Configuration B:D:F		Offset Start: 05h Offset End: 05h
Bit Range	Default	Access	Acronym	Description



11.8.2.6 Offset 06h: HD0 - Host Data 0

This field is transmitted in the DATA0 field of an SMBus cycle. For block writes, this register reflects the number of bytes to transfer. This register should be programmed to a value between 1h (1 bytes) and 20h (32 bytes) for block counts. A count of 00h or above 20h will result in no transfer and HSTS.CS will be cleared, indicating a failure.

Table 364. 06h: HD0 - Host Data 0

Size: 16 bit		Default:		Power Well: Core
Access		PCI Configuration		Offset Start: 06h Offset End: 06h
Bit Range	Default	Access	Acronym	Description

11.8.2.7 Offset 07h: HD1 - Host Data 1

This field is transmitted in the DATA1 field of an SMBus cycle.

Table 365. 07h: HD1 - Host Data 1

Size: 16 bit		Default:		Power Well: Core
Access		PCI Configuration		Offset Start: 07h Offset End: 07h
Bit Range	Default	Access	Acronym	Description

11.8.2.8 Offset 20h – 3Fh: HBD – Host Block Data

Table 366. 20h – 3Fh: HBD – Host Block Data

Size: 256 bit		Default: 0h		Power Well: Core
Access		PCI Configuration		Offset Start: 20h Offset End: 3Fh
Bit Range	Default	Access	Acronym	Description
255 : 00	0	RW	D	Data: This contains block data to be sent on a block write command, or received block data, on a block read command. Any data received over 32-bytes will be lost.

11.8.3 Overview

The host controller is used to send commands to other SMB devices. It runs off of the backbone clock, with a minimum SMBCLK frequency the backbone clock divided by 4 (i.e., SMBCLK, at a minimum, is 4 legacy backbone clocks). The frequency to use for SMBCLK is chosen by programming HCLK.DIV. To ensure proper data capture, the minimum value to be programmed into this register is 9h (for 33 MHz legacy backbone), resulting in a frequency roughly equivalent to 1 MHz. Software then sets up the host controller with an address, command, and for writes, data, and then tells the controller to start. When the controller has finished transmitting data on writes, or receiving data on reads, it will generate an SMI#, if enabled.



The host controller supports eight command protocols of the SMB interface (see the *System Management Bus Specification*, Version 1.0.): Quick Command, Send Byte, Receive Byte, Write Byte/Word, Read Byte/Word, Process call, Block Read, Block Write and Block write-block read process call.

The host controller requires the various data and command fields be setup for the type of command to be sent. When software sets HCTL.ST, the host controller will perform the requested transaction and generate an SMI# (if enabled) when finished. Once started, the values of the HCTL, HCMD, TSA, HDO, and HD1 should not be changed or read until HSTS.BSY has been cleared. The host controller will update all registers while completing the new command.

11.8.4 Bus Arbitration

Several masters may attempt to get on the bus at the same time by driving SMBDATA low to signal a start condition. When the processor releases SMBDATA, and samples it low, then some other master is driving the bus and the processor must stop transferring data. If the processor loses arbitration, it sets HSTS.BE, and if enabled, generates an interrupt or SMI#. The CPU is responsible for restarting the transaction.

11.8.5 Bus Timings

The SMBus runs at between 10-100 kHz. The processor SMBus runs off of the backbone clock.

Table 367. SMBus Timings

Timing	Min AC	Spec Name
t _{LOW}	4.7 μs	Clock low period
t _{HIGH}	4.0 μs	Clock high period
t _{SU:DAT}	250 ns	Data setup to rising SMBCLK
t _{HD:DAT}	0 ns	Data hold from falling SMBCLK
t _{HD:STA}	4.0 μs	Repeat Start Condition generated from rising SMBCLK
t _{SU:STA}	4.7 μs	First clock fall from start condition
t _{SU:STO}	4.0 μs	Last clock rising edge to last data rising edge (stop condition)
t _{BUF}	4.7 μs	Time between consecutive transactions

The Min AC column indicates the minimum times required by the SMBus specification. The processor tolerates these timings. When the processor is sending address, command, or data bytes, it will drive data relative to the clock it is also driving. It will not start toggling the clock until the start or stop condition meets proper setup and hold. The processor will also guarantee minimum time between SMBus transactions as a master.

11.8.5.1 Clock Stretching

Devices may stretch the low time of the clock. When the processor attempts to release the clock (allowing the clock to go high), the clock will remain low for an extended period of time. The processor monitors SMBCLK after it releases the bus to determine whether to enable the counter for the high time of the clock. While the bus is still low, the high time counter must not be enabled. The low period of the clock can be stretched by an SMBus master if it is not ready to send or receive data.

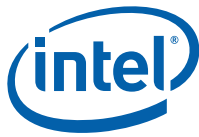

11.8.5.2 Bus Time Out

If there is an error in the transaction, such that a device does not signal an acknowledge, or holds the clock lower than the allowed time-out time, the transaction will time out. The processor will discard the cycle, and set HSTS.DE. The time out minimum is 25 ms. The time-out counter inside the processor will start when the first bit of data is transferred by the processor.

11.8.6 SMI#

The system can be set up to generate SMI# by setting HCTL.SE.

11.9 Serial Peripheral Interface

11.9.1 Overview

The Serial Peripheral Interface (SPI) is a 4-pin interface that provides a potentially lower-cost alternative for system flash versus the Firmware Hub interface that is available on the LPC pins.

11.9.2 Features

Goals for the SPI Architecture in the Product

- Support for Multiple SPI Flash Vendors
- Simple Hardware
 - Equivalence to LPC-Based firmware hubs
 - Provide write protection scheme
 - Equivalent performance (boot time, resume time)
 - Top swap functionality
 - Support for E & F segments below 1 MB
 - 64 kb-granular protection
 - Max SPI flash size addressable by the processor is 8 MB (8 MB is hardware allowed BIOS address decode range)
 - Data throughput of the SPI bus is 20 Mbps

Note that the SPI does not provide support for very large BIOS sizes as easily as the FWH interface. The processor SPI interface is restricted to one Chip Select pin. The Serial Peripheral Interface (SPI) is a 4-pin interface that provides a potentially lower-cost alternative for system flash versus the Firmware Hub interface that is available on the LPC pins.

11.9.3 External Interface

Table 368. SPI Pin Interface

Signal(s)	Width	Type	IO Type	Description
SPI_SCLK	1	O	LVTTTL, 3.3V	Serial bit-rate clock 20/33 MHz
SPI_CS#	1	O	LVTTTL, 3.3V	CS for slave
SPI_MOSI	1	O	LVTTTL, 3.3V	Master data out / Slave In
SPI_MISO	1	I	LVTTTL, 3.3V	Master data in / Slave out



Table 369. GPIO Boot Source Selection

GPIO[0]	Description
1	Boot from SPI
0	Boot from LPC

11.9.4 SPI Protocol

Communication on the SPI bus is done with a Master – Slave protocol. Typical bus topologies call for a single SPI Master with a single SPI Slave. The SPI interface consists of a four wire interface: clock (CLK), master data out (Master Out Slave In (MOSI)), master data in (Master In Slave Out (MISO)) and an active low chip select (CS#).

11.9.4.1 SPI Pin Level Protocol

SPI communicates utilizing a synchronous protocol with the clock driven by the Master. After selecting a Slave by asserting the SPI_CS# signal, the Master generates eight clock pulses per byte on the SPI_SCK wire, one clock pulse per data bit. Data flows from master to slave on the SPI_MOSI wire and from slave to master on the SPI_MISO wire. Data is setup and sampled on opposite edges of the SPI_SCK signal. Master drives data off of the falling edge of the clock and slave samples on the rising edge of the clock. Similarly, Slave drives data off of the falling edge of the clock. The master has more flexibility on sampling schemes since it controls the clock.

Note:

SPI_SCK flight times and the device SPI_MISO max valid times indicate that the rising edge is not feasible for sampling the SPI_MISO input at the master for a 22 MHz clock period with 50% duty cycle.

1. SPI supports 8- or 16-bit words, however all devices on the supported list only operate on 8-bit words.
2. SPI specifies that data can be shifted MSB or LSB first, however all devices on the supported list only operate MSB first.

Figure 9. Basic SPI Protocol

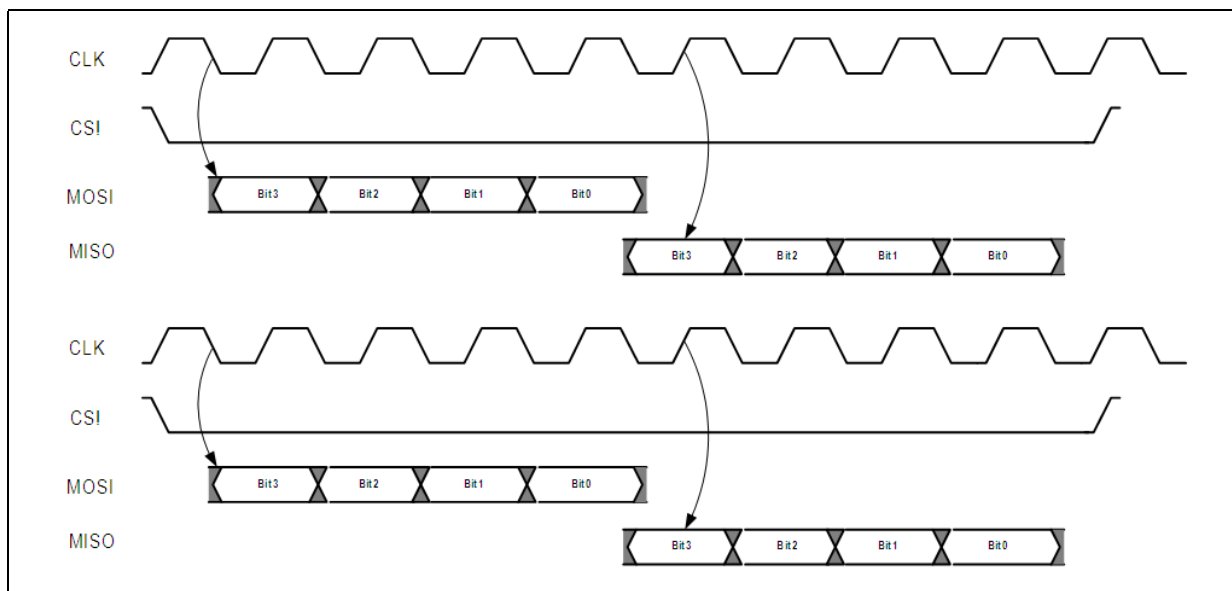

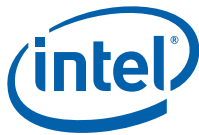

The processor only supports Mode 0.

Commands, Addresses and Data are shifted most significant bit (MSB) first. For the 24-bit address, this means bit 23 is shifted first while bit 0 is shifted last. However, for data bursts, bytes are shifted out from *least significant byte to most significant byte*, where each byte is shifted (MSB to LSB).

11.9.4.1.1 Addressing

A Slave is targeted for a cycle when its SPI_CS# pin is asserted. Besides Slave addressing there is register addressing within the Slave itself. The list of processor supported devices' includes only FLASH devices. See supported devices data sheets for more information.

11.9.4.1.2 Data Transaction

All transactions on the SPI bus must be a multiple of 8 bits. A frame consists of any number of 8-bit data packets. To initiate a data transfer, the SPI Master asserts (high to low transition) the SPI_CS# signal informing the SPI Slave that it is being targeted for a cycle. The Master will then shift out the 8-bit opcode followed by the Slave's internal address.

In the case of a Read transaction, the Slave will interpret the Slave address and begin driving data out on the SPI_MISO pin and ignore any transactions on the SPI_MOSI pin. The Master indicates Read complete by deasserting the SPI_CS# signal on an 8-bit boundary.

In the case of a Write transaction, the Slave will continue to receive Master data on the SPI_MOSI pin. The Write transaction is completed upon deassertion of the SPI_CS# signal on an 8-bit boundary.

The SPI bus does include a mechanism for flow control, however some devices include the support of a HOLD signal. See Slave documentation for more information. If the Slave receives an un-recognized or invalid opcode it should ignore the rest of the packet and wait for the deassertion of SPI_CS#.

11.9.4.1.3 Bus Errors

If the first 8 bits specify an opcode which is not supported the slave will not respond and wait for the next high to low transition on SPI_CS#.

SPI hardware should automatically discard 8-bit words that were not completely received upon deassertion of the SPI_CS# signal.

Any other error correction or detection mechanisms must be implemented in firmware/software.

11.9.4.1.4 Instructions

Table 370. Instructions (Sheet 1 of 2)

Instruction	ST* M25P80 (8 Mb)	ST* M45P80 (8 Mb)	NexFlash* NX25P	SST* 25V040 (4 Mb) SST* 25VF080 (8 Mb)
Write Status	01	-	01	01
Data Program	02	02	02	02
Read Data	03	03	03	03
Write Disable	04	04	04	04
Read Status	05	05	05	05

**Table 370. Instructions (Sheet 2 of 2)**

Instruction	ST* M25P80 (8 Mb)	ST* M45P80 (8 Mb)	NexFlash* NX25P	SST* 25V040 (4 Mb) SST* 25VF080 (8 Mb)
Write Enable	06	06	06	06
Page Write	-	0A	-	-
Fast Read (1)	0B	0B	0B	-
Ena Write Status	-	-	-	50
256B Erase	-	DB	-	-
4 kByte Erase	-	-	-	20
64 kB Erase	D8	D8	D8	52
Chip Erase	C7	-	C7	60
Auto Add Inc (2)	-	-	-	AF
Power Down/Up	B9 / AB	B9 / AB	B9	-
Read ID	-	9F	90	AB or 90

Note:

1. Fast Read Protocol is not supported processor processor processor processor .
2. The Auto Address Increment type is not supported.

11.9.4.1.5 SPI Timings

The SPI interface is designed to fall within the following protocol timing specs. These specs are intended to operate with most SPI Flash devices.

Table 371. SPI Cycle Timings

Parameter	Minimum Value	Description
SPI_CS# Setup	30 ns	SPI_CS# low to SPI_SCK high
SPI_CS# Hold	30 ns	SPI_SCK low to SPI_CS# low
Clock High	20 ns	Time that SPI_SCK is Driven high per clock period
Clock Low	30 ns	Time that SPI_SCK is Driven Low per clock period

11.9.5 Host Side Interface

11.9.5.1 SPI Host Interface Registers

The SPI Host Interface are memory-mapped in the RCRB Chipset Memory Space in range 3020h to 308Fh.

Warning: Address locations that are not listed are considered reserved register locations. Reads to reserved registers may return non-zero values. Writes to reserved locations may cause system failure.

The table below does NOT include the 3020h offset.

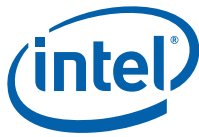

Table 372. Bus 0, Device 31, Function 0, PCI Register Mapped Through RCBA BAR

Offset Start	Offset End	Register ID – Description	Default Value
3020h	3021h	Offset 00h: SPIS - SPI Status	0001h
3022h	3023h	Offset 02h: SPIC - SPI Control	2005h
3024h	3027h	Offset 04h: SPIA - SPI Address	00XXXXXh
3028h	302Bh	Offset 08h: SPID0 - SPI Data 0	XXXXXXXXh
3030h at 4h	306Ch at 4h	Offset 10h, 18h, 20h, 28h, 30h, 38h, 40h: SPI[0-6] - SPI Data [0-6]	00000000h
3070h	3073h	Offset 50h: BBAR - BIOS Base Address	00000000h
3074h	3075h	Offset 54h: PREOP - Prefix Opcode Configuration	0004h
3076h	3077h	Offset 56h: OPTYPE - Op Code Type	0000h
3078h	307Fh	Offset 58h: OPMENU - OPCODE Menu Configuration	00000005h
3080h at 4h	3083h at 4h	Offset 60h: PBR0 - Protected BIOS Range #0	00000000h

11.9.5.2 Offset 00h: SPIS – SPI Status

Table 373. 00h: SPIS - SPI Status

Size: 16 bit		Default: 0001h		Power Well: Core
Access		PCI Configuration B:D:F 0:31:0		Offset Start: 3020h Offset End: 3021h
		Memory Mapped IO BAR: RCBA		Offset:
Bit Range	Default	Access	Acronym	Description
15	0	RWL	SCL	SPI Configuration Lock-Down: When set to 1, the SPI Static Configuration information in offsets 50h through 6Bh can not be overwritten. Once set to 1, this bit can only be cleared by a hardware reset.
14 : 4	0	RV	RSVD	Reserved
3	0	RWC	BAS	Blocked Access Status: Hardware sets this bit to 1 when an access is blocked from running on the SPI interface due to one of the protection policies or when any of the programmed cycle registers are written while a programmed access is already in progress. This bit is set for both programmed accesses and direct memory reads that get blocked. This bit remains asserted until cleared by software writing a 1 or hardware reset.
2	0	RWC	CDS	Cycle Done Status: The processor sets this bit to 1 when the SPI Cycle completes (i.e., SCIP bit is 0) after software sets the GO bit. This bit remains asserted until cleared by software writing a 1 or hardware reset. When this bit is set and the SPI bit in Offset 02h: SPIC – SPI Control is set, an internal signal is asserted to the SMI# generation block. Software must make sure this bit is cleared prior to enabling the SPI SMI# assertion for a new programmed access. This bit gets set after the Status Register Polling sequence completes after reset deasserts. It is cleared before and during that sequence.
1	0	RV	RSVD	Reserved
0	1	RO	SCIP	SPI Cycle In Progress: Hardware sets this bit when software sets the SPI Cycle Go bit in the Offset 02h: SPIC – SPI Control . This bit remains set until the cycle completes on the SPI interface. Hardware automatically sets and clears this bit so that software can determine when read data is valid and/or when it is safe to begin programming the next command. Software must only program the next command when this bit is 0. This bit reports 1b during the Status Register Polling sequence after reset deasserts; it is cleared when that sequence completes.

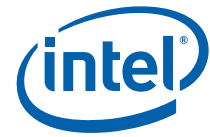

11.9.5.3 Offset 02h: SPIC – SPI Control

Table 374. 02h: SPIC - SPI Control

Size: 16 bit		Default: 2005h		Power Well: Core
Access	PCI Configuration		B:D:F 0:31:0	Offset Start: 3022h Offset End: 3023h
	Memory Mapped IO		BAR: RCBA	Offset:
Bit Range	Default	Access	Acronym	Description
15	0	RW	SSMIE	SPI SMI# Enable: When set to 1, the SPI asserts an SMI# request whenever the Cycle Done Status bit is 1.
14	1	RW	DC	Data Cycle: When set to 1, there is data that corresponds to this transaction. When 0, no data is delivered for this cycle, and the DBC and data fields themselves are don't cares.
13:08	0	RW	DBC	Data Byte Count: This field specifies the number of bytes to shift in or out during the data portion of the SPI cycle. The valid settings (in decimal) are any value from 0 to 63. The number of bytes transferred is the value of this field plus 1. Note that when this field is 00_0000b, then there is 1 byte to transfer and that 11_1111b means there are 64 bytes to transfer.
7	0	RV	RSVD	Reserved
6:04	0	RW	COP	Cycle Opcode Pointer: This field selects one of the programmed opcodes in the Offset 58h: OPMENU – Opcode Menu Configuration to be used as the SPI Command/Opcode. In the case of an Atomic Cycle Sequence, this determines the second command.
3	0	RW	SPOP	Sequence Prefix Opcode Pointer: This field selects one of the two programmed prefix opcodes for use when performing an Atomic Cycle Sequence. A value of 0 points to the opcode in the least significant byte of the Offset 54h: PREOP – Prefix Opcode Configuration register. By making this programmable, the processor supports flash devices that have different opcodes for enabling writes to the data space vs. status register.
2	1	RW	ACS	Atomic Cycle Sequence: When set to 1 along with the SCGO assertion, the processor will execute a sequence of commands on the SPI interface. The sequence is composed of: Atomic Sequence Prefix Command (8-bit opcode only) Primary Command specified by software (can include address and data) Polling the Flash Status Register (opcode 05h) until bit 0 becomes 0b. The SPI Cycle in Progress bit remains set and the Cycle Done Status bit in Offset 00h: SPIS – SPI Status register remains unset until the Busy bit in the Flash Status Register returns 0.
1	0	RWS	SCGO	SPI Cycle Go: This bit always returns 0 on reads. However, a write to this register with a '1' in this bit starts the SPI cycle defined by the other bits of this register. The SPI Cycle in Progress (SCIP) bit in Offset 00h: SPIS – SPI Status register gets set by this action. Hardware must ignore writes to this bit while the SPI Cycle In Progress bit is set. Hardware allows other bits in this register to be programmed for the same transaction when writing this bit to 1. This saves an additional memory write.
0	1		RSVD	Reserved



11.9.5.4 Offset 04h: SPIA – SPI Address

Table 375. 04h: SPIA - SPI Address

Size: 32 bit		Default: 00XXXXXh		Power Well: Core
Access		PCI Configuration B:D:F 0:31:0		Offset Start: 3024h Offset End: 3027h
		Memory Mapped IO BAR: RCBA		Offset:
Bit Range	Default	Access	Acronym	Description
31 :24	0	RV	RSVD	Reserved
23 :00	0	RW	SCA	SPI Cycle Address: This field is shifted out as the SPI Address (MSB first).

11.9.5.5 Offset 08h: SPIDO – SPI Data 0

Table 376. 08h: SPIDO - SPI Data 0

Size: 64 bit		Default: XXXXXXXXh		Power Well: Core
Access		PCI Configuration B:D:F 0:31:0		Offset Start: 3028h Offset End: 302Bh
		Memory Mapped IO BAR: RCBA		Offset:
Bit Range	Default	Access	Acronym	Description
63 :00	0	RWO	SCD	<p>SPI Cycle Data 0 (SCDO): This field is shifted out as the SPI Data on the Master-Out Slave-In Data pin (SPI_MOSI) during the data portion of the SPI cycle.</p> <p>This register also shifts in the data from the Master-In Slave-Out pin (SPI_MISO) into this register during the data portion of the SPI cycle.</p> <p>The data is always shifted starting with the least significant byte, MSB to LSB, followed by the next least significant byte, MSB to LSB, etc. Specifically, the shift order on SPI in terms of bits within this register is: 7-6-5-4-3-2-1-0-15-14-13-...8-23-22-...16-31...24-39...32...etc. Bit 56 is the last bit shifted out/in. There are no alignment assumptions; byte 0 always represents the value specified by the cycle address.</p> <p>Note that the data in this register may be modified by the hardware during any programmed SPI transaction. Direct Memory Reads do not modify the contents of this register. (This last requirement is needed in order to properly handle the collision case described in Section 11.9.5.13.)</p> <p>This register is initialized to 0 by the reset assertion. However, the least significant byte of this register is loaded with the first Status Register read of the Atomic Cycle Sequence that the hardware automatically runs out of reset. Therefore, bit 0 of this register can be read later to determine if the platform encountered the boundary case in which the SPI flash was busy with an internal instruction when the platform reset deasserted.</p>



11.9.5.6 Offset 10h, 18h, 20h, 28h, 30h, 38h, 40h: SPID[0-6] – SPI Data N

Table 377. 10h, 18h, 20h, 28h, 30h, 38h, 40h: SPID[0-6] - SPI Data [0-6]

Size: 64 bit		Default: 00000000h		Power Well: Core
Access	PCI Configuration		B:D:F 0:31:0	Offset Start: 3030h at 4h Offset End: 306Ch at 4h
	Memory Mapped IO		BAR: RCBA	Offset:
Bit Range	Default	Access	Acronym	Description
63 : 00	0	RW0	SCD	SPI Cycle Data N (SCD[N]): Similar definition as SPI Cycle Data 0. However, this register does not begin shifting until SPID[N-1] has completely shifted in/out.

11.9.5.7 Offset 50h: BBAR – BIOS Base Address

This register is not writable when the SPI Configuration Lock-Down bit in [Offset 00h: SPIS – SPI Status](#) register is set.

Table 378. 50h: BBAR - BIOS Base Address

Size: 32 bit		Default: 00000000h		Power Well: Core
Access	PCI Configuration		B:D:F 0:31:0	Offset Start: 3070h Offset End: 3073h
	Memory Mapped IO		BAR: RCBA	Offset:
Bit Range	Default	Access	Acronym	Description
31 : 24	0	RV	RSVD	Reserved
23 : 08	0	RWS	BSP	Bottom of System Flash: This field determines the bottom of the System BIOS. The processor will not run programmed commands nor memory reads whose address field is less than this value. This field corresponds to bits 23:8 of the 3-byte address; bits 7:0 are assumed to be 00h for this vector when comparing to a potential SPI address. Software must always program 1's into the upper, Don't Care bits of this field based on the flash size. Hardware does not know the size of the flash array and relies upon the correct programming by software. The default value of 0000h results in all cycles allowed. Note: The SPI Host Controller prevents any Programmed cycle using the Address Register with an address less than the value in this register. Some flash devices specify that the Read ID command must have an address of 0000h or 0001h. If this command must be supported with these devices, it must be performed with the BBAR - BIOS Base Address programmed to 0h. Some of these devices have actually been observed to ignore the upper address bits of the Read ID command.
7 : 00	0	RV	RSVD	Reserved

11.9.5.8 Offset 54h: PREOP – Prefix Opcode Configuration

This register is not writable when the SPI Configuration Lock-Down bit in [Offset 00h: SPIS – SPI Status](#) register is set.



Table 379. 54h: PREOP - Prefix Opcode Configuration

Size: 16 bit		Default: 0004h		Power Well: Core
Access		PCI Configuration B:D:F 0:31:0		Offset Start: 3074h Offset End: 3075h
		Memory Mapped IO BAR: RCBA		Offset:
Bit Range	Default	Access	Acronym	Description
15 : 08	0	RWS	PO1	Prefix Opcode 1: Software programs an SPI opcode into this field that is permitted to run as the first command in an atomic cycle sequence.
7 : 00	04h	RWS	PO0	Prefix Opcode 0: Software programs an SPI opcode into this field that is permitted to run as the first command in an atomic cycle sequence.

11.9.5.9 Offset 56h: OPTYPE – Opcode Type Configuration

This register is not writable when the SPI Configuration Lock-Down bit in [Offset 00h: SPIS – SPI Status](#) register is set. Entries in this register correspond to the entries in the [Offset 58h: OPMENU – Opcode Menu Configuration](#) register. Note that the definition below only provides write protection for opcodes that have addresses associated with them. Therefore, any erase or write opcodes that do not use an address should be avoided (for example, “Chip Erase” and “Auto-Address Increment Byte Program”).

Table 380. 56h: OPTYPE - Opcode Type

Size: 16 bit		Default: 0000h		Power Well: Core
Access		PCI Configuration B:D:F 0:31:0		Offset Start: 3076h Offset End: 3077h
		Memory Mapped IO BAR: RCBA		Offset:
Bit Range	Default	Access	Acronym	Description
15 : 14	0	RWS	OT7	Opcode Type 7: See the description for bits 1:0
13 : 12	0	RWS	OT6	Opcode Type 6: See the description for bits 1:0
11 : 10	0	RWS	OT5	Opcode Type 5: See the description for bits 1:0
9 : 08	0	RWS	OT4	Opcode Type 4: See the description for bits 1:0
7 : 06	0	RWS	OT3	Opcode Type 3: See the description for bits 1:0
5 : 04	0	RWS	OT2	Opcode Type 2: See the description for bits 1:0
3 : 02	0	RWS	OT1	Opcode Type 1: See the description for bits 1:0
1 : 00	0	RWS	OT0	Opcode Type 0: This field specifies information about the corresponding Opcode 0. This information allows the hardware to 1) know whether to use the address field and 2) provide BIOS protection capabilities. The hardware implementation also uses the read vs. write information for modifying the behavior of the SPI interface logic. The encoding of the two bits is: 00 = No Address associated with this Opcode and Read Cycle type 01 = No Address associated with this Opcode and Write Cycle type 10 = Address required; Read cycle type 11 = Address required; Write cycle type

11.9.5.10 Offset 58h: OPMENU – Opcode Menu Configuration

This register is not writable when the SPI Configuration Lock-Down bit in [Offset 00h: SPIS – SPI Status](#) register is set. Eight entries are available in this register to give BIOS a sufficient set of commands for communicating with the flash device, while also restricting what malicious software can do. This keeps the hardware flexible enough to operate with a wide variety of SPI devices.



It is recommended that BIOS avoid programming Write Enable opcodes in this menu. Malicious software could then perform writes and erases to the SPI flash without using the atomic cycle mechanism. Write Enable opcodes should only be programmed in the [Offset 54h: PREOP – Prefix Opcode Configuration](#).

Table 381. 58h: OPMENU - OPCODE Menu Configuration

Size: 64 bit		Default: 00000005h		Power Well: Core
Access		PCI Configuration B:D:F 0:31:0		Offset Start: 3078h Offset End: 307Fh
		Memory Mapped IO BAR: RCBA		Offset:
Bit Range	Default	Access	Acronym	Description
63 : 56	0	RWS	AO7	Allowable Opcode 7: See the description for bits 7:0
55 : 48	0	RWS	AO6	Allowable Opcode 6: See the description for bits 7:0
47 : 40	0	RWS	AO5	Allowable Opcode 5: See the description for bits 7:0
39 : 32	0	RWS	AO4	Allowable Opcode 4: See the description for bits 7:0
31 : 24	0	RWS	AO3	Allowable Opcode 3: See the description for bits 7:0
23 : 16	0	RWS	AO2	Allowable Opcode 2: See the description for bits 7:0
15 : 08	0	RWS	AO1	Allowable Opcode 1: See the description for bits 7:0
7 : 00	05h	RWS	AO0	Allowable Opcode 0: Software programs an SPI opcode into this field for use when initiating SPI commands through the Control Register.

11.9.5.11 Offset 60h: PBR0 – Protected BIOS Range [0-2]

This register can not be written when the SPI Configuration Lock-Down bit in [Offset 00h: SPIS – SPI Status](#) register is set to 1.

Table 382. 60h: PBR0 - Protected BIOS Range #0

Size: 32 bit		Default: 00000000h		Power Well: Core
Access		PCI Configuration B:D:F 0:31:0		Offset Start: 3080h at 4h Offset End: 3083h at 4h
		Memory Mapped IO BAR: RCBA		Offset:
Bit Range	Default	Access	Acronym	Description
31	0	RW-Special	WPE	Write Protection Enable: When set, this bit indicates that the Base and Limit fields in this register are valid and that writes directed to addresses between them (inclusive) must be blocked by hardware. The base and limit fields are ignored when this bit is cleared.
30 : 24	0	RV	Reserved	Reserved
23 : 12	000h	RW- Special	PRL	Protected Range Limit: This field corresponds to SPI address bits 23:12 and specifies the upper limit of the protected range. Address bits 11:0 are assumed to be FFFh for the limit comparison. Any address greater than the value programmed in this field is unaffected by this protected range.
11 : 00	000h	RW- Special	PRB	Protected Range Base: This field corresponds to SPI address bits 23:12 and specifies the lower base of the protected range. Address bits 11:0 are assumed to be 000h for the base comparison. Any address less than the value programmed in this field is unaffected by this protected range.

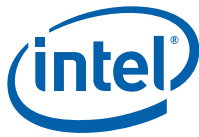

11.9.5.12 Running SPI Cycles from the Host

11.9.5.12.1 Memory Reads

Memory Reads to the BIOS Range result in a READ command (03h) with the lower 3 bytes of the address delivered in the SPI cycle. By sending the entire 24 bits of address out to the SPI interface unchanged, the processor hardware can support various flash memory sizes without having straps or automatic detection algorithms in hardware. The flash memory device must ignore the upper address bits such that an address of FFFFFFFh simply aliases to the top of the flash memory. This is true for all supported flash devices. When considering additional flash parts, this behavior should be checked.

For compatibility with the FWH interface, the SPI interface supports decoding the two 64 KB BIOS ranges at the E0000h and F0000h segments just below 1 MB. These ranges must be re-directed (aliased) to the ranges just below 4 GB by the processor. This is done by forcing the upper address bits (23:20) to 1's when performing the read on the SPI interface.

When the SPI Prefetch Enable bit in [Offset D8h: BC: BIOS Control Register](#) is set, the processor checks if the starting address for a read is aligned to the start of a 64B block (i.e., address bits 5:0 are 00h). If this is not the case, then the processor only reads the length specified by the current read. If the read is aligned to the start of the 64B block with the SPI Prefetch Enable bit set, then the read burst continues on the SPI pins until 64 bytes have been received. Note that the processor always performs the entire 64B burst when the conditions are met to perform the prefetch when the memory read request is received. This policy can result in a large penalty if the read addresses are not sequential. Software is allowed and encouraged to dynamically turn on prefetching only when the reads are sequential (for example, if shadowing the BIOS using consecutive DWord reads).

When prefetching is enabled, the read buffer must be enabled for caching. If the processor detects a read to the range that is currently in (or being fetched for) the read buffer, it will not perform another read cycle on the SPI pins. Instead, the data is returned from the read buffer. Note that the entire read request must be contained in the cache in order to avoid running the read on the SPI interface.

The following events invalidate the read buffer “cache”:

1. A Programmed Access begins. Note that if the cycle is blocked from running for protection or other reasons, the cache is not flushed.
2. A Memory read to a BIOS range that does not hit the range in the read buffer
3. System Reset
4. Software setting the Cache Disable bit (and clearing the Prefetch Enable) in [Offset D8h: BC: BIOS Control Register](#). This can serve as a way to flush the cache in software.

Even when prefetching is disabled, the read buffer can act as a cache for Direct Memory Read Data. This is a potentially valuable boot-time optimization that leverages the basic caching mechanism that is needed for prefetching anyway. The cache is loaded with the data received on every Direct Memory Read that runs on the SPI pins. That data remains valid within the cache until any one of the conditions listed above occurs. For the cache to work properly, the Direct Memory Read must be fully contained within a 64-byte aligned range. The following events result in a valid read buffer cache when the caching is enabled:

1. A host read to the SPI BIOS with a length of 64 Bytes. This cycle must be aligned to a 64B boundary.
2. A host read to the SPI BIOS of any length with a 64B-aligned address and prefetching is enabled.

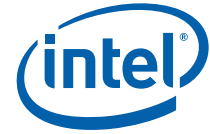

Note that, although the SPI interface may “burst ahead” for up to 64 bytes, the Host Interface may still have to wait for prefetched data to arrive from the flash before generating the completion back to the processor. The round trip delay for the platform to complete one DWord and run the host read for the next sequential DWord can be shorter than the SPI time to receive another 32 bits.

If a Direct Memory Read targeting the SPI flash is received while the host interface is already busy with either another Direct Memory Read or a Programmed Access, then the SPI Host hardware will hold the new Direct Memory Read (and the host processor) pending until the preceding SPI access completes. Note that it is possible for a second Direct Memory Read to be received while the prefetching continues for a first Direct Memory Read.

The SPI interface provides empty flash detection equivalent to FWH (i.e., 1’s on the initial boot access.)

It is possible that a Direct Memory Read targeting the SPI flash can be issued with noncontiguous byte enables. While the CPU cannot create these cycles, peer agents can.

The SPI interface handles these Direct Memory Read transactions in the following fashion. Note that the byte enables in the table are active high, and BE[3] is the most significant byte enable of the DWord.

Table 383. Byte Enable Handling on Direct Memory Reads

# DWords Requested	First DWord BE[3:0]	Last DWord BE[3:0]	Action Taken
1	0000	Don't Care	Zero bytes read from SPI, no SPI transaction started
1	0001, 0010, 0100, 1000, 0011, 0110, 1100, 0111, 1110, 1111	Don't Care	Bytes read from SPI = bytes requested starting from lowest requested byte
1	0101, 1001, 1010, 1011, 1101	Don't Care	Full DW (4 bytes) requested from SPI
>1	0000	Don't Care	Undefined behavior. Illegal protocol
>1	1000, 1100, 1110, 1111	Don't Care	Bytes read from SPI = 4 * (num DW - 1) + bytes requested in first DW. Address starts from lowest requested byte.
>1	0001, 0010, 0011, 0100, 0101, 0110, 0111, 1001, 1010, 1011, 1101	Don't Care	Bytes read from SPI = 4 * num DW

When coming out of a platform reset, the SPI Host Controller must hold the initial Direct Memory Read from the processor pending until the SPI flash is no longer busy with an internal write or erase instruction. In order to achieve this, the host controller reads the Status Register (opcode = 05h) of the flash device until bit 0 is cleared. This is equivalent to the polling performed following an atomic cycle, during which the Direct Memory Reads are held pending. Depending on the type of flash and type of long instruction performed, the delay could be long enough to cause a watchdog time-out in the processor or chipset. Although this error condition is deemed acceptable in response to this rare error scenario (reset during flash update), it can be avoided altogether by selecting flash instructions on SPI devices that complete in less than ~1 second. Note that in the typical boot case, the status read on the SPI interface will complete well before the processor boot fetch due to the delay from reset deassertion to CPURST# deassertion.



11.9.5.13 Generic Programmed Commands

All commands other than the standard (memory) reads must be programmed by the BIOS in the SPI Control, address, data, and opcode configuration registers in [Section 11.9.5.1](#). The opcode type in [Offset 56h: OPTYPE – Opcode Type Configuration](#) and data byte count fields in [Offset 54h: PREOP – Prefix Opcode Configuration](#) determine how many clocks to run before deasserting the chip enable. The flash data is always shifted in for the number of bytes specified and the BIOS out data is always shifted out for the number of data bytes specified.

Note that the hardware restricts the burst lengths that are allowed.

The status bit in [Offset 00h: SPIS – SPI Status](#) indicates when the cycle has completed on the SPI port allowing the host to know when read results can be checked and/or when to initiate a new command.

The processor also provides the “Atomic Cycle Sequence” for performing erases and writes to the SPI flash in [Offset 02h: SPIC – SPI Control](#). When this bit is 1 (and the SPI Cycle Go bit is written to 1), a sequence of cycles is performed on the SPI interface. In this case, the specified cycle is preceded by the Prefix Command (8-bit programmable opcode) and followed by repeated reads to the Status Register (opcode 05h) until bit 0 indicates the cycle has completed. The hardware does not attempt to check that the programmed cycle is a write or erase.

If a Programmed Access is initiated (SPI Cycle Go written to 1) while the SPI host interface logic is already busy with a Direct Memory Read, then the SPI Host hardware will hold the new Programmed Access pending until the preceding SPI access completes. It will then begin to request the SPI bus for the Programmed Access.

Once the SPI Host hardware has committed to running a programmed access, subsequent writes to the programmed cycle registers that occur before it has completed will not modify the original transaction and will result in the assertion of the Blocked Access Status bit in [Offset 00h: SPIS – SPI Status](#). Software should never purposely behave in this way and rely on this behavior. However, the Blocked Access Status bit provides basic error-reporting in this situation. Writes to the following registers causes the Blocked Access Status bit assertion in this situation:

[Offset 02h: SPIC – SPI Control](#)

[Offset 04h: SPIA – SPI Address](#)

[Offset 08h: SPID0 – SPI Data 0](#)

11.9.5.14 Flash Protection

There are two types of Flash Protection mechanisms:

1. BIOS Range Write Protection
2. SMI# - Based Global Write Protection

The two mechanisms are conceptually ORed together such that if any of the mechanisms indicate that the access should be blocked, then it is blocked. [Table 384](#) provides a summary of the two mechanisms.

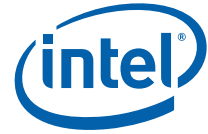
**Table 384. Flash Protection Summary**

Mechanism	Accesses Blocked	Range Specific	Reset-Override or SMI #-Override	Equivalent Function on FWH
BIOS Range Write Protection	Writes	Yes	Reset Override	FWH Sector Protection
SMI #-Based Global Write Protection	Writes	No	SMI# Override	Same as Write Protect in previous chipset for FWH

The processor provides these protections in hardware. Note that it is critical that the hardware must not allow malicious software to modify the address or opcode pointers after determining that a cycle is allowed to run, such that the actual cycle that runs on SPI should have been blocked.

If the command associated with an atomic cycle sequence is blocked according to the processor configuration, the processor must not run any of the sequence.

A blocked command will appear to software to finish, except that the Blocked Access Status bit in [Offset 00h: SPIS – SPI Status](#) register is set in this case.

11.9.5.14.1 BIOS Range Write Protection

The processor provides a method for blocking writes to specific ranges in the SPI flash when the Protected BIOS Ranges are enabled. This is achieved by checking the Opcode type information (which can be locked down by the initial Boot BIOS) and the address of the requested command against the base and limit fields of a Write Protected BIOS range.

In order to keep the hardware simple, only the initial address is checked. Since writes wrap within a page, there should be no issue with writes illegally occurring in the next page (assuming the BIOS has configured the Protection Limit to align with the edge of a page).

Note that once BIOS has locked down the Protected BIOS Range registers, this mechanism remains in place until the next system reset.

11.9.5.14.2 SMI # Based Global Write Protection

The processor provides a method for blocking writes to the SPI flash when the Write Protect bit is cleared (i.e., protected) in [Offset D8h: BC: BIOS Control Register](#). This is achieved by checking the Opcode type information (which can be locked down by the initial Boot BIOS) of the requested command.

The Write Protect and Lock Enable bits interact in the same manner for SPI BIOS as they do for the FWH BIOS.

11.9.5.14.3 SPI Flash Address Range Protection

The System Flash (BIOS) occupies the top part of the SPI Flash Memory Device when sharing this space with the Manageability functions. In order to prevent the system from illegally accessing or modifying information in the Manageability areas, the processor checks outgoing addresses with the [Offset 50h: BBAR – BIOS Base Address](#) register and blocks any cycles with addresses below that value. This includes Direct Memory Reads to the SPI flash. In the case of Direct Memory Reads, the processor must return all 1's in the read completion.



Note that once BIOS has locked down the BIOS BAR, this mechanism remains in place until the next system reset.

There is one exception where processor-initiated reads may access data below the BIOS Base Address. If a programmed read (or Direct Memory Read) is initiated at the top of flash such that the length exceeds the top of flash memory, the read burst may wrap around to location 0.

11.9.5.14.4 Decoding Memory Range for SPI

The Boot BIOS Destination straps are sampled on the rising edge of PWROK. The Feature space ranges are unique to the FWH flash. However, the feature space can be treated just like standard memory from an SPI perspective and therefore allow up to 16 MB of contiguous memory decode. The processor forwards both data and feature space ranges to the SPI interface (although the BIOS BAR may block the feature space accesses in situations where the flash size is less than 4 MB). Of course, in order to utilize 16 MB, the single flash device would need to support 128 Mbits of data.

The Top Swap mechanism works in the same way that it does on LPC. Address bit 16 is inverted when Top Swap is enabled for any accesses to the upper two 64 kB blocks. Also like LPC, the Top Swap functionality does not apply to accesses generated to the holes below 1 MB. The SPI interface performs the address bit inversion on only the Direct Memory Read access method; software can control the address directly with the programmed command access method. The prefetching and caching logic consistently comprehends the address inversion to avoid delivering bad data. Also, the protection mechanisms described above observe the address after the inversion logic.

Memory writes to the BIOS memory range are dropped. This simplifies the hardware architecture, and forces all of these potentially harmful cycles to go through the Programmed Commands interface.

Note that Direct Memory Reads to the E0000h-FFFFh segments are remapped to top of flash as mentioned previously in [Section 11.9.5.12.1](#). This range is not remapped when using Programmed Accesses.

11.9.6 SPI Clocking

The SPI clock, when driven by the processor, is derived from the 100 MHz “backbone” clock. The SPI Clock Selection fuse defaults to dividing the 100 MHz clock by 5, resulting in a clock frequency of 20 MHz (50 ns clock period).

Implementation Note: The duty cycle is 40% and 60%.

Note that a DFT divide-by-5 mode is added for determinism with the clock sets planned for the tester.

11.9.7 BIOS Programming Considerations

In general, any Flash update can be broken down into two steps.

1. Erase
2. Write

The Erase process initializes the addressed sector to FFh, erase times for the supported Flash devices are shown below. The atomic instructions that make up the Erase process are a Write enable instruction, an Erase instruction, and finally a status poll.

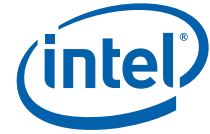
**Table 385. Flash Erase Time**

Device	Erase Time (max)	Description
PMC* PM25LV	100 ms	Same for block or sector
Atmel* AT25F	1.1 s	
SST* SST25VF	25, 25, 100 ms	Sector, block, chip
NexFlash* NX25P	2, 3/5 s	Sector, chip 2 mb/4 mb
ST* M25P80	3 s	Sector

The Write process is executed to write bytes to the Flash device. The atomic instructions that make up the Write process include a Write enable instruction, a Write (or Program) instruction and finally a status poll.

Note that the Write Disable occurs automatically following the completion of the Write opcode in nearly all cases. The processor does not support explicitly disabling writes as part of the Atomic write sequence.

It is recommended that BIOS avoid using instructions that take more than one second to complete inside the flash. See [Section 11.9.5.12.1](#), for details.

11.9.7.1 Run Time Updates

BIOS, especially SMI code, may log errors or record other run-time variables in a section of the flash by writing a few bytes at a time. It is recommended that run time updates be performed to a section of flash that has already been erased and allocated. BIOS keeps a pointer to the next byte to be written and updates the pointer real time as bytes are written. SMI# may optionally be enabled by performing a programmed write with the SPI SMI# Enable bit set to report to software when the update has completed.

Direct memory reads to the SPI flash can encounter long delays. The processor may directly block progress of one or more threads in the system. Therefore, run-time reads are recommended to use the programmed command mechanism and optionally the Software-Based SPI Access Request/Grant mechanism. The programmed command mechanism allows reads to the flash to be generated using posted writes. The completion of the read can be determined by polling the SPI Status register (in the processor) or by receiving an SMI#. With either method, the system is not encountering long delays for a single non-postable cycle to complete on the front-side bus. Host software can read the data out of the data registers when the cycle completes.

11.9.7.2 BIOS Sector Updates

If a large sector of the Flash is to be updated, external SPI bus master will need to be informed through the Future Req protocol to avoid long transactions. The process for updating a sector varies from device to device, some devices will allow up to a 256 byte write while others only allow a byte write at a time. From a processor point of view, software should write up to 64 bytes at a time into the write posting buffer. Data that needs to be preserved should be copied to scratch pad memory and copied in at the respective address.

Software needs to be aware of different sector write algorithms between Flash vendors. For example, SST* Flash does not allow 64 byte writes, it allows byte writes only. Hardware does not split 64 byte writes from the posting buffer; it is software's responsibility to write byte by byte.



The following table shows the different device write times for doing a 512 kB sector write.

Table 386. Flash Write Time

Device	Write Time Worst Case/ Typical	Description
PMC* PM25LV	41/8 s	
Atmel* AT25F	1/.7 s	
SST* SST25VF	~13 s	Two options for byte writes with this device: byte write and byte write with auto address increment. However, only the standard byte write is supported by the processor. The Worst Case time accounts for re-transmission of Write Enable, Write with Address, Read Status, and platform inter- command delay (total of ~5 us).
NexFlash* NX25P	41/16 s	
ST* M25P80	4/11.71 s	
ST* M45P80	41/10 s	

11.9.7.3 SPI Initialization

This section provides a high level description of the steps that the BIOS should take upon coming out of RESET when using SPI Flash.

1. Boot vector fetch and other initial BIOS reads using Direct Memory Reads (some of which are 64 byte code reads). Caching is enabled in hardware by default to improve performance on consecutive reads to the same line.
2. Turn on the SPI Prefetching policy in the LPC Bridge Configuration Space ([Offset D8h: BC: BIOS Control Register](#)). This policy bit is in configuration space to avoid requiring protected memory space early in the boot process.
3. Copy the various BIOS modules out of the SPI Flash using Direct Memory Reads. It is assumed that these reads are shorter than 64 bytes and are targeted to consecutive addresses; hence, the prefetch mechanism improves the performance of this sequence.
4. Turn off the SPI Prefetch policy.
5. Program opcode registers in order to discover which Flash device is being used. Four of the six supported Flash devices support the READ ID instruction. Details of the discovery algorithm are outside the scope of this specification.
6. Disable Future Request, [Offset 02h: SPIC – SPI Control](#) bit 0. Default state is Future Request enabled.
7. Re-program opcode registers to support specific Flash vendor's commands. If not using all of the Opcode Menu and Prefix Opcodes, BIOS should program a "safe" value in the unused opcodes to minimize what malicious software can do. A suggested safe value is to replicate one of the valid entries.
 - a. [Offset 54h: PREOP – Prefix Opcode Configuration](#)
 - b. [Offset 56h: OPTYPE – Opcode Type Configuration](#)
 - c. [Offset 58h: OPMENU – Opcode Menu Configuration](#)
8. Setup protection registers as needed.
 - a. [Offset 50h: BBAR – BIOS Base Address](#)
 - b. [Offset 60h: PBR0 – Protected BIOS Range \[0-2\]](#)
 - c. [Offset 64h: PBR1 – Protected BIOS Range #1](#)
 - d. [Offset 68h: PBR2 – Protected BIOS Range #2](#)

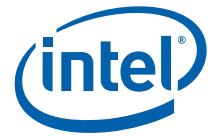

9. Lock down the SPI registers, [Offset 00h: SPIS – SPI Status](#) bit 15
10. Set Up SMI based write protection as needed (same as FWH)

11.10 Watchdog Timer

11.10.1 Overview

This Watchdog timer provides a resolution that ranges from 1 μ s to 10 minutes. The timer uses a 35-bit down-counter.

After the interrupt is generated the WDT loads the value from the Preload register into the WDT's 35-bit Down-Counter and starts counting down. If the host fails to reload the WDT before the timeout, the WDT drives the GPIO[4] pin high and sets the timeout bit (WDT_TIMEOUT). This bit indicates that the System has become unstable. The GPIO[4] pin is held high until the system is Reset or the WDT times out again (Depends on TOUT_CNF). The process of reloading the WDT involves the following sequence of writes:

1. Write "80" to offset BAR1 + 0Ch
2. Write "86" to offset BAR1 + 0Ch
3. Write '1' to WDT_RELOAD in Reload Register.

The same process is used for setting the values in the preload registers. The only difference exists in step 3. Instead of writing a '1' to the WDT_RELOAD, you write the desired preload value into the corresponding Preload register. This value is not loaded into the 35-bit down counter until the next time the WDT reenters the stage. For example, if Preload Value 2 is changed, it is not loaded into the 35-bit down counter until the next time the WDT enters the second stage.

GPIO[4] is used for WDT output (WDT_TOUT) when it is not enabled for GPIO (CGEN[4]=0).

11.10.2 Features

Selectable Prescaler – approximately 1 MHz (1 μ s to 1 s) and approximately 1 KHz (1 ms to 10 min)

- 33 MHz Clock (30 ns Clock Ticks)
- WDT Mode:
 - Drives GPIO[4] high or inverts the previous value.
 - Used only after first timeout occurs.
 - Status bit preserved in RTC well for possible error detection and correction.
 - Drives GPIO[4] if OUTPUT is enabled.
- Timer can be disabled (default state) or Locked (Hard Reset required to disable WDT).

WDT Automatic Reload of Preload value when WDT Reload Sequence is performed.

In WDT mode, users need to program the preload value 1 register to all 0's.

11.10.3 Watchdog Timer Register Details

All registers not mentioned are reserved.

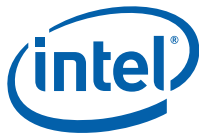

Table 387. Watchdog Timer Register Summary: IA F Base (IO) View

Offset Start	Offset End	Register ID - Description	Default Value
00h	00h	"Offset 00h: PV1R0 - Preload Value 1 Register 0" on page 268	FFh
01h	01h	"Offset 01h: PV1R1 - Preload Value 1 Register 1" on page 269	FFh
02h	02h	"Offset 02h: PV1R2 - Preload Value 1 Register 2" on page 269	0Fh
04h	04h	"Offset 04h: PV2R0 - Preload Value 2 Register 0" on page 270	FFh
05h	05h	"Offset 05h: PV2R1 - Preload Value 2 Register 1" on page 270	FFh
06h	06h	"Offset 06h: PV2R2 - Preload Value 2 Register 2" on page 270	0Fh
0Ch	0Ch	"Offset 0Ch: RR0 - Reload Register 0" on page 271	00h
0Dh	0Dh	"Offset 0Dh: RR1 - Reload Register 1" on page 271	00h
10h	10h	"Offset 10h: WDTCR - WDT Configuration Register" on page 272	00h
14h	14h	"Offset 14h: DCR0 - Down Counter Register 0" on page 272	00h
15h	15h	"Offset 15h: DCR1 - Down Counter Register 1" on page 273	00h
16h	16h	"Offset 16h: DCR2 - Down Counter Register 2" on page 273	00h
18h	18h	"Offset 18h: WDTLR - WDT Lock Register" on page 273	00h

Note: Base Address for the Watchdog Timer registers, listed in this section, is configurable.

11.10.3.1 Offset 00h: PV1R0 - Preload Value 1 Register 0

Table 388. 00h: PV1R0 - Preload Value 1 Register 0

Size: 8 bit		Default: FFh		Power Well: Core
Access		PCI Configuration B:D:F		Offset Start: 00h Offset End: 00h
		IA F Base Address: Base (IO)		Offset: 00h
Bit Range	Default	Access	Acronym	Description
07 : 00	FFh	RW	PLOAD1_7_0	Preload_Value_1 [7:0]: This register is used to hold the bits 0 through 7 of the preload value 1 for the WDT Timer. The Value in the Preload Register is automatically transferred into the 35-bit down counter. The value loaded into the preload register needs to be one less than the intended period. This is because the timer makes use of zero-based counting (i.e. zero is counted as part of the decrement). Refer to Section 11.10.4.2 for details on how to change the value of this register.

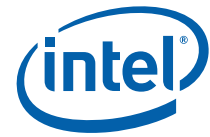

11.10.3.2 Offset 01h: PV1R1 - Preload Value 1 Register 1

Table 389. 01h: PV1R1 - Preload Value 1 Register 1

Size: 8 bit		Default: FFh		Power Well: Core
Access		PCI Configuration B:D:F		Offset Start: 01h Offset End: 01h
		IA F	Base Address: Base (IO)	Offset: 01h
Bit Range	Default	Access	Acronym	Description
07 : 00	FFh	RW	PLOAD1_15_8	Preload_Value_1 [15:8]: This register is used to hold the bits 8 through 15 of the preload value 1 for the WDT Timer. The Value in the Preload Register is automatically transferred into the 35-bit down counter. The value loaded into the preload register needs to be one less than the intended period. This is because the timer makes use of zero-based counting (i.e. zero is counted as part of the decrement). Refer to Section 11.10.4.2 for details on how to change the value of this register.

11.10.3.3 Offset 02h: PV1R2 - Preload Value 1 Register 2

Table 390. 02h: PV1R2 - Preload Value 1 Register 2

Size: 8 bit		Default: FFh		Power Well: Core
Access		PCI Configuration B:D:F		Offset Start: 02h Offset End: 02h
		IA F	Base Address: Base (IO)	Offset: 02h
Bit Range	Default	Access	Acronym	Description
07 : 04	0h		Reserved	Reserved
03 : 00	Fh	RW	PLOAD_19_16	Preload_Value_1 [19:16]: This register is used to hold the bits 16 through 19 of the preload value 1 for the WDT Timer. The Value in the Preload Register is automatically transferred into the 35-bit down counter. The value loaded into the preload register needs to be one less than the intended period. This is because the timer makes use of zero-based counting (i.e. zero is counted as part of the decrement). Refer to Section 11.10.4.2 for details on how to change the value of this register.

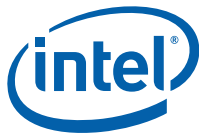

11.10.3.4 Offset 04h: PV2R0 - Preload Value 2 Register 0

Table 391. 04h: PV2R0 - Preload Value 2 Register 0

Size: 8 bit		Default: FFh		Power Well: Core
Access		PCI Configuration B:D:F		Offset Start: 04h Offset End: 04h
		IA F	Base Address: Base (IO)	Offset: 04h
Bit Range	Default	Access	Acronym	Description
07 : 00	FFh	RW	PLOAD2_7_0	Preload_Value_2 [7:0]: This register is used to hold the bits 0 through 7 of the preload value 2 for the WDT Timer. The Value in the Preload Register is automatically transferred into the 35-bit down counter. The value loaded into the preload register needs to be one less than the intended period. This is because the timer makes use of zero-based counting (i.e., zero is counted as part of the decrement). Refer to Section 11.10.4.2 for details on how to change the value of this register.

11.10.3.5 Offset 05h: PV2R1 - Preload Value 2 Register 1

Table 392. 05h: PV2R1 - Preload Value 2 Register 1

Size: 8 bit		Default: FFh		Power Well: Core
Access		PCI Configuration B:D:F		Offset Start: 05h Offset End: 05h
		IA F	Base Address: Base (IO)	Offset: 05h
Bit Range	Default	Access	Acronym	Description
07 : 00	FFh	RW	PLOAD2_15_8	Preload_Value_2 [15:8]: This register is used to hold the bits 8 through 15 of the preload value 2 for the WDT Timer. The Value in the Preload Register is automatically transferred into the 35-bit down counter. The value loaded into the preload register needs to be one less than the intended period. This is because the timer makes use of zero-based counting (i.e., zero is counted as part of the decrement). Refer to Section 11.10.4.2 for details on how to change the value of this register.

11.10.3.6 Offset 06h: PV2R2 - Preload Value 2 Register 2

Table 393. 06h: PV2R2 - Preload Value 2 Register 2 (Sheet 1 of 2)

Size: 8 bit		Default: 0Fh		Power Well: Core
Access		PCI Configuration B:D:F		Offset Start: 06h Offset End: 06h
		IA F	Base Address: Base (IO)	Offset: 06h
Bit Range	Default	Access	Acronym	Description
07 : 04	0h		Reserved	Reserved

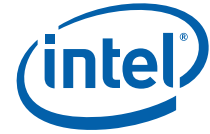

Table 393. 06h: PV2R2 - Preload Value 2 Register 2 (Sheet 2 of 2)

Size: 8 bit		Default: 0Fh		Power Well: Core
Access		PCI Configuration B:D:F		Offset Start: 06h Offset End: 06h
		IA F Base Address: Base (IO)		Offset: 06h
Bit Range	Default	Access	Acronym	Description
03 : 00	Fh	RW	PLOAD2_19_16	Preload_Value_2 [19:16]: This register is used to hold the bits 16 through 19 of the preload value 2 for the WDT Timer. The Value in the Preload Register is automatically transferred into the 35-bit down counter. The value loaded into the preload register needs to be one less than the intended period. This is because the timer makes use of zero-based counting (i.e. zero is counted as part of the decrement). Refer to Section 11.10.4.2 for details on how to change the value of this register.

11.10.3.7 Offset 0Ch: RR0 - Reload Register 0

Table 394. 0Ch: RR0 - Reload Register 0

Size: 8 bit		Default: 00h		Power Well: Core
Access		PCI Configuration B:D:F		Offset Start: 0Ch Offset End: 0Ch
		IA F Base Address: Base (IO)		Offset: 0Ch
Bit Range	Default	Access	Acronym	Description
07 : 00	00h		Reserved	Reserved. Must be programmed to 0.

11.10.3.8 Offset 0Dh: RR1 - Reload Register 1

Table 395. 0Dh: RR1 - Reload Register 1

Size: 8 bit		Default: 00h		Power Well: Core
Access		PCI Configuration B:D:F		Offset Start: 0Dh Offset End: 0Dh
		IA F Base Address: Base (IO)		Offset: 0Dh
Bit Range	Default	Access	Acronym	Description
07 : 02	00h		Reserved	Reserved
01	0h	RWC	TOUT	WDT_TIMEOUT: This bit is located in the RTC Well and it's value is not lost if the host resets the system. It is set to '1' if the host fails to reset the WDT before the 35-bit Down-Counter reaches zero for the second time in a row. This bit is cleared by performing the Register Unlocking Sequence followed by a '1' to this bit. 0 = Normal (Default) 1 = System has become unstable.
00	0h	RW	RELOAD	WDT_RELOAD: To prevent a timeout the host must perform the Register Unlocking Sequence followed by a '1' to this bit. Refer to Section 11.10.4.2 for details on how to change the value of this register.



11.10.3.9 Offset 10h: WDTCR - WDT Configuration Register

Table 396. 10h: WDTCR - WDT Configuration Register

Size: 8 bit		Default: 00h		Power Well: Core
Access		PCI Configuration B:D:F		Offset Start: 10h Offset End: 10h
		IA F Base Address: Base (IO)		Offset: 10h
Bit Range	Default	Access	Acronym	Description
07 : 06	00h	RO	Reserved	Reserved
05	0h	RW	WDT_TOUT_EN	WDT Timeout Output Enable: This bit indicates whether or not the WDT toggles the external GPIO[4] pin if the WDT times out. 0 = Enabled (Default) 1 = Disabled
04	0	RW	WDT_RESET_EN	WDT Reset Enable: When this bit is enable (set to 1), it allows internal reset to be trigger when WDT timeout. It either trigger COLD or WARM reset depend on WDT_RESET_SEL bit. 0 = Disable internal reset (Default) 1 = Enable internal COLD or WARM reset.
03	0h	RW	WDT_RESET_SEL	WDT Reset Select: This determines which reset to be triggered when WDT_RESET_EN is set. 0 = Cold Reset (Default) 1 = Warm Reset
02	0h	RW	WDT_PRE_SEL	WDT Prescaler Select: The WDT provides two options for prescaling the main Down Counter. The preload values are loaded into the main down counter right justified. The prescaler adjusts the starting point of the 35-bit down counter. 0 = The 20-bit Preload Value is loaded into bits 34:15 of the main down counter. The resulting timer clock is the PCI Clock (33 MHz) divided by 2 ¹⁵ . The approximate clock generated is 1 KHz, (1 ms to 10 min). (Default) 1 = The 20-bit Preload Value is loaded into bits 24:05 of the main down counter. The resulting timer clock is the PCI Clock (33 MHz) divided by 2 ⁵ . The approximate clock generated is 1 MHz, (1 μs to 1 sec)
01 : 00	00h	RW	RSVD	Reserved

11.10.3.10 Offset 14h: DCRO - Down Counter Register 0

Table 397. 14h: DCRO - Down Counter Register 0

Size: 8 bit		Default: 00h		Power Well: Core
Access		PCI Configuration B:D:F		Offset Start: 14h Offset End: 14h
		IA F Base Address: Base (IO)		Offset: 14h
Bit Range	Default	Access	Acronym	Description
07 : 00	00h	RO	DCNT_7_0	Down-Counter [7:0]: The Down-Counter register holds the bits 0 through 7 of upper 20-bits of the 35-bit down counter that is continuously decremented. The values from Preload Registers are loaded into the Down-Counter every time the WDT enters stage. The down counter decrements using a 33 MHz clock. Any reads to this register return an indeterminate value. This register is to be indicated as reserved.



11.10.3.11 Offset 15h: DCR1 - Down Counter Register 1

Table 398. 15h: DCR1 - Down Counter Register 1

Size: 8 bit		Default: 00h		Power Well: Core
Access		PCI Configuration B:D:F		Offset Start: 15h Offset End: 15h
		IA F	Base Address: Base (IO)	Offset: 15h
Bit Range	Default	Access	Acronym	Description
07 : 00	00h	RO	DCNT_15_8	Down-Counter [15:8]: The Down-Counter register holds the bits 8 through 15 of upper 20-bits of the 35-bit down counter that is continuously decremented. The values from Preload Registers are loaded into the Down-Counter every time the WDT enters stage. The down counter decrements using a 33 MHz clock. Any reads to this register return an indeterminate value. This register is to be indicated as reserved.

11.10.3.12 Offset 16h: DCR2 - Down Counter Register 2

Table 399. 16h: DCR2 - Down Counter Register 2

Size: 8 bit		Default: 00h		Power Well: Core
Access		PCI Configuration B:D:F		Offset Start: 16h Offset End: 16h
		IA F	Base Address: Base (IO)	Offset: 16h
Bit Range	Default	Access	Acronym	Description
07 : 04	0h		Reserved	Reserved
03 : 00	0h	RO	DCNT_19_16	Down-Counter [19:16]: The Down-Counter register holds the bits 16 through 19 of upper 20-bits of the 35-bit down counter that is continuously decremented. The values from Preload Registers are loaded into the Down-Counter every time the WDT enters the stage. The down counter decrements using a 33 MHz clock. Note: Any reads to this register return an indeterminate value. This register is to be indicated as reserved.

11.10.3.13 Offset 18h: WDTLR - WDT Lock Register

Table 400. 18h: WDTLR - WDT Lock Register (Sheet 1 of 2)

Size: 8 bit		Default: 00h		Power Well: Core
Access		PCI Configuration B:D:F		Offset Start: 18h Offset End: 18h
		IA F	Base Address: Base (IO)	Offset: 18h
Bit Range	Default	Access	Acronym	Description
07 : 03	0h		Reserved	Reserved
02	0h	RW	WDT_TOUT_CN F	WDT Timeout Configuration: This register is used to choose the functionality of the timer. Watchdog Timer Mode: When enabled (i.e. WDT_ENABLE goes from '0' to '1') the timer reloads Preload Value 1 and start decrementing. (Default) Upon reaching timeout the GPIO[4] is driven high once and does not change again until Power is cycled or a hard reset occurs.



Table 400. 18h: WDTLR - WDT Lock Register (Sheet 2 of 2)

Size: 8 bit		Default: 00h		Power Well: Core
Access		PCI Configuration B:D:F		Offset Start: 18h Offset End: 18h
		IA F Base Address: Base (IO)		Offset: 18h
Bit Range	Default	Access	Acronym	Description
01	0h	RW	WDT_ENABLE	<p>Watchdog Timer Enable: The following bit enables or disables the WDT. 0 = Disabled (Default) 1 = Enabled</p> <p>Note: This bit cannot be modified if WDT_LOCK has been set.</p> <p>Note: In WDT mode Preload Value 1 is reloaded every time WDT_ENABLE goes from '0' to '1' or the WDT_RELOAD bit is written using the proper sequence of writes (See Register Unlocking Sequence). When the WDT timeout occurs, a reset must happen.</p> <p>Note: Software must guarantee that a timeout is not about to occur before disabling the timer. A reload sequence is suggested.</p>
00	0h	RWL	WDT_LOCK	<p>Watchdog Timer Lock: Setting this bit locks the values of this register until a hard-reset occurs or power is cycled. 0 = Unlocked (Default) 1 = Locked</p> <p>Note: Writing a "0" has no effect on this bit. Write is only allowed from "0" to "1" once. It cannot be changed until either power is cycled or a hard-reset occurs.</p>

11.10.4 Theory Of Operation

11.10.4.1 RTC Well and WDT_TOUT Functionality

The WDT_TIMEOUT bit is set to a '1' when the WDT 35-bit down counter reaches zero for the second time in a row. Then the GPIO[4] pin is toggled HIGH by the WDT from the processor. The board designer must attach the GPIO[4] to the appropriate external signal. If WDT_TOUT_CNF is a '1' the WDT toggles WDT_TOUT (GPIO[4]) again the next time a time out occurs. Otherwise GPIO[4] is driven high until the system is reset or power is cycled.

11.10.4.2 Register Unlocking Sequence

The register unlocking sequence is necessary whenever writing to the RELOAD register or either PRELOAD_VALUE registers. The host must write a sequence of two writes to offset BAR1 + 0Ch before attempting to write to either the WDT_RELOAD and WDT_TIMEOUT bits of the RELOAD register or the PRELOAD_VALUE registers. The first writes are "80" and "86" (in that order) to offset BAR1 + 0Ch. The next write is to the proper memory mapped register (e.g., RELOAD, PRELOAD_VALUE_1, PRELOAD_VALUE_2). Any deviation from the sequence (writes to memory-mapped registers) causes the host to have to restart the sequence.

When performing register unlocking, software must issue the cycles using byte access only. Otherwise the unlocking sequence will not work properly.

The following is an example of how to prevent a timeout:

1. Write "80" to offset BAR1 + 0Ch
2. Write "86" to offset BAR1 + 0Ch
3. Write a '1' to RELOAD [8] (WDT_RELOAD) of the Reload Register

Note: Any subsequent writes require that this sequence be performed again.



11.10.4.3 Reload Sequence

To keep the timer from causing an interrupt or driving GPIO[4], the timer must be updated periodically. Other timers refer to “updating the timer” as “kicking the timer”. The frequency of updates required is dependent on the value of the Preload values. To update the timer the Register Unlocking Sequence must be performed followed by writing a ‘1’ to bit 8 at offset BAR1 + 0Ch within the watchdog timer memory mapped space. This sequence of events is referred to as the “Reload Sequence”.

11.10.4.4 Low Power State

The Watchdog Timer does not operate when PCICLK is stopped.

§ §



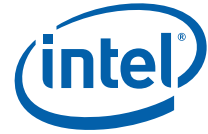

12.0 Absolute Maximum Ratings

Table 401 specifies absolute maximum and minimum ratings. Within functional operation limits, functionality and long-term reliability can be expected. At conditions outside functional operation condition limits, but within absolute maximum and minimum ratings, neither functionality nor long term reliability can be expected. If a device is returned to conditions within functional operation limits after having been subjected to conditions outside these limits, but within the absolute maximum and minimum ratings, the device may be functional, but with its lifetime degraded depending on exposure to conditions exceeding the functional operation condition limits.

At conditions exceeding absolute maximum and minimum ratings, neither functionality nor long term reliability can be expected. Moreover, if a device is subjected to these conditions for any length of time then, when returned to conditions within the functional operating condition limits, it will either not function or its reliability will be severely degraded.

Although the processor contains protective circuitry to resist damage from static electric discharge, precautions should always be taken to avoid high static voltages or electric fields.

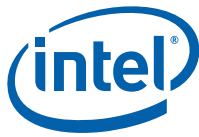

12.1 Absolute Maximum Rating

Table 401. Absolute Maximum Ratings

Symbol	Parameter	Min	Max	Unit	Notes
T _{STORAGE}	The non-operating device storage temperature.	-25	125	°C	1, 2, 3
T _{SUSTAINED STORAGE}	The ambient storage temperature limit (in shipping media) for a sustained period of time.	-5	40	°C	4, 5
RH _{SUSTAINED STORAGE}	The maximum device storage relative humidity for a sustained period of time.	60% @ 24		°C	5, 6
TIME _{SUSTAINED STORAGE}	A prolonged or extended period of time; typically associated with customer shelf life.	0	6	months	6
V _{CC}	Processor Core Supply Voltage	-0.5	2.1	V	
V _{NN}	North Cluster Logic and Graphics Supply Voltage	-0.5	2.1	V	
V _{CCP}	1.05 V Supply Voltage (DMI, Fuses, DDR digital, DPPLL, PCIe* IO, SDVO DPPLL, SDVO pads, HPLL)	-0.5	2.1	V	
V _{CCDSUS}	1.05 V Core Suspend Rail	-0.5	2.1	V	
V _{LVD_VBG}	1.25 V LVDS External Voltage Ref	-0.5	2.1	V	
V _{CCA}	1.5 V Sensors, Core PLL, Core Thermal Sensors Voltages	-0.5	2.1	V	
V _{CCD180}	1.8 V Supply Voltage (LVDS Digital / Analog, DDR I/O, super filter regulators)	-0.3	2.3	V	
V _{CCD180SR}	1.8 V Supply Voltage (DDR SR)	-0.3	2.3	V	
V _{CCP33}	3.3 V Supply Voltage (Legacy IO, SDVO pads, RTC well)	-0.5	4.6	V	
V _{CCP33SUS}	3.3 V Supply Voltage (Suspend Power supply)	-0.5	4.6	V	
V _{MM}	1.05 V Supply Voltage	-0.5	2.1	V	

Notes:

1. Refer to a component device that is not assembled in a board or socket that is not to be electrically connected to a voltage reference or I/O signals.
2. Specified temperatures are based on data collected. Exceptions for surface mount reflow are specified in by applicable JEDEC standard and MAS document. Non-adherence may affect component reliability.
3. T_{storage} applies to the unassembled component only and does not apply to the shipping media, moisture barrier bags or desiccant.
4. Intel® branded board products are certified to meet the following temperature and humidity limits that are given as an example only (Non-Operating Temperature Limit: -40 °C to 70 °C & Humidity: 50% to 90%, non-condensing with a maximum wet bulb of 28 °C). Post board attach storage temperature limits are not specified for non-Intel® branded boards.
5. The JEDEC, J-JSTD-020 moisture level rating and associated handling practices apply to all moisture sensitive devices removed from the moisture barrier bag.
6. Nominal temperature and humidity conditions and durations are given and tested within the constraints imposed by T_{SUSTAINED} and customer shelf life in applicable Intel® box and bags.





13.0 DC Characteristics

13.1 Signal Groups

The signal description includes the type of buffer used for the particular signal. Please refer to the [Chapter 2.0](#) for signals detail.

Table 402. Memory Controller Buffer Types

Buffer Type	Description
AGTL+	Assisted Gunning Transceiver Logic Plus. Open Drain interface signals that require termination. Refer to the AGTL+ I/O Specification for complete details.
CMOS, CMOS Open Drain	1.05-V CMOS buffer
CMOS_HDA	CMOS buffers for Intel® HD Audio ^β interface, 3.3-V operation.
CMOS1.8	1.8-V CMOS buffer. These buffers can be configured as Stub Series Termination Logic (SSTL1.8)
CMOS3.3, CMOS3.3 Open Drain	3.3-V CMOS buffer
CMOS3.3-5	3.3-V CMOS buffer, 5-V tolerant
PCIe*	PCI Express* interface signals. These signals are compatible with <i>PCI Express* Base Specification</i> , Rev. 1.0a Signaling Environment AC Specifications and are AC coupled. The buffers are not 3.3-V tolerant. Differential voltage specification = $(D+ - D-) \times 2 = 1.2 V_{max}$. Single-ended maximum = 1.5 V. Single-ended minimum = 0 V.
SDVO	Serial-DVO differential output buffers. These signals are AC coupled.
LVDS	Low Voltage Differential Signal buffers. These signals should drive across a 100-Ohm resistor at the receiver when driving.
Analog	Analog reference or output. Can be used as a threshold voltage or for buffer compensation.

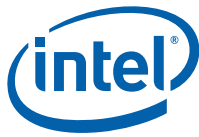

13.2 Power and Current Characteristics

Table 403. Thermal Design Power

Symbol	Parameter	Range	Unit	Notes
TDP_UL	Thermal Design Power (Ultra-Low SKU) (at 1.05-V Core Voltage)	3.3	W	2
TDP_E	Thermal Design Power (Entry SKU) (at 1.05-V Core Voltage)	3.6	W	1
TDP_M	Thermal Design Power (Mainstream SKU) (at 1.05-V Core Voltage)	3.6	W	1
TDP_P	Thermal Design Power (Premium SKU) (at 1.05-V Core Voltage)	4.5	W	2

Notes:

- This spec is the Thermal Design Power and is the measured power generated in a component by a realistic application. It does not represent the expected power generated by a power virus. Studies by Intel indicate that no application will cause thermally significant power dissipation exceeding this specification, although it is possible to concoct higher power synthetic workloads that write but never read. Under realistic read/write conditions, this higher power workload can only be transient and is accounted in the AC (max) spec.
- TDP for E620, E620T, E680 and E680T are estimates.

Table 404. DC Current Characteristics

Symbol	Parameter	Signal Names	Max ^{1,2}	Unit	Notes
I _{VCC}	Core Supply Voltage	VCC	3500	mA	1
I _{VNN}	North Cluster Logic and Graphics Supply Voltage	VNN	1600	mA	1
I _{VCCP}	1.05 V Supply Voltage (DMI, Fuses, DDR digital, DPLL, PCIe* IO, SDVO DPLL, SDVO pads, HPLL)	VCCP, VCCF, VCCPQ, VCCPDDR, VCCPA, VCCQ, VCCD, VCCD_DPL, VCCA_PEG, VCCQHPLL, VCCFHV	3382	mA	1
I _{VCCDSUS}	1.05 V Core Suspend Rail	VCCDSUS	100	mA	1
I _{LVD_VBG}	1.25 V LVDS External Voltage Ref	LVD_VBG	2	mA	1
I _{VCCA}	1.5 V Sensors, Core PLL, Core Thermal Sensors Voltages	VCCA	120	mA	1
I _{VCCD180}	1.8 V Supply Voltage (LVDS Digital / Analog, DDR I/O, super filter regulators)	VCCD180, VCCA180, VCC180, VCCSFR_EXP, VCCSFRDPLL, VCCSFRHPLL	570	mA	1
I _{VCCD180SR}	1.8 V Supply Voltage (DDR SR)	VCCD180SR	15	mA	1
I _{VCCP33}	3.3 V Supply Voltage (Legacy IO, SDVO pads, RTC well)	VCCP33, VCC33RTC	105	mA	1
I _{VCCP33SUS}	3.3 V Supply Voltage (Suspend Power supply)	VCCP33SUS, VCCPSUS	20	mA	1
I _{VMM}	1.05 V Supply Voltage	VMM	5	mA	1

Notes:

- These values are based on post-silicon validated result.
- I_{CCMAX} is determined on a per-interface basis, and all cannot happen simultaneously.



13.3 General DC Characteristics

Table 405. Operating Condition Power Supply and Reference DC Characteristics

Symbol	Parameter	Min.	Typ.	Max.	Unit	Notes
V _{CC} HFM	V _{CC} @ Highest Frequency Mode	AVID	-	1.15	V	1,2,3
V _{CC} LFM	V _{CC} @ Lowest Frequency Mode	0.75	-	AVID	V	1,2,3
V _{CC} C6 VID	V _{CC} @ C6 CPU State		0.3		V	1,3
VCC BOOT	Default VCC for initial power	-	V _{CC} LFM	-	V	1,2,3
VNN BOOT	Default VNN for initial power	-	VNN	-	V	1,2,3
VNN	VNN Supply Voltage	0.75	-	0.9875	V	1,2,3
VCCP, VCCF, VCCPQ, VCCPDDR, VCCPA, VCCQ, VCCD, VCCD_DPL, VCCA_PEG, VCCQHPLL, VCCFHV	1.05 V Supply Voltage (DMI, Fuses, DDR digital, DPLL, PCIe* IO, SDVO DPLL, SDVO pads, HPLL)	0.9975	1.05	1.1025	V	
VCCDSUS	1.05 V Core Suspend Rail	0.9975	1.05	1.1025	V	
LVD_VBG	1.25 V LVDS External Voltage Ref	1.1875	1.25	1.3125	V	
VCCA	1.5 V Sensors, Core PLL, Core Thermal Sensors Voltages	1.425	1.5	1.575	V	
VCCD180, VCCA180, VCC180, VCCSFR_EXP, VCCSFRDPLL, VCCSFRHPLL, VCC180SR	1.8 V Supply Voltage (LVDS Digital / Analog, DDR I/O, super filter regulators)	1.71	1.8	1.89	V	
VCCP33, VCCP33SUS, VCCPSUS,	3.3 V Supply Voltage (Legacy IO, SDVO pads, Suspend Power supply, RTC suspend, RTC well)	3.135	3.3	3.465	V	
VCC33RTC	2.9 V Supply Voltage (RTC well)	2.0 (battery mode)	2.9	3.045	V	
VCCRTCEXT	1.24 V Supply Voltage (RTC well)	1.178	1.24	1.302	V	
VMM	1.05 V Supply Voltage	0.9975	1.05	1.1025	V	

Notes:

- Slew Rate for VCC is 8.75mV/us and slew rate for VNN is 10mV/us.
- Each processor is programmed with a maximum valid voltage identification value (VID), which is set at manufacturing and cannot be altered. Individual maximum VID values are calibrated during manufacturing such that two processors at the same frequency may have different settings within the VID range. Typical VID (voltage identification) range is 0.75–1.15V for VCC (excluding VCC C6 VID) and 0.75V to 0.9875V for VNN. The VID will change due to temperature changes and thermal management event in order to reduce the junction temperature of the part.

Table 406. Active Signal DC Characteristics (Sheet 1 of 4)

Symbol	Parameter	Min	Nom	Max	Unit	Notes
CMOS1.05						
V _{IL}	Input Low Voltage	-0.1	0.0	0.2 x V _{CCD}	V	
V _{IH}	Input High Voltage	0.8 x V _{CCD}	V _{CCD}	V _{CCD} + 0.1	V	
V _{OL}	Output Low Voltage	-0.1	0	0.1 x V _{CCD}	V	



Table 406. Active Signal DC Characteristics (Sheet 2 of 4)

Symbol	Parameter	Min	Nom	Max	Unit	Notes
V _{OH}	Output High Voltage	0.9 x V _{CCD}	V _{CCD}	V _{CCD} + 0.1	V	
I _{OL}	Output Low Current	1.5		4.1	mA	
I _{OH}	Output High Current	1.5		4.1	mA	
I _{IL}	Input Low Current			± 100	µA	
C _{pad}	Pad Capacitance	0.95	1.2	1.45	pF	
CMOS1.05 Open Drain						
V _{OL}	Output Low Voltage	0		0.35	V	
V _{OH}	Output High Voltage	V _{CCD} - 5%	1.05	V _{CCD} + 5%	V	
I _{OL}	Output Low Current	16		50	mA	
I _{OH}	Output High Current			± 200	µA	
C _{pad}	Pad Capacitance	1.9	2.2	2.45	pF	
CMOS3.3, CMOS3.3 Open Drain						
V _{IL}	Input Low Voltage			0.8	V	
V _{IH}	Input High Voltage	2			V	
V _{OL}	Output Low Voltage			0.4	V	
V _{OH}	Output High Voltage	2.4			V	
I _{OL} for CMOS3.3	Output Low Current			8	mA	
I _{OH} for CMOS3.3	Output High Current			-8	mA	
I _{OL} for CMOS3.3 Open Drain	Output Low Current			8	mA	
I _{LEAK}	Input Leakage Current			20	µA	
C _{IN}	Input Capacitance	1		3.5	pF	
V _{CCX}	Supply Voltage	-0.25	3.3	3.96	V	12, 13
CMOS_HDA						
V _{IL}	Input Low Voltage			0.35 V _{CCP33}	V	
V _{IH}	Input High Voltage	0.65 V _{CCP33}			V	
V _{OL}	Output Low Voltage			0.10 V _{CCP33}	V	
V _{OH}	Output High Voltage	0.9 V _{CCP33}			V	
I _{LEAK}	Input Leakage Current			20	µA	
C _{IN}	Input Capacitance			7.5	pF	
System Memory (CMOS1.8)						
V _{IL}	Input Low Voltage	-0.4		(V _{CC180/2}) - 0.125	V	
V _{IH}	Input High Voltage	(V _{CC180/2}) + 0.125		1.9	V	



Table 406. Active Signal DC Characteristics (Sheet 3 of 4)

Symbol	Parameter	Min	Nom	Max	Unit	Notes
V _{OL}	Output Low Voltage			(VCC180/2) – 0.250	V	
V _{OH}	Output High Voltage	(VCC180/2) + 0.250			V	
PCIe*						
V _{TX-DIFF P-P}	Differential Peak to Peak Output Voltage	0.8		1.2	V	6
V _{TX-CM-ACp}	AC Peak Common Mode Output Voltage			20	mV	6
Z _{TX-DIFF-DC}	DC Differential TX Impedance	80	100	120	Ω	
V _{RX-DIFF p-p}	Differential Input Peak to Peak Voltage	0.175		1.2	V	
V _{RX-CM-ACp}	AC peak Common Mode Input Voltage			150	mV	
SDVO						
V _{TX-DIFF P-P}	Differential Peak to Peak Output Voltage	0.8		1.2	V	
V _{TX-CM-ACp}	AC Peak Common Mode Output Voltage			20	mV	
Z _{TX-DIFF-DC}	DC Differential TX Impedance	80	100	120	Ω	
V _{RX-DIFF p-p}	Differential Input Peak to Peak Voltage	0.175		1.2	V	
V _{RX-CM-ACp}	AC peak Common Mode Input Voltage			150	mV	
LVDS						
V _{OD}	Differential Output Voltage	250	350	450	mV	
ΔV _{OD}	Change in V _{OD} between Complementary Output States			50	mV	
V _{OS}	Offset Voltage	1.125	1.25	1.375	V	
ΔV _{OS}	Change in V _{OS} between Complementary Output States			50	mV	
I _{sc}	Short Circuit Current			24	mA	
I _{soc}	Short Circuit Common Current			24	mA	
	Dynamic Offset			150	mV	
	Ringback	50	70	90	mV	
Differential Clocks						
V _{SWING}	Input swing	300			mV	7, 8
V _{CROSS}	Crossing point	300		550	mV	7, 9, 10, 11
V _{CROSS_VAR}	V _{CROSS} Variance			140	mV	7, 9, 10, 11
V _{IH}	Maximum input voltage			1.15	V	7, 9, 12
V _{IL}	Minimum input voltage	-0.3			V	7, 9, 13



Table 406. Active Signal DC Characteristics (Sheet 4 of 4)

Symbol	Parameter	Min	Nom	Max	Unit	Notes
RTCST#,PWROK,RSMRST#						
V _{IH}	Input high voltage	2.17		VCC33RTC + 0.5	V	
V _{IL}	Input low voltage	-0.5		0.68	V	
RTCX1						
V _{IH}	Input high voltage	0.5		1.2	V	
V _{IL}	Input low voltage	-0.5		0.1	V	

Notes:

1. $V_{OL} < V_{PAD} < V_{TT}$
2. For CMOS Open Drain signals defined in Table 406, V_{OH}, V_{OL}, and I_{LEAK} DC specs are not applicable due to the pull-up/pull-down resistor that is required on the board.
3. BSEL2, CFG[1:0] and TCK signals reference VCC, not VTT.
4. At VCC180 = 1.7 V.
5. Specified at the measurement point into a timing and voltage compliance test load as shown in Transmitter compliance eye diagram of PCI Express* specification and measured over any 250 consecutive TX UI's. Specified at the measurement point and measured over any 250 consecutive ULS. The test load shown in receiver compliance eye diagram of PCI Express* specification. Should be used as the RX device when taking measurements.
6. Applicable to the following signals: PCIE_CLKINN/P
7. Measurement taken from differential waveform.
8. Measurement taken from single ended waveform.
9. V_{CROSS} is defined as the voltage where Clock = Clock_B.
10. Only applies to the differential rising edge (i.e., Clock rising and Clock_B falling)
11. The total variation of all V_{CROSS} measurements in any particular system. This is a subset of V_{CROSS}MIN / V_{CROSS}max (V_{CROSS} absolute) allowed. The intent is to limit V_{CROSS} induced modulation by setting V_{CROSS}_VAR to be smaller than V_{CROSS} absolute.
12. The max voltage including overshoot.
13. The min voltage including undershoot.

§ §



14.0 Ballout and Package Information

The Intel® Atom™ Processor E6xx Series comes in an 22 mm x 22 mm Flip-Chip Ball Grid Array (FCBGA) package and consists of a silicon die mounted face down on an organic substrate populated with 676 solder balls on the bottom side. Capacitors may be placed in the area surrounding the die. Because the die-side capacitors are electrically conductive, and only slightly shorter than the die height, care should be taken to avoid contacting the capacitors with electrically conductive materials. Doing so may short the capacitors and possibly damage the device or render it inactive.

The use of an insulating material between the capacitors and any thermal solution should be considered to prevent capacitor shorting. An exclusion, or keep out zone, surrounds the die and capacitors, and identifies the contact area for the package. Care should be taken to avoid contact with the package inside this area.

Refer to the *Intel® Atom™ Processor E6xx Series Thermal and Mechanical Design Guidelines* for details on package mechanical dimensions and tolerance, as well as other key package attributes.

Dimensions:

- Package parameters: 22 mm x 22 mm
- Ball Count: 676
- Land metal diameter: 500 microns
- Solder resist opening: 430 microns

Tolerances:

- .X - ± 0.1
- .XX - ± 0.05
- Angles - ± 1.0 degrees

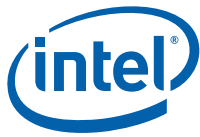

14.1 Package Diagrams

Figure 10. Intel® Atom™ Processor E6xx Series Silicon and Die Side Capacitor (Top View)

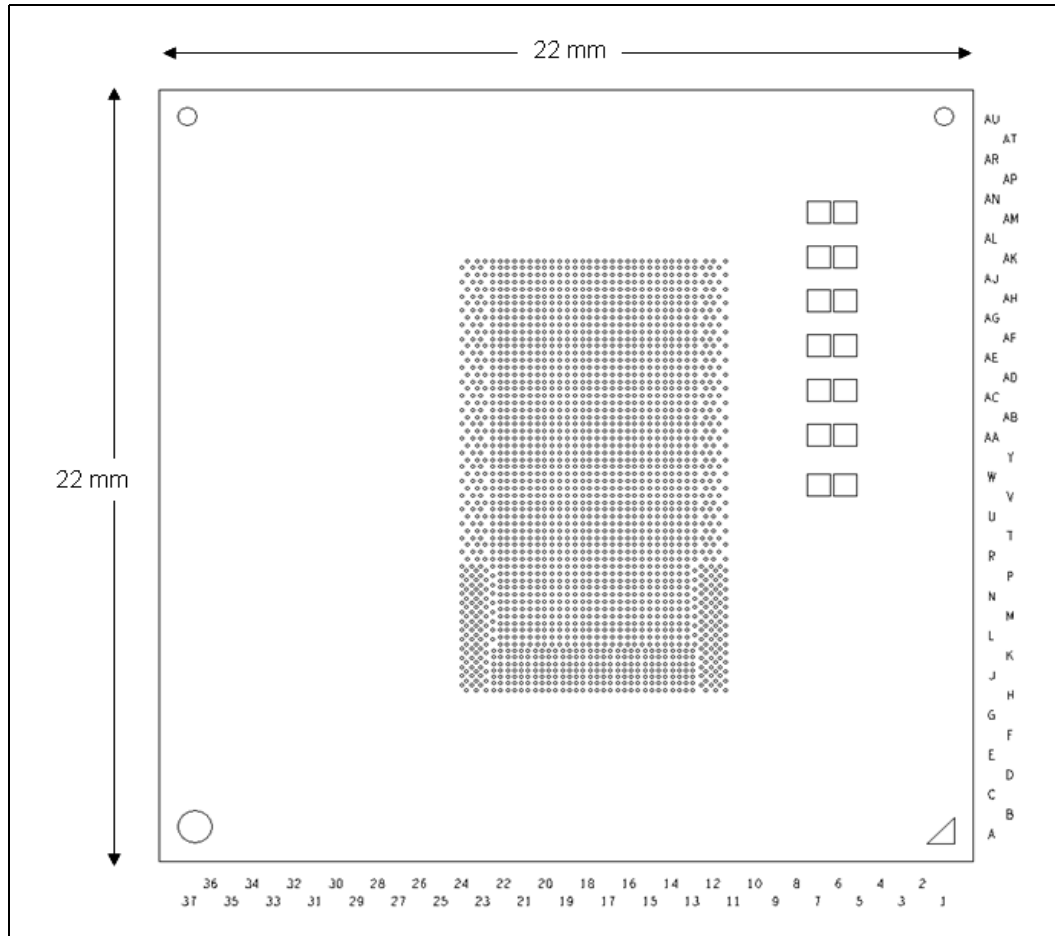
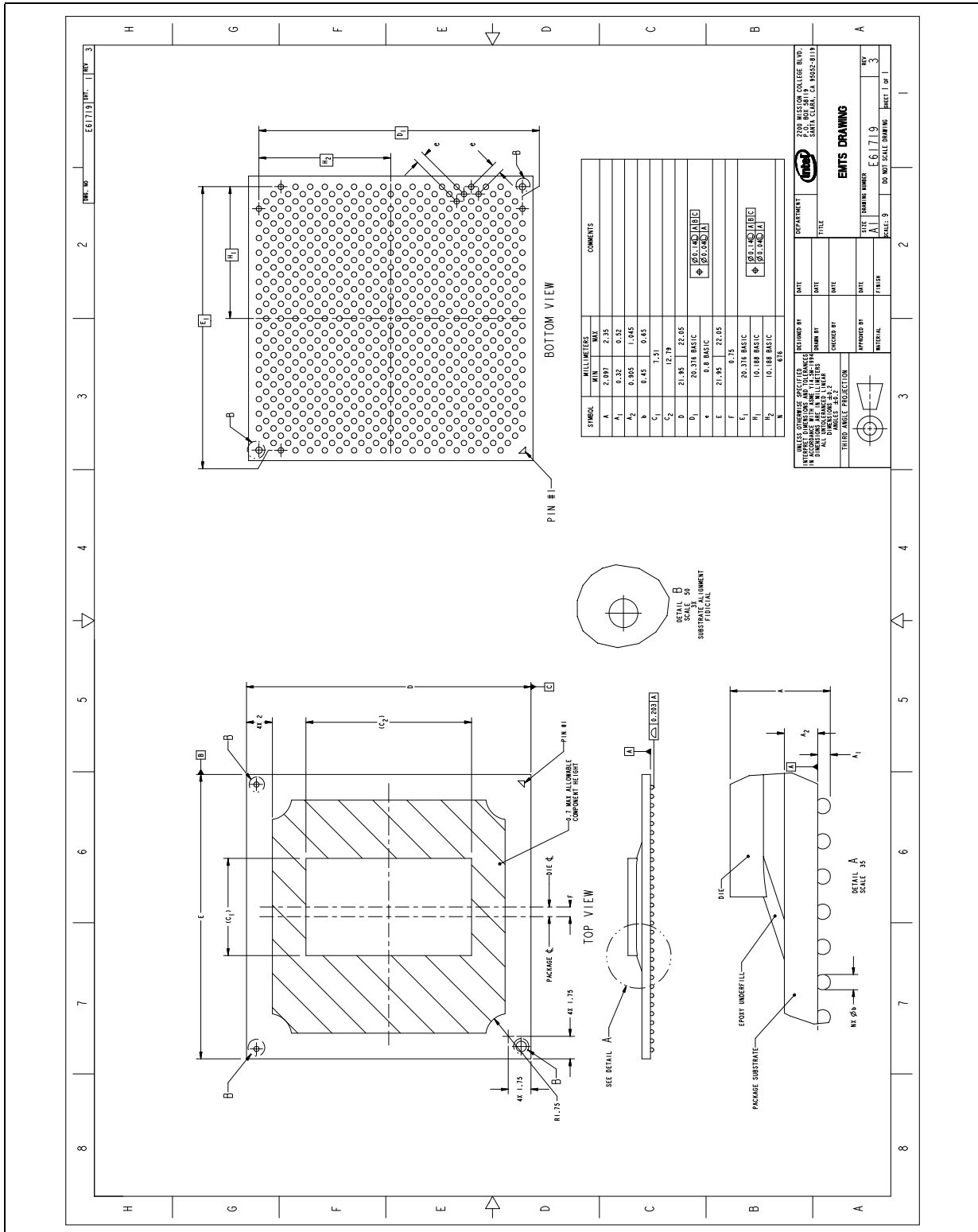
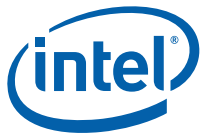



Figure 11. Intel® Atom™ Processor E6xx Series Package Dimensions





14.2 Ballout Definition and Signal Locations

Figure 12 provides the ballout as viewed from the top of the package. Table 407 lists the ballout alphabetically by signal name.

Figure 12. Intel® Atom™ Processor E6xx Series Package Ball Pattern

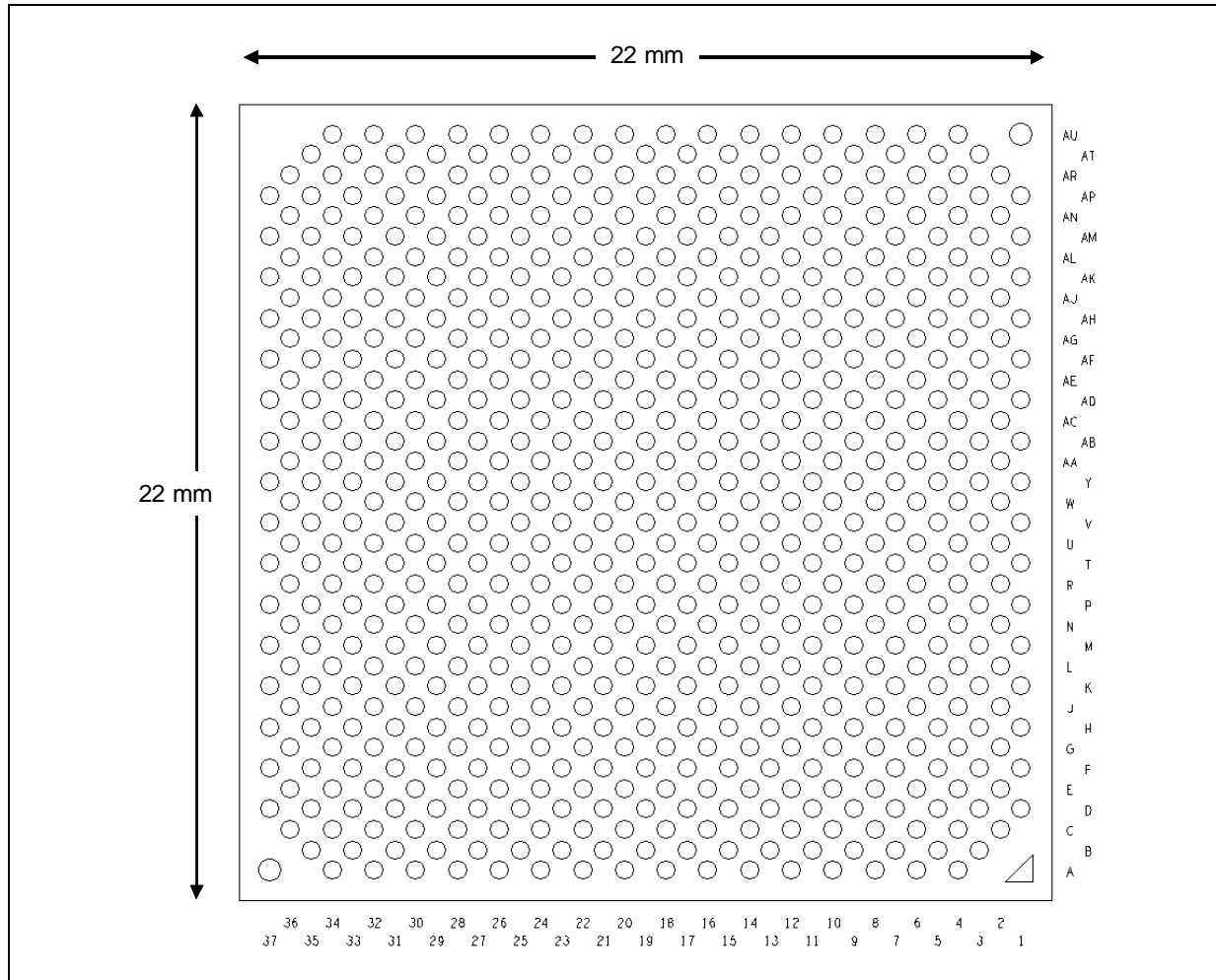

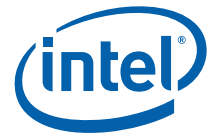

Figure 13. Intel® Atom™ Processor E6xx Series Ball Map (Sheet 1 of 5)

	9	8	7	6	5	4	3	2	1
AU		M_CKP		M_DQ[8]		VSS			
AT	M_SRFWEN		M_CKN		M_DQS[1]		VSS		
AR		VSS		VSS		M_DQ[10]		VSS	
AP	M_DQ[25]		M_MA[5]		M_DQ[13]		VSS		VSS
AN		M_DQ[24]		VSS		M_MA[2]		M_MA[4]	
AM	VSS		M_CKE[1]		M_DQ[14]		VSS		M_BS[1]
AL		NC		VSS		M_DQ[9]		M_BS[2]	
AK	VSS		M_CKE[0]		M_DQ[12]		VSS		M_DQ[0]
AJ		M_MA[14]		VSS		M_DQ[11]		M_DQ[2]	
AH	VCC180		M_MA[6]		M_DQ[15]		VSS		M_DQ[3]
AG		M_MA[11]		VSS		M_DQ[4]		M_DM[0]	
AF	VSS		M_MA[9]		M_DM[1]		VSS		M_DQ[1]
AE		M_RCOMPOUT		VSS		M_DQ[5]		VSS	
AD	VSS		M_RCVENOUT		M_MA[12]		VSS		IO_TDO
AC		M_RCVENIN		VSS		M_DQ[7]		IO_TDI	
AB	VSS		M_MA[8]		M_BS[0]		VSS		IO_TMS
AA		M_MA[0]		VSS		M_DQ[6]		RTCST_B	
Y	VSS		M_MA[3]		M_DQS[0]		VSS		PWROK
W		M_MA[7]		VSS		HPLL_REFCLK_N		HIGHZ_B	
V	VSS		VSS		HPLL_REFCLK_P		VSS		RSMRST_B
U		VSS		VSS		IO_RX_CVREF		IO_RX_GVREF	
T	VSS		VSS		IOCOMP1[0]		VSS		IO_TCK
R		VSS		IOCOMP1[1]		NC		IO_TRST_N	
P	VSS		VSS		VSS		VSS		GPIO_SUS[2]
N		VSS		VSS		GPIO_SUS[1]		GPE_B	
M	VSS		RTCX2		SLPMODE		GPIO_SUS[3]		GPIO_SUS[5]
L		RTCX1		VSS		RSTWARN		GPIO_SUS[6]	
K	VSS		RSTRDY_B		RESET_B		VSS		SLPRDY_B
J		CLK14		VSS		GPIO_SUS[7]		SUSCLK	
H	VSS		SMI_B		SPI_CS_B		TEST_B		GPIO_SUS[8]
G		LPC_AD[2]		VSS		NC		SPKR	
F	VSS		SMB_ALERT_B		SPI_SCK		VSS		SPI_MOSI
E		LPC_SERIRQ		GPIO[0]		SMB_CLK		SPI_MISO	
D		LPC_CLKOUT[1]		LPC_CLKRUN_B		GPIO[3]		LPC_AD[1]	VSS
C		VSS		VSS		GPIO[1]		VSS	
B	NC		SDVO_CTRLDATA		GPIO[4]		VSS		
A		NC		GPIO[2]		VSS			

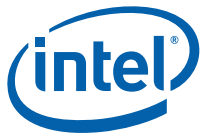

Figure 14. Intel® Atom™ Processor E6xx Series Ball Map (Sheet 2 of 5)

	16	15	14	13	12	11	10
AU	M_DQ[16]		M_DQS[3]		M_DQ[26]		M_MA[13]
AT		M_DQ[31]		M_WEB		M_DQ[27]	
AR	VSS		VSS		VSS		VSS
AP		M_DQS[2]		M_DM[3]		M_DQ[28]	
AN	TDI		M_CSB[0]		M_ODT[1]		M_DQ[29]
AM		VSS		VSS		VSS	
AL	TMS		TRST_B		VSS		M_DQ[30]
AK		VCCP		VCC180		M_ODT[0]	
AJ	VCCPQ		VCC180		M_CSB[1]		M_RASB
AH		VCC180		VCC180		VCC180	
AG	VSS		VSS		VCC180		VSS
AF		VSS		VCCPDDR		VSS	
AE	VSS		VSS		VCCPDDR		VSS
AD		VCC180		VSS		VSS	
AC	VSS		VCCA		VCCPDDR		VSS
AB		VSS		VCC180SR		VSS	
AA	VCC180		VSS		VSS		M_MA[1]
Y		VCC180		VSS		VSS	
W	VCC180		VSS		VCCPDDR		M_MA[10]
V		VSS		VCCPDDR		VSS	
U	VCC180		VCC180		VSS		VSS
T		VCC180		VCC180		VSS	
R	VCC180		VSS		VSS		VSS
P		VCCP		VSS		VCCQ	
N	VSS		VSS		VCCPSUS		VSS
M		VCCSFRHPLL		VCC33RTC		VSS	
L	VSS		VSS		VCCRTCEXT		GPIO_SUS[0]
K		VCCDSUS		VCCP33SUS		GPIO_SUS[4]	
J	VCCP33		VSS		VSS		VSS
H		VSS		VSS		WAKE_B	
G	VSS		SMB_DATA		LPC_AD[3]		THRM_B
F		VSS		VSS		VSS	
E	NC		SDVO_CTRLCLK		LPC_CLKOUT[0]		LPC_CLKOUT[2]
D		NC		LPC_AD[0]		LPC_FRAME_B	
C	VSS		VSS		VSS		VSS
B		SDVO_TVCLKINP		SDVO_CLKP		SDVO_REFCLKP	
A	SDVO_REDN		SDVO_TVCLKINN		SDVO_CLKN		SDVO_REFCLKN



Figure 15. Intel® Atom™ Processor E6xx Series Ball Map (Sheet 3 of 5)

	23	22	21	20	19	18	17
AU		M_DQ[20]		M_DM[2]		M_DQ[17]	
AT	M_DQ[21]		M_DQ[19]		M_DQ[22]		M_DQ[18]
AR		VSS		VSS		VSS	
AP	GTLVREF		BSEL[1]		GPIO_B		M_CASB
AN		TCK		VSS		TDO	
AM	VSS		VSS		VSS		VSS
AL		NCTDI		NC		NC	
AK	PWRMODE[0]		NC		NC		NC
AJ		VCCSENSE		VCCA		VNN	
AH	VSS		VCC_VSSSENSE		VSS		VSS
AG		VCC		VNNSENSE		VNN	
AF	VSS		VSS		VSS		VSS
AE		VCC		VNN		VNN	
AD	VSS		VSS		VSS		VSS
AC		VCC		VNN		VNN	
AB	VSS		VSS		VSS		VSS
AA		VCC		VNN		VNN	
Y	VSS		VSS		VSS		VSS
W		VCC		VNN		VNN	
V	VSS		VSS		VSS		VSS
U		VCC		VNN		VNN	
T	VMM		VSS		VSS		VSS
R		VCC		VNN		VNN	
P	VSS		VSS		VCCFHV		VCC180
N		VCCD		VCCDSENSE		VCCQHPLL	
M	VSS		VSS		VCCD_VSSSENSE		VSS
L		VCCD		VCCD		VCCD	
K	VCCA_PEG		VCCA_PEG		VCCD_DPL		VCCP33
J		VCCA_PEG		VCCA_PEG		VCCA_PEG	
H	VSS		VSS		VCCSFR_EXP		VCCSFRDPLL
G		VSS		VSS		VSS	
F	VSS		VSS		VSS		VSS
E		PCIE_RBIAS		SDVO_STALLP		SDVO_BLUEP	
D	NC		NC		SDVO_STALLN		SDVO_BLUEN
C		VSS		VSS		VSS	
B	PCIE_ICOMPI		SDVO_INTP		SDVO_GREENN		SDVO_REDP
A		NC		SDVO_INTN		SDVO_GREENP	



Figure 16. Intel® Atom™ Processor E6xx Series Ball Map (Sheet 4 of 5)

	30	29	28	27	26	25	24
AU	NCTDO		THERMTRIP_B		BCLKN		M_DQ[23]
AT		VID[1]		PROCHOT_B		BCLKP	
AR	VSS		VSS		VSS		VSS
AP		VID[3]		NCTMS		BSEL[2]	
AN	NC		NCTCK		PWRMODE[1]		NC
AM		VSS		VSS		VCCF	
AL	GTLPPREF		VID[2]		VIDEN[1]		PWRMODE[2]
AK		VSS		VIDEN[0]		VCCPA	
AJ	COMP0[0]		VSS		VCCP		VSS
AH		VSS		VSS		VSS	
AG	NC		VSS		VCCP		VCC
AF		VSS		VCCQ		VSS	
AE	NC		VSS		VSS		VCC
AD		VSS		VSS		VSS	
AC	NC		VSS		VCCP		VCC
AB		VSS		VSS		VCCA	
AA	NC		VSS		VSS		VCC
Y		VSS		VSS		VSS	
W	NC		VSS		VCCP		VCC
V		VSS		VSS		VSS	
U	LVD_DATAP_1		VSS		VCCPA		VCC
T		VSS		VCCA180		VCCD180	
R	LVD_IBG		VSS		VCCP		VCC
P		VSS		VSS		VCCP33	
N	IOCOMP0[0]		VSS		VCCQ		VCCD
M		VSS		VSS		VCCD	
L	VSS		VSS		VCCP		VCCD
K		VSS		VSS		VSS	
J	VSS		VSS		VSS		VCCA_PEG
H		VSS		VSS		VCCA_PEG	
G	VSS		VSS		VSS		VSS
F		VSS		VSS		VSS	
E	PCIE_PERN[1]		PCIE_PETN[1]		PCIE_PETN[0]		NC
D		PCIE_PERP[1]		PCIE_PETP[1]		PCIE_PETP[0]	
C	VSS		VSS		VSS		VSS
B		NC		PCIE_CLKINP		PCIE_ICOMPO	
A	PCIE_PERP[0]		NC		PCIE_CLKINN		PCIE_RCOMPO

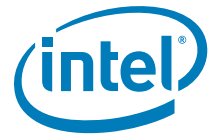

Figure 17. Intel® Atom™ Processor E6xx Series Ball Map (Sheet 5 of 5)

	37	36	35	34	33	32	31
AU			VSS	VSS		VID[0]	
AT			VSS		VID[5]		VID[6]
AR		VSS		VID[4]		VSS	
AP	VSS		BPM_B[1]		BPM_B[0]		NC
AN		BPM_B[3]		BPM_B[2]		VSS	
AM	PREQ_B		VSS		PRDY_B		BSEL[0]
AL		NC		COMP0[1]		VSS	
AK	NC		NC		NC		NC
AJ		NC		NC		VSS	
AH	GTLREF		VSS		NC		NC
AG		CMREF		NC		VSS	
AF	NC		NC		NC		NC
AE		NC		NC		VSS	
AD	NC		VSS		NC		NC
AC		NC		DLIOCMREF		VSS	
AB	DLIOGTLREF		COMP1[0]		COMP1[1]		NC
AA		NC		NC		VSS	
Y	NC		VSS		NC		NC
W		NC		NC		VSS	
V	NC		NC		LVD_DATAP_0		LVD_DATAN_1
U		LVD_CLKP		LVD_DATAN_0		VSS	
T	LVD_CLKN		VSS		LVD_DATAP_3		LVD_VBG
R		LVD_DATAN_2		LVD_DATAN_3		VSS	
P	LVD_DATAP_2		VSS		THRMDA		HDA_RST_B
N		LVD_VREFL		THRMDC		HDA_SDI[0]	
M	LVD_VREFH		VSS		VSS		VSS
L		NC		IOCOMP0[1]		VSS	
K	NC		VSS		IOGTLREF		VSS
J		HDA_SDO		IOCMREF		VSS	
H	RCOMP		VSS		VSS		PCIE_PETP[3]
G		HDA_SDI[1]		VSS		PCIE_PETN[3]	
F	HDA_DOCKEN_B		HDA_SYNC		VSS		VSS
E		HDA_CLK		NC		PCIE_PETN[2]	
D	VSS		HDA_DOCKRST_B		PCIE_PERP[3]		PCIE_PETP[2]
C		VSS		PCIE_PERN[3]		VSS	
B			VSS		PCIE_PERN[2]		PCIE_PERN[0]
A			VSS		VSS	PCIE_PERP[2]	



Table 407. Pin List

Pin Name	Ball#
BCLKP	AT25
BCLKN	AU26
BPM_B[0]	AP33
BPM_B[1]	AP35
BPM_B[2]	AN34
BPM_B[3]	AN36
BSEL[0]	AM31
BSEL[1]	AP21
BSEL[2]	AP25
CLK14	J8
CMREF	AG36
COMP0[0]	AJ30
COMP0[1]	AL34
COMP1[0]	AB35
COMP1[1]	AB33
DLIOCMREF	AC34
DLIOGTLREF	AB37
GPE_B	N2
GPIO[0]	E6
GPIO[1]	C4
GPIO[2]	A6
GPIO[3]	D5
GPIO[4]	B5
GPIO_SUS[0]	L10
GPIO_SUS[1]	N4
GPIO_SUS[2]	P1
GPIO_SUS[3]	M3
GPIO_SUS[4]	K11
GPIO_SUS[5]	M1
GPIO_SUS[6]	L2
GPIO_SUS[7]	J4
GPIO_SUS[8]	H1
GPIO_B	AP19
GTLREF	AL30
GTLVREF	AP23
HDA_CLK	E36
HDA_DOCKEN_B	F37
HDA_DOCKRST_B	D35
HDA_RST_B	P31
HDA_SDI[0]	N32
HDA_SDI[1]	G36
HDA_SDO	J36
HDA_SYNC	F35

Table 407. Pin List

Pin Name	Ball#
HIGHZ_B	W2
HPLL_REFCLK_N	W4
HPLL_REFCLK_P	V5
IO_RX_CVREF	U4
IO_RX_GVREF	U2
IO_TCK	T1
IO_TDI	AC2
IO_TDO	AD1
IO_TMS	AB1
IO_TRST_B	R2
IOCMREF	J34
IOCOMP0[0]	N30
IOCOMP0[1]	L34
IOCOMP1[0]	T5
IOCOMP1[1]	R6
IOGTLREF	K33
LPC_AD[0]	D13
LPC_AD[1]	D3
LPC_AD[2]	G8
LPC_AD[3]	G12
LPC_CLKOUT[0]	E12
LPC_CLKOUT[1]	D9
LPC_CLKOUT[2]	E10
LPC_CLKRUN_B	D7
LPC_FRAME_B	D11
LPC_SERIRQ	E8
LVD_CLKN	T37
LVD_CLKP	U36
LVD_DATAN_0	U34
LVD_DATAN_1	V31
LVD_DATAN_2	R36
LVD_DATAN_3	R34
LVD_DATAP_0	V33
LVD_DATAP_1	U30
LVD_DATAP_2	P37
LVD_DATAP_3	T33
LVD_IBG	R30
LVD_VBG	T31
LVD_VREFH	M37
LVD_VREFL	N36
M_BS[0]	AB5
M_BS[1]	AM1
M_BS[2]	AL2
M_CASB	AP17
M_CKP	AU8

Table 407. Pin List

Pin Name	Ball#
M_CKN	AT7
M_CKE[0]	AK7
M_CKE[1]	AM7
M_CSB[0]	AN14
M_CSB[1]	AJ12
M_DM[0]	AG2
M_DM[1]	AF5
M_DM[2]	AU20
M_DM[3]	AP13
M_DQ[0]	AK1
M_DQ[1]	AF1
M_DQ[10]	AR4
M_DQ[11]	AJ4
M_DQ[12]	AK5
M_DQ[13]	AP5
M_DQ[14]	AM5
M_DQ[15]	AH5
M_DQ[16]	AU16
M_DQ[17]	AU18
M_DQ[18]	AT17
M_DQ[19]	AT21
M_DQ[2]	AJ2
M_DQ[20]	AU22
M_DQ[21]	AT23
M_DQ[22]	AT19
M_DQ[23]	AU24
M_DQ[24]	AN8
M_DQ[25]	AP9
M_DQ[26]	AU12
M_DQ[27]	AT11
M_DQ[28]	AP11
M_DQ[29]	AN10
M_DQ[3]	AH1
M_DQ[30]	AL10
M_DQ[31]	AT15
M_DQ[4]	AG4
M_DQ[5]	AE4
M_DQ[6]	AA4
M_DQ[7]	AC4
M_DQ[8]	AU6
M_DQ[9]	AL4
M_DQS[0]	Y5
M_DQS[1]	AT5
M_DQS[2]	AP15
M_DQS[3]	AU14

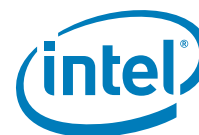

Table 407. Pin List

Pin Name	Ball#
M_MA[0]	AA8
M_MA[1]	AA10
M_MA[10]	W10
M_MA[11]	AG8
M_MA[12]	AD5
M_MA[13]	AU10
M_MA[14]	AJ8
M_MA[2]	AN4
M_MA[3]	Y7
M_MA[4]	AN2
M_MA[5]	AP7
M_MA[6]	AH7
M_MA[7]	W8
M_MA[8]	AB7
M_MA[9]	AF7
M_ODT[0]	AK11
M_ODT[1]	AN12
M_RASB	AJ10
M_RCOMPOUT	AE8
M_RCVENIN	AC8
M_RCVENOUT	AD7
M_SRFWEN	AT9
M_WEB	AT13
NCTCK	AN28
NCTDI	AL22
NCTDO	AU30
NCTMS	AP27
PCIE_CLKINN	A26
PCIE_CLKINP	B27
PCIE_ICOMPI	B23
PCIE_ICOMPO	B25
PCIE_PERN[0]	B31
PCIE_PERN[1]	E30
PCIE_PERN[2]	B33
PCIE_PERN[3]	C34
PCIE_PERP[0]	A30
PCIE_PERP[1]	D29
PCIE_PERP[2]	A32
PCIE_PERP[3]	D33
PCIE_PETN[0]	E26
PCIE_PETN[1]	E28
PCIE_PETN[2]	E32
PCIE_PETN[3]	G32
PCIE_PETP[0]	D25

Table 407. Pin List

Pin Name	Ball#
PCIE_PETP[1]	D27
PCIE_PETP[2]	D31
PCIE_PETP[3]	H31
PCIE_RBIAS	E22
PCIE_RCOMPO	A24
PRDY_B	AM33
PREQ_B	AM37
PROCHOT_B	AT27
PWRMODE[0]	AK23
PWRMODE[1]	AN26
PWRMODE[2]	AL24
PWROK	Y1
RCOMP	H37
RESET_B	K5
RSMRST_B	V1
RSTRDY_B	K7
RSTWARN	L4
RTRCRST_B	AA2
RTCX1	L8
RTCX2	M7
SDVO_BLUEN	D17
SDVO_BLUEP	E18
SDVO_CLKN	A12
SDVO_CLKP	B13
SDVO_CTRLCLK	E14
SDVO_CTRLDATA	B7
SDVO_GREENN	B19
SDVO_GREENP	A18
SDVO_INTN	A20
SDVO_INTP	B21
SDVO_REDN	A16
SDVO_REDP	B17
SDVO_REFCLKN	A10
SDVO_REFCLKP	B11
SDVO_STALLN	D19
SDVO_STALLP	E20
SDVO_TVCLKINN	A14
SDVO_TVCLKINP	B15
SLPMODE	M5
SLPRDY_B	K1
SMB_ALERT_B	F7
SMB_CLK	E4
SMB_DATA	G14
SMBI_B	H7

Table 407. Pin List

Pin Name	Ball#
SPI_CS_B	H5
SPI_MISO	E2
SPI_MOSI	F1
SPI_SCK	F5
SPKR	G2
SUSCLK	J2
TCK	AN22
TDI	AN16
TDO	AN18
TEST_B	H3
THERMTRIP_B	AU28
THRM_B	G10
THRMADA	P33
THRMDC	N34
TMS	AL16
TRST_B	AL14
VCC	R22
VCC	R24
VCC	U22
VCC	U24
VCC	W22
VCC	W24
VCC	AA22
VCC	AA24
VCC	AC22
VCC	AC24
VCC	AE22
VCC	AE24
VCC	AG22
VCC	AG24
VCC180	P17
VCC180	R16
VCC180	T13
VCC180	T15
VCC180	U14
VCC180	U16
VCC180	W16
VCC180	Y15
VCC180	AA16
VCC180	AD15
VCC180	AG12
VCC180	AH9
VCC180	AH11
VCC180	AH13

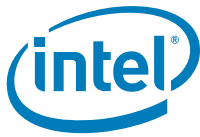

Table 407. Pin List

Pin Name	Ball#
VCC180	AH15
VCC180	AJ14
VCC180	AK13
VCC180SR	AB13
VCC33RTC	M13
VCCA	AB25
VCCA	AC14
VCCA	AJ20
VCCA_PEG	H25
VCCA_PEG	J18
VCCA_PEG	J20
VCCA_PEG	J22
VCCA_PEG	J24
VCCA_PEG	K21
VCCA_PEG	K23
VCCA180	T27
VCCD	L18
VCCD	L20
VCCD	L22
VCCD	L24
VCCD	M25
VCCD	N22
VCCD	N24
VCCD_DPL	K19
VCCD180	T25
VCCDSENSE	N20
VCCDSUS	K15
VCCF	AM25
VCCFHV	P19
VCCP	L26
VCCP	P15
VCCP	R26
VCCP	W26
VCCP	AC26
VCCP	AG26
VCCP	AJ26
VCCP	AK15
VCCP33	J16
VCCP33	K17
VCCP33	P25
VCCP33SUS	K13
VCCPA	U26
VCCPA	AK25
VCCPDDR	V13

Table 407. Pin List

Pin Name	Ball#
VCCPDDR	W12
VCCPDDR	AC12
VCCPDDR	AE12
VCCPDDR	AF13
VCCPQ	AJ16
VCCPSUS	N12
VCCQ	N26
VCCQ	P11
VCCQ	AF27
VCCQHPLL	N18
VCCRTCEXT	L12
VCCSENSE	AJ22
VCCSFR_EXP	H19
VCCSFRDPLL	H17
VCCSFRHPLL	M15
VID[0]	AU32
VID[1]	AT29
VID[2]	AL28
VID[3]	AP29
VID[4]	AR34
VID[5]	AT33
VID[6]	AT31
VIDEN[0]	AK27
VIDEN[1]	AL26
VMM	T23
VNN	R18
VNN	R20
VNN	U18
VNN	U20
VNN	W18
VNN	W20
VNN	AA18
VNN	AA20
VNN	AC18
VNN	AC20
VNN	AE18
VNN	AE20
VNN	AG18
VNN	AJ18
VNNSENSE	AG20
VSS	A4
VSS	A34
VSS	B3
VSS	B35

Table 407. Pin List

Pin Name	Ball#
VSS	C2
VSS	C6
VSS	C8
VSS	C10
VSS	C12
VSS	C14
VSS	C16
VSS	C18
VSS	C20
VSS	C22
VSS	C24
VSS	C26
VSS	C28
VSS	C30
VSS	C32
VSS	C36
VSS	D1
VSS	D37
VSS	F3
VSS	F9
VSS	F11
VSS	F13
VSS	F15
VSS	F17
VSS	F19
VSS	F21
VSS	F23
VSS	F25
VSS	F27
VSS	F29
VSS	F31
VSS	F33
VSS	G6
VSS	G16
VSS	G18
VSS	G20
VSS	G22
VSS	G24
VSS	G26
VSS	G28
VSS	G30
VSS	G34
VSS	H9
VSS	H13

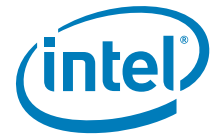

Table 407. Pin List

Pin Name	Ball#
VSS	H15
VSS	H21
VSS	H23
VSS	H27
VSS	H29
VSS	H33
VSS	H35
VSS	J6
VSS	J10
VSS	J12
VSS	J14
VSS	J26
VSS	J28
VSS	J30
VSS	J32
VSS	K3
VSS	K9
VSS	K25
VSS	K27
VSS	K29
VSS	K31
VSS	K35
VSS	L6
VSS	L14
VSS	L16
VSS	L28
VSS	L30
VSS	L32
VSS	M9
VSS	M11
VSS	M17
VSS	M21
VSS	M23
VSS	M27
VSS	M29
VSS	M31
VSS	M33
VSS	M35
VSS	N6
VSS	N8
VSS	N10
VSS	N14
VSS	N16
VSS	N28

Table 407. Pin List

Pin Name	Ball#
VSS	P3
VSS	P5
VSS	P7
VSS	P9
VSS	P13
VSS	P21
VSS	P23
VSS	P27
VSS	P29
VSS	P35
VSS	R8
VSS	R10
VSS	R12
VSS	R14
VSS	R28
VSS	R32
VSS	T3
VSS	T7
VSS	T9
VSS	T11
VSS	T17
VSS	T19
VSS	T21
VSS	T29
VSS	T35
VSS	U6
VSS	U8
VSS	U10
VSS	U12
VSS	U28
VSS	U32
VSS	V3
VSS	V7
VSS	V9
VSS	V11
VSS	V15
VSS	V17
VSS	V19
VSS	V21
VSS	V23
VSS	V25
VSS	V27
VSS	V29
VSS	W6
VSS	W14

Table 407. Pin List

Pin Name	Ball#
VSS	W28
VSS	W32
VSS	Y3
VSS	Y9
VSS	Y11
VSS	Y13
VSS	Y17
VSS	Y19
VSS	Y21
VSS	Y23
VSS	Y25
VSS	Y27
VSS	Y29
VSS	Y35
VSS	AA6
VSS	AA12
VSS	AA14
VSS	AA26
VSS	AA28
VSS	AA32
VSS	AB3
VSS	AB9
VSS	AB11
VSS	AB15
VSS	AB17
VSS	AB19
VSS	AB21
VSS	AB23
VSS	AB27
VSS	AB29
VSS	AC6
VSS	AC10
VSS	AC16
VSS	AC28
VSS	AC32
VSS	AD3
VSS	AD9
VSS	AD11
VSS	AD13
VSS	AD17
VSS	AD19
VSS	AD21
VSS	AD23
VSS	AD25
VSS	AD27

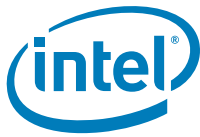

Table 407. Pin List

Pin Name	Ball#
VSS	AD29
VSS	AD35
VSS	AE2
VSS	AE6
VSS	AE10
VSS	AE14
VSS	AE16
VSS	AE26
VSS	AE28
VSS	AE32
VSS	AF3
VSS	AF9
VSS	AF11
VSS	AF15
VSS	AF17
VSS	AF19
VSS	AF21
VSS	AF23
VSS	AF25
VSS	AF29
VSS	AG6
VSS	AG10
VSS	AG14
VSS	AG16
VSS	AG28
VSS	AG32
VSS	AH3
VSS	AH17
VSS	AH19
VSS	AH23
VSS	AH25
VSS	AH27
VSS	AH29
VSS	AH35
VSS	AJ6
VSS	AJ24
VSS	AJ28
VSS	AJ32
VSS	AK3
VSS	AK9
VSS	AK29
VSS	AL6
VSS	AL12
VSS	AL32
VSS	AM3
VSS	AM9
VSS	AM11
VSS	AM13
VSS	AM15

Table 407. Pin List

Pin Name	Ball#
VSS	AM17
VSS	AM19
VSS	AM21
VSS	AM23
VSS	AM27
VSS	AM29
VSS	AM35
VSS	AN6
VSS	AN20
VSS	AN32
VSS	AP1
VSS	AP3
VSS	AP37
VSS	AR2
VSS	AR6
VSS	AR8
VSS	AR10
VSS	AR12
VSS	AR14
VSS	AR16
VSS	AR18
VSS	AR20
VSS	AR22
VSS	AR24
VSS	AR26
VSS	AR28
VSS	AR30
VSS	AR32
VSS	AR36
VSS	AT3
VSS	AT35
VSS	AU4
VSS	AU34
VCCD_VSSSENSE	M19
VCC_VSSSENSE	AH21
WAKE_B	H11
NC	A8
NC	A22
NC	A28
NC	B9
NC	B29
NC	D15
NC	D21
NC	D23
NC	E16
NC	E24

Table 407. Pin List

Pin Name	Ball#
NC	E34
NC	G4
NC	K37
NC	L36
NC	R4
NC	V35
NC	V37
NC	W30
NC	W34
NC	W36
NC	Y31
NC	Y33
NC	Y37
NC	AA30
NC	AA34
NC	AA36
NC	AB31
NC	AC30
NC	AC36
NC	AD31
NC	AD33
NC	AD37
NC	AE30
NC	AE34
NC	AE36
NC	AF31
NC	AF33
NC	AF35
NC	AF37
NC	AG30
NC	AG34
NC	AH31
NC	AH33
NC	AJ34
NC	AJ36
NC	AK17
NC	AK19
NC	AK21
NC	AK31
NC	AK33
NC	AK35
NC	AK37
NC	AL8
NC	AL18
NC	AL20
NC	AL36
NC	AN24
NC	AN30
NC	AP31

§ §



Compare Queue (0)

Send Feedback

English

Type Here to Search Products

Home Intel® Processors Intel® Atom™ Processor Intel® Atom™ Processor E600 Series E660T



Intel® Atom™ Processor E660T (512K Cache, 1.30 GHz)

SPECIFICATIONS

- All
- Essentials
- Memory Specifications
- Graphics Specifications
- Expansion Options
- Package Specifications
- Advanced Technologies

COMPATIBLE PRODUCTS

ORDERING / SSPECS / STEPPINGS

Specifications

Essentials

Status	Launched
Launch Date	Q3'10
Processor Number	E660T
# of Cores	1
# of Threads	2
Clock Speed	1.3 GHz
L2 Cache	512 KB
Bus/Core Ratio	13
PCI Express*	2500 MHz
FSB Parity	No
Instruction Set	32-bit
Embedded Options Available	Yes
Lithography	45 nm
Max TDP	3.6 W
VID Voltage Range	VCC (0.75 - 0.9V), VNN (0.75 - 1.1V)
Recommended Customer Price	\$64

Memory Specifications

Max Memory Size (dependent on memory type)	2 GB
Memory Types	DDR2-800
# of Memory Channels	1
ECC Memory Supported	No

Graphics Specifications

Integrated Graphics	Yes
Graphics Base Frequency	400 MHz

Expansion Options

PCI Express Revision	1.0a
PCI Express Configurations	x1, root complex only

COMPARE PRODUCTS

- [Add to Compare](#)
- [Compare Now \(0\)](#)

- [Find Embedded](#)
- [Visit the Embedded Center >](#)

QUICK LINKS

- [Products from Intel Creek](#)
- [Download Data](#)

ADDITIONAL INFO

SUPPORT AND DOWNLOADS







- [Software Download](#)
- [Support Overview >](#)

SEARCH DISTRIBUTORS

PCN/MDDS INFORMATION

[Visit Intel AppUp <s >](#)

Intel® Atom™ Processor E660T (512K Cache, 1.30 GHz)

# of PCI Express Ports	4
Package Specifications	
T _{JUNCTION}	110°C
Package Size	22mmx22mm
Sockets Supported	FCBGA676
Low Halogen Options Available	See MDDS
Advanced Technologies	
Intel® Turbo Boost Technology	No
Intel® Hyper-Threading Technology	 Yes
Intel® Virtualization Technology (VT-x)	 Yes
Intel® Virtualization Technology for Directed I/O (VT-d)	 No
Intel® Trusted Execution Technology	 No
Intel® 64	 No
Idle States	Yes
Enhanced Intel SpeedStep® Technology	 Yes
Intel® Demand Based Switching	No
Thermal Monitoring Technologies	Yes
Execute Disable Bit	Yes

"Announced" SKUs are not yet available. Please refer to the Launch Date for market availability.

The Recommended Customer Price ("RCP") is pricing guidance for Intel products. Prices are for direct Intel customers and are subject to change without notice. Taxes and shipping, and other charges may apply. Prices may vary for other package types and shipment quantities, and special promotional arrangements may apply. Listing of these RCP does not constitute a formal pricing offer for work with your appropriate Intel representative to obtain a formal price quotation.

Enabling Execute Disable Bit functionality requires a PC with a processor with Execute Disable Bit capability and a supporting operating system. Check with your PC manufacturer on system delivers Execute Disable Bit functionality.

64-bit computing on Intel® architecture requires a computer system with a processor, chipset, BIOS, operating system, device drivers and applications enabled for Intel® 64 architecture will not operate (including 32-bit operation) without an Intel 64 architecture-enabled BIOS. Performance will vary depending on your hardware and software configurations. Consult your vendor for more information.

Hyper-Threading Technology (HT Technology) requires a computer system with an Intel® processor supporting HT Technology and an HT Technology enabled chipset, BIOS and operating system. Performance will vary depending on the specific hardware and software you use. See www.intel.com/products/ht/hyperthreading_more.htm for more information including details on processors support HT Technology.

Intel® Virtualization Technology requires a computer system with a processor, chipset, BIOS, virtual machine monitor (VMM) and for some uses, certain platform software, enabled for performance or other benefit will vary depending on hardware and software configurations. Intel Virtualization Technology-enabled VMM applications are currently in development.

Intel processor numbers are not a measure of performance. Processor numbers differentiate features within each processor family, not across different processor families. See http://www.intel.com/products/processor_number for details.

System and Maximum TDP is based on worst case scenarios. Actual TDP may be lower if not all I/Os for chipsets are used.

All information provided is subject to change at any time, without notice. Intel may make changes to manufacturing life cycle, specifications, and product descriptions at any time, with information herein is provided "as-is" and Intel does not make any representations or warranties whatsoever regarding accuracy of the information, nor on the product features, availability, functionality, or compatibility of the products listed. Please contact system vendor for more information on specific products or systems.

Low Halogen: Applies only to brominated and chlorinated flame retardants (BFRs/CFRs) and PVC in the final product. Intel components as well as purchased components on the finish JS-709 requirements, and the PCB / substrate meet IEC 61249-2-21 requirements. The replacement of halogenated flame retardants and/or PVC may not be better for the environment.

Max Turbo Frequency refers to the maximum single-core frequency that can be achieved with Intel® Turbo Boost Technology, which requires a PC with a processor with Intel Turbo Boost capability. Intel Turbo Boost Technology performance varies depending on hardware, software, and overall system configuration. Check with your PC manufacturer on whether you support Intel Turbo Boost Technology. See www.intel.com/technology/turboboost/ for more information.

Some products can support AES New Instructions with a Processor Configuration update, in particular, i7-2630QM/i7-2635QM, i7-2670QM/i7-2675QM, i5-2430M/i5-2435M, i5-2410M