

WIRE WOUND CHIP INDUCTORS SWI1008FT SERIES

Introductions

The SWI series are wire wound chip inductors widely used in the communication applications such as cellular phones, cable modem, ADSL, repeaters, Bluetooth, and other electronic devices.

The wire wound inductors advance in higher self resonate frequency, better Q factor, and much more stable performance. Precious tolerance of 2% is available.

Features

- * Operating temperature -40 to +85°C.
- * Excellent solderability and resistance to soldering heat.
- * Suitable for reflow soldering.
- * High reliability and easy surface mount assembly.
- * Wide range of inductance values are available for flexible needs.

Part Number Code

SWI 1008 F T 3R3 J - □□

1 2 3 4 5 6

1 Product Type

2 Chip Dimension

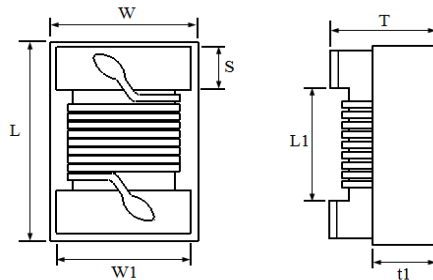

Size (inch) mm	Length (L) (inch) mm	Width (W) (inch) mm	Thickness (T) (inch) mm	Terminal (S) (inch) mm	L1 (Ref.) mm	W1 (Ref.) mm	(t1) (Ref.) mm
SWI 1008	(0.102 ± 0.008)	(0.083 ± 0.008)	(0.067 ± 0.008)	(0.020 ± 0.004)	1.40	1.60~1.90	0.70
2520	2.60 ± 0.20	2.10 ± 0.20	1.70 ± 0.20	0.50 ± 0.10			

3 Material Type F : Ferrite Material

4 Inductance Value 3R3 = 3.3μH 330 = 33μH

5 Tolerance J = ±5% K = ±10%

6 Internal Code If any

CHIP INDUCTOR SPECIFICATIONS

1. Scope

This specification applies to fixed inductors of the following types used in electronic equipment.

Ferrite Type : For higher inductance at lower frequency circuit requirement.

2. Construction

Configuration

& Dimension : Please refer to the attached figures and tables.

Terminals : The terminals shall consist of Ag alloy followed by Nickel, then Tin plating for easier soldering.

3. Operating Temperature Range

Operating Temperature Range is the scope of ambient temperature at which the inductor can be operated continuously at rated current.

Temp. Range : -40°C to +85°C

4. Ingredient of terminals electrode

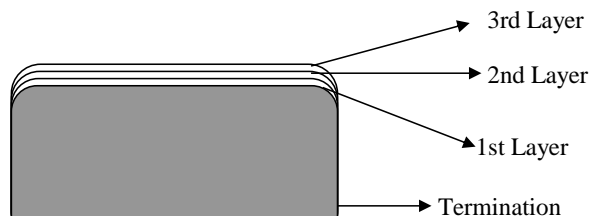

- a) 1st layer : Ag
- b) 2nd layer : Ni
- c) 3rd layer : Sn

5. Characteristics

Standard Atmospheric Conditions

Unless otherwise specified, the standard range of atmospheric conditions for making measurements and tests are as follows :

Ambient Temperature : 25°C ± 2°C

Relative Humidity : 60% to 70%

Air Pressure : 86 kPa to 106 kPa

CHIP INDUCTOR SPECIFICATIONS

Temperature profile

- a. Reflow temperature profile
(Temperature of the mounted parts surface on the printed circuit board)

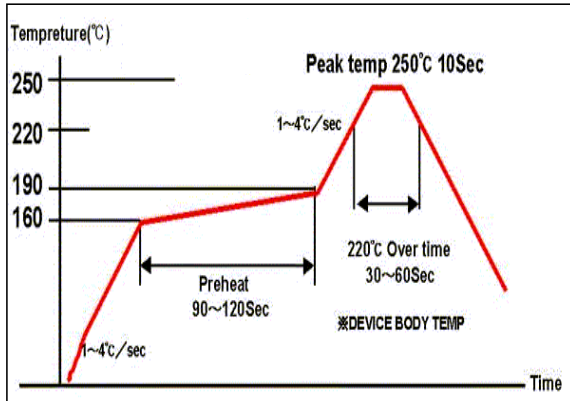

Recommended Peak Temperature : 250°C Max
250°C up /within 10secs
Max. Reflow temperature : 260°C.
Gradient of temperature rise : av 1-4°C/sec
Preheat : 160-190°C/within 90-120secs
220°C up /within 30-60secs
Composition of solder Sn-3Ag-0.5Cu

- b. Dip temperature

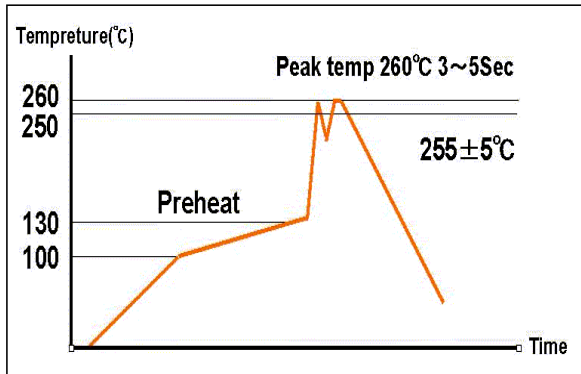

Solder bathtub temperature: 260°C max.
within 5secs.
Preheating temperature: 100~130°C
deposit solder temperature.
Composition of solder Sn-3Ag-0.5Cu

- c. Soldering iron tip temperature : 350°C max / within 3 seconds.

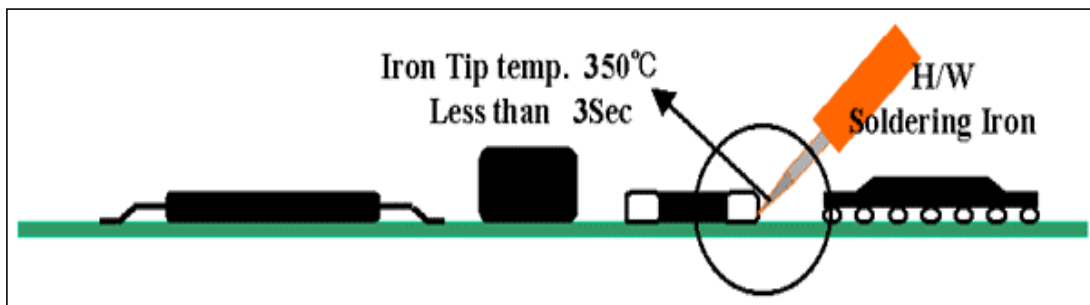

**CHIP INDUCTOR
WIRE WOUND TYPE**

SWI1008 (2520) FERRITE SERIES

Specification

Part No.	Inductance ¹ (μ H)	Percent Tolerance	Q ² Min	S.R.F. ³ Min (MHz)	RDC ⁴ Max (Ω)	IDC ⁵ Max (mA)	Marking
SWI1008FTR47 □-□□	0.47 @ 25MHz	K, J	45 @ 100MHz	480	0.55	500	R47
SWI1008FTR56 □-□□	0.56 @ 25MHz	K, J	45 @ 100MHz	430	0.60	500	R56
SWI1008FTR68 □-□□	0.68 @ 25MHz	K, J	45 @ 100MHz	380	0.80	500	R68
SWI1008FTR82 □-□□	0.82 @ 25MHz	K, J	45 @ 100MHz	350	0.92	500	R82
SWI1008FT1R0 □-□□	1.0 @ 25MHz	K, J	35 @ 50MHz	310	1.75	430	1R0
SWI1008FT1R2 □-□□	1.2 @ 7.96MHz	K, J	20 @ 7.96MHz	280	1.30	230	1R2
SWI1008FT1R5 □-□□	1.5 @ 7.96MHz	K, J	20 @ 7.96MHz	250	1.65	220	1R5
SWI1008FT1R8 □-□□	1.8 @ 7.96MHz	K, J	20 @ 7.96MHz	200	2.20	210	1R8
SWI1008FT2R2 □-□□	2.2 @ 7.96MHz	K, J	20 @ 7.96MHz	160	2.35	200	2R2
SWI1008FT2R7 □-□□	2.7 @ 7.96MHz	K, J	20 @ 7.96MHz	130	2.60	195	2R7
SWI1008FT3R3 □-□□	3.3 @ 7.96MHz	K, J	20 @ 7.96MHz	80	2.85	185	3R3
SWI1008FT3R9 □-□□	3.9 @ 7.96MHz	K, J	20 @ 7.96MHz	50	4.00	180	3R9
SWI1008FT4R7 □-□□	4.7 @ 7.96MHz	K, J	20 @ 7.96MHz	45	4.30	175	4R7
SWI1008FT5R6 □-□□	5.6 @ 7.96MHz	K, J	20 @ 7.96MHz	42	2.60	170	5R6
SWI1008FT6R8 □-□□	6.8 @ 7.96MHz	K, J	20 @ 7.96MHz	39	2.80	165	6R8
SWI1008FT8R2 □-□□	8.2 @ 7.96MHz	K, J	20 @ 7.96MHz	36	3.05	160	8R2
SWI1008FT100 □-□□	10 @ 2.52MHz	K, J	15 @ 2.52MHz	33	3.50	150	100
SWI1008FT120 □-□□	12 @ 2.52MHz	K, J	15 @ 2.52MHz	30	3.60	140	120
SWI1008FT150 □-□□	15 @ 2.52MHz	K, J	15 @ 2.52MHz	26	4.00	130	150
SWI1008FT180 □-□□	18 @ 2.52MHz	K, J	15 @ 2.52MHz	24	4.50	120	180
SWI1008FT220 □-□□	22 @ 2.52MHz	K, J	15 @ 2.52MHz	22	5.00	110	220
SWI1008FT270 □-□□	27 @ 2.52MHz	K, J	15 @ 2.52MHz	21	6.00	95	270
SWI1008FT330 □-□□	33 @ 2.52MHz	K, J	15 @ 2.52MHz	20	6.50	85	330
SWI1008FT390 □-□□	39 @ 2.52MHz	K, J	15 @ 2.52MHz	18	8.50	60	390
SWI1008FT470 □-□□	47 @ 2.52MHz	K, J	15 @ 2.52MHz	17	14.00	45	470

1. Inductance is measured in HP-4287A RF LCR meter with HP-16193 test fixture

2. Inductance is measured in HP-4287A RF LCR meter with HP-16193 test fixture

3. SRF is measured in ENA E5071B network analyzer or equivalent.

4. RDC is measured in HP-4338B milliohm meter or equivalent.

5. For 15 °C Rise.

Unit weight = 0.025g (for ref.)

CHIP INDUCTOR
WIRE WOUND TYPE

SWI1008 (2520) FERRITE SERIES

Specification

L vs Freq Plot

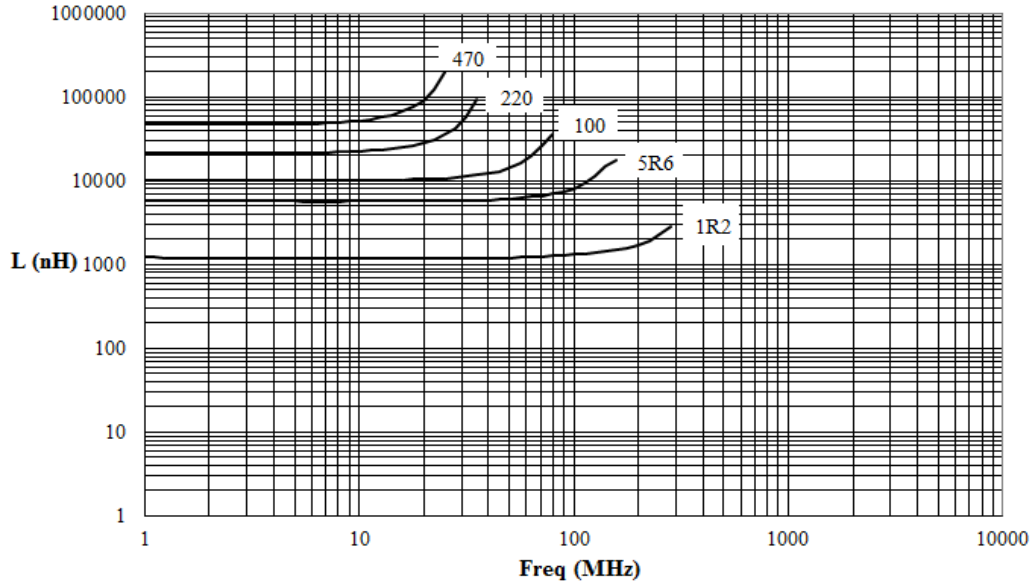

Q vs Freq Plot

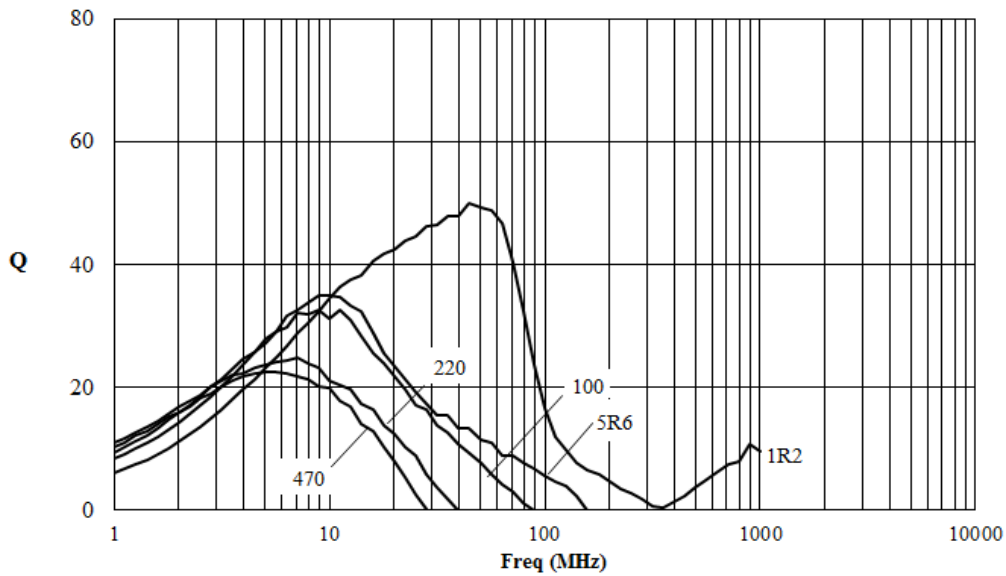

RELIABILITY TEST

ITEM		CONDITION	SPECIFICATION
Electrical Characteristics	Inductance and Tolerance	Measuring Frequency : As shown in Product Table Measuring Temperature : + 25 °C	Within Specified Tolerance
	Quality Factor		
	Insulation Resistance	Measured at 100V DC between inductor terminals and center of case.	1000 mega ohms minimum
	Dielectric Withstanding Voltage	Measured at 500V AC between inductor terminals and center of case for a maximum of 1 minute.	No damage occurs when the test voltage is applied.
	Temperature Coefficient of Inductance (TCL)	Over -40°C to +85°C at frequency specified in Product Table.	+ 25 to 500 ppm / °C $TCL = \frac{L1 - L2}{L1(T1-T2)} \times 10^6$ (ppm / °C)
Mechanical Characteristics	Component Adhesion (Push Test)	The component shall be reflow soldered onto a P. C. Board (240°C ± 5°C for 20 seconds). Then a dynamometer force gauge shall be applied to any side of the component.	1008 series ≥ 1.0kg
	Drop Test	The inductor shall be dropped two times on the concrete floor or the vinyl tile from 1m naturally.	Change In Inductance: No more than 5% Change In Q: No more than 10%
	Thermal Shock Test	Each cycle shall consist of 30 minutes at -40°C followed by 30 minutes at +85°C with 5 minutes maximum transition time between temperature extremes. Test duration is 10 cycles.	Change In Appearance: Without distinct damage

RELIABILITY TEST

ITEM		CONDITION	SPECIFICATION
Endurance Characteristics	Solderability	Dip pads in flux and dip in solder pot containing lead free solder at $240\pm 5^{\circ}\text{C}$ for 5 seconds.	A minimum of 80% of the metalized area must be covered with solder.
	Resistance to Soldering Heat	Dip the components into flux and dip into solder pot containing lead free solder at $260\pm 5^{\circ}\text{C}$ for 5 ± 2 seconds.	Change In Inductance: No more than 5%
	Vibration (Random)	Inductors shall be randomly vibrated at amplitude of 1.5mm and frequency of 10 - 55 Hz: 0.04 G / Hz for a minimum of 15 minutes per axis for each of the three axes.	Change In Q: No more than 10%
	Cold Temperature Storage	Inductors shall be stored at temperature of $-40^{\circ}\text{C} \pm 2^{\circ}\text{C}$ for 1000 hours (+48 -0h). Then inductors shall be subjected to standard atmospheric conditions for 1 hour. After that, measurement shall be made.	Change In Appearance : Without distinct damage
	High Temperature Storage	Inductors shall be stored at temperature of $85^{\circ}\text{C} \pm 2^{\circ}\text{C}$ for 1000 hours (+48 -0h). Then inductors shall be subjected to standard atmospheric conditions for 1 hour. After that, measurement shall be made.	
	Moisture Resistance	Inductors shall be stored in the chamber at 45°C at 90-95 R.H. for 1000 hours. Then inductors are to be tested after 2 hours at room temperature.	Inductors shall not have a shorted or open winding.
	High Temperature with Loaded	Inductors shall be stored in the chamber at 85°C for 1000 hours with rated current applied. Inductors shall be tested at the beginning of the test at 500 hours and 1000 hours. Then inductors are to be tested after 1 hour at room temperature.	

PACKING INFORMATION

Packing Quantity

Type	Pcs / Reel
SWI1008	2,000

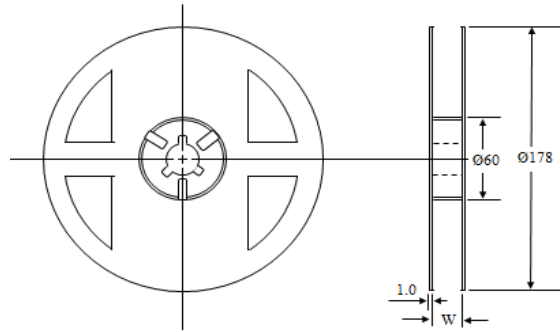

Dimensions (unit : mm)

Type	Chip Cavity		Insert Pitch	Tape Thickness		W
	A	B	F	K	T	
SWI1008	2.20	2.83	4.00	1.75	0.22	8.00

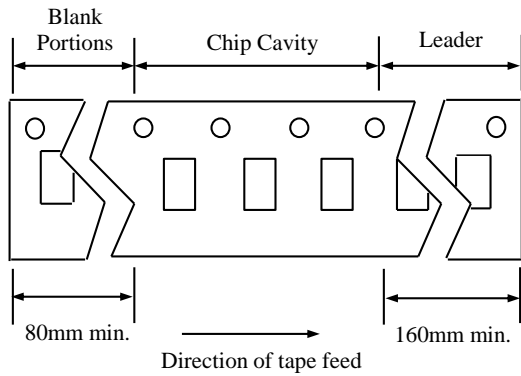
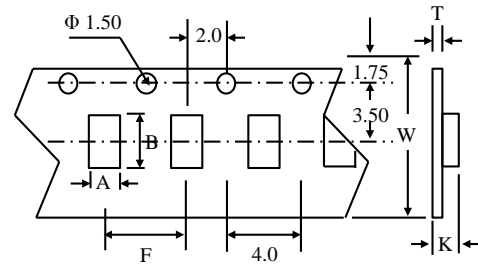

Top Tape Strength

The top tape requires a peel-off force of 0.2 to 0.7N in the direction of the arrow as illustrated below.

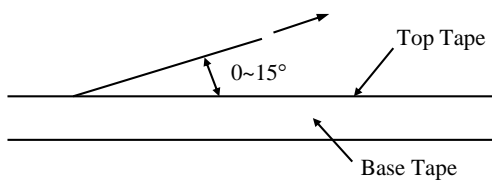

Recommended Pattern

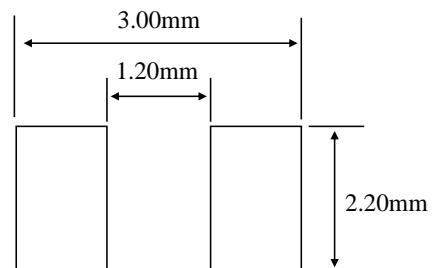

SAFETY NOTES & PRECAUTION

1. Products may not be used in applications that directly affect the personal safety or cause significant impacts and losses to society. If you apply to these applications, please be sure to contact us at first to confirm.

2. The storage period is less than 12 months. Ensure to follow the storage conditions (Temperature: 5 to 30°C, Humidity: 10 to 60% RH or less). If the storage period is exceeded the limit, the electrodes might be deteriorate/oxidized and affect soldering. Solderability should be checked if this period is exceeded.

Other storage precaution:

- a) Products should be stored on the pallet for the prevention of the influence from humidity, dust and so on.
- b) Products should be stored in the warehouse without heat shock, vibration, direct sunlight and so on.
- c) Do not unpack the minimum package until immediately before use. After unpacking, re-seal promptly or store in decicator with a desiccant.
- d) Do not store product in bulk to prevent coils and parts being damaged.

3. Do not use or store in locations where there are corrosive gases (salt, acid, alkali, etc.).

4. Soldering condition for mounting should be within the specification range.

If overheated, a short circuit, performance deterioration, or lifespan shortening may occur.

5. When using, try to avoid excessive mechanical impact on the product such as collision / drop...etc.

6. When assembling a printed circuit board with a new mounted chip, be careful to avoid assembly deformation of the circuit board that may cause the overall or partial distortion of the circuit board such as at screw tightening position.

7. Self heating (temperature increase) occurs when the power is turned ON, so the tolerance should be sufficient for the thermal design.

8. Do not expose the products to magnets or magnetic fields.

9. If you would like to use this products for more stringent safety or reliability of performance and/or quality requirements, or its failure, malfunction or trouble may cause serious damage to society, individuals or property, or you have special requirement beyond the specification or condition in the catalogue, please contact us.

10. PCB should be designed so that products are not subjected to the mechanical stress caused by warping of the board as shown below. Bending and twisting of PCB will cause excessive mechanical stress and lead to crack in the product as well.

Products should be located in the sideways direction
(Length: $a < b$) to the mechanical stress.

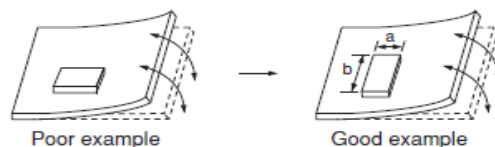

11. Cleaning brush shall not touch the winding portion of the product to prevent the breaking of wire. Cleaning could cause failure and degradation of a product.

12. Care should be taken when transporting or handling product to avoid excessive vibration or mechanical shock. Product could be damaged by external mechanical pressure, stacked under heavy object, as well as strong shaking and drop.